

USER GUIDE  
UGC005-0402

# DustBeater

DB8 and DB12 Models with MLC6 Control



Please record your equipment's model and serial number(s) and the date you received it in the spaces provided.

It's a good idea to record the model and serial number(s) of your equipment and the date you received it in the User Guide. Our service department uses this information, along with the manual number, to provide help for the specific equipment you installed.

Please keep this User Guide and all manuals, engineering prints and parts lists together for documentation of your equipment.

Date: \_\_\_\_\_

Manual Number: UGC005-0402 \_\_\_\_\_

Serial Number(s): \_\_\_\_\_

Model Number(s): \_\_\_\_\_

**DISCLAIMER:** Conair shall not be liable for errors contained in this User Guide or for incidental, consequential damages in connection with the furnishing, performance or use of this information. Conair makes no warranty of any kind with regard to this information, including, but not limited to the implied warranties of merchantability and fitness for a particular purpose.

# TABLE OF CONTENTS

---

|  |            |
|--|------------|
| <b>INTRODUCTION</b> .....                                    | <b>1-1</b> |
| Purpose of the User Guide .....                              | 1-2        |
| How the guide is organized .....                             | 1-2        |
| Your responsibilities as a user .....                        | 1-2        |
| ATTENTION: Read this so no one gets hurt .....               | 1-3        |
| <b>DESCRIPTION</b> .....                                     | <b>2-1</b> |
| What is the DustBeater? .....                                | 2-2        |
| <b>SPECIFICATIONS</b> .....                                  | <b>3-1</b> |
| Specifications .....   | 3-2        |
| <b>INSTALLATION</b> .....                                    | <b>4-1</b> |
| Loader .....   | 4-2        |
| Control .....  | 4-4        |
| Brushless Vacuum Motor .....                                 | 4-5        |
| Ratio Valve .....  | 4-6        |
| Material Tubing .....  | 4-8        |
| <b>OPERATION</b> .....                                       | <b>5-1</b> |
| General Control Operation .....                              | 5-2        |
| General Loader Operation .....                               | 5-4        |
| Single Material, Hopper Loading .....                        | 5-5        |
| Single Material, Direct Feed Loading .....                   | 5-6        |
| Two Material Loading, Hopper Loading<br>or Direct Feed ..... | 5-7        |
| Hopper Loading with<br>Positive Discharge Option .....       | 5-9        |
| Hopper Loading with<br>Remote Demand Sensor .....            | 5-10       |
| Purge .....  | 5-11       |
| <b>SETTING FEED TUBES</b> .....                              | <b>6-1</b> |
| Types of Feed Tubes .....                                    | 6-2        |
| Vertical Feed Tube Adjustments .....                         | 6-3        |
| Horizontal Feed Tube Adjustments .....                       | 6-4        |
| <b>SENSOR ADJUSTMENTS</b> .....                              | <b>7-1</b> |
| General Sensor Sensitivity Adjustments .....                 | 7-2        |
| Demand Sensors .....   | 7-3        |
| Fill Sensors .....   | 7-4        |

---

**TABLE OF  
CONTENTS**  
(CONTINUED)

**CONTROL FUNCTIONS . . . . .8-1**  
    Status Messages . . . . .8-2  
    Alarm Messages . . . . .8-3  
    Programming Messages . . . . .8-5  
    Special Programming Functions . . . . .8-8  
    Changing Operational Functions/Security Level “D” . . . . .8-9

**INPUT JUMPER SETTINGS/  
TERMINAL BOX CHANGES . . . . .9-1**  
    Use of Standard Input Devices . . . . .9-2  
    Use of Non-Standard Input Devices . . . . .9-3  
    Changing Input Device Jumpers . . . . .9-4  
    Universal Terminal Box (UTB) . . . . .9-5

**MAINTENANCE . . . . .10-1**  
    Filter Cleaning . . . . .10-2  
    Compressed Air Cleaning . . . . .10-3  
    Motor Brush Checking/Replacement . . . . .10-4

**TROUBLESHOOTING . . . . .11-1**  
    Troubleshooting . . . . .11-2

# INTRODUCTION

- *Purpose of the User Guide . . . .1-2*
- *How the guide is organized . . . .1-2*
- *Your responsibilities as a user .1-2*
- *ATTENTION: Read this so  
no one gets hurt . . . . .1-3*

---

## PURPOSE OF THE USER GUIDE

This User Guide describes the Conair DustBeater Models DB8 and DB12 and explains step-by-step how to install, operate, maintain and repair this equipment.

Before installing this product, please take a few moments to read the User Guide and review the diagrams and safety information in the instruction packet. You also should review manuals covering associated equipment in your system. This review won't take long, and it could save you valuable installation and operating time later.

---

## HOW THE GUIDE IS ORGANIZED

Symbols have been used to help organize the User Guide and call your attention to important information regarding safe installation and operation.



Symbols within triangles warn of conditions that could be hazardous to users or could damage equipment. Read and take precautions before proceeding.

---

## YOUR RESPONSIBILITY AS A USER

You must be familiar with all safety procedures concerning installation, operation and maintenance of this equipment. Responsible safety procedures include:

- Thorough review of this User Guide, paying particular attention to hazard warnings, appendices and related diagrams.
- Thorough review of the equipment itself, with careful attention to voltage requirements, intended uses and warning labels.
- Thorough review of instruction manuals for associated equipment.
- Step-by-step adherence to instructions outlined in this User Guide.

We design equipment with the user's safety in mind. You can avoid the potential hazards identified on this machine by following the procedures outlined below and elsewhere in the User Guide.



## **ATTENTION: READ THIS SO NO ONE GETS HURT**



### **WARNING: Improper installation, operation or servicing may result in equipment damage or personal injury.**

This equipment should be installed, adjusted, and serviced by qualified technical personnel who are familiar with the construction, operation and potential hazards of this type of equipment.

All wiring, disconnects and fuses should be installed by qualified electrical technicians in accordance with electrical codes in your region.

Always maintain a safe ground. A properly sized conductive ground wire from the incoming power supply must be connected to the chassis ground terminal inside the electrical enclosure. Improper grounding can result in personal injury and erratic machine operation.

Do not operate the equipment at power levels other than what is specified on the the equipment serial tag and data plate.



### **WARNING: Electrical shock hazard**

This equipment is powered by electrical voltage, as specified on the machine serial tag and data plate.

Always disconnect and lock out the incoming main power source before opening the electrical enclosure or performing non-standard operating procedures, such as troubleshooting or maintenance. Only qualified personnel should perform procedures that require access to the electrical enclosure while power is on.



### **CAUTION: Hot surfaces**

Surface temperatures inside the DustBeater can exceed 250° F (121° C). Always allow the unit to cool to below 100° F (38° C) before opening, servicing or disassembling the unit.

**NOTE:** Controls mounted to the loader are never intended to be used as a handle to lift the loader or provide balance assistance to users during maintenance, etc. Injury could result.

---

## DESCRIPTION

---

- *What is the DustBeater? . . . . .2-2*

---

## DESCRIPTION

The Conair DustBeater is a self-contained vacuum loader designed to transfer typical plastic pellets and/or regrind, by vacuum, from boxes, bins, hoppers or granulators to end-use destinations like molding machines, extruders or other hoppers or bins.

The DustBeater is available in two models: The DB8 (8 inch diameter vacuum body) and the DB12 (12 inch diameter body), each with their own motor sizes, throughput capabilities and options. The DustBeater can also be supplied in a variety of configurations, such as gravity discharge, direct feed discharge, ratio, etc, designed to match the DustBeater to your specific application.

Each model is equipped with a control box that permits virgin load time setting, regrind load time setting (should be used only if the DustBeater is equipped with a ratio valve) plus several other settings that may be summoned through the digital readout control box. The control's on/off switch is also a circuit breaker. The control box, flange mounted as standard, may be remoted to a more convenient location with the addition of the optional remote control cable and mounting bracket set.

A blowback feature, supplied to extend the operational life of the dacron filter inside the DustBeater, automatically blasts the filter clean at the conclusion of every loading cycle. When supplied, this option (plus the ratio valve option), require the connection of compressed air to the DustBeater's air filter.

# SPECIFICATIONS

---

- *Specifications* .....3-2

# SPECIFICATIONS

## SELF-CONTAINED VACUUM LOADERS DustBeater DB8 and DB12 Models

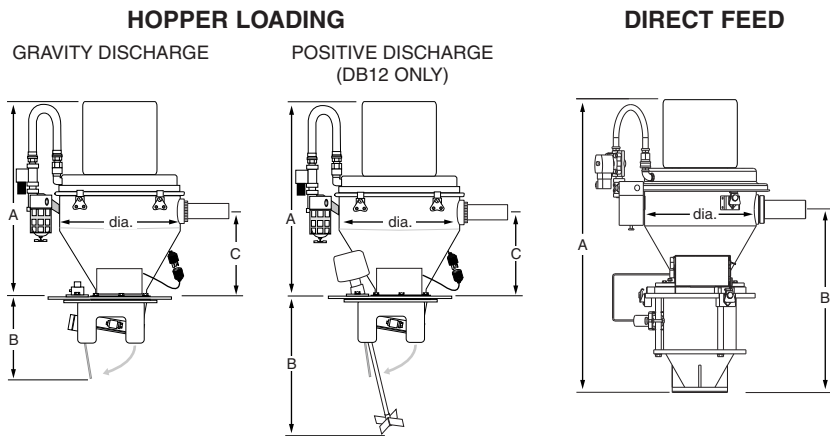

**BRUSHLESS MOTOR**

The high performance Brushless Motor plugs directly into a 120 volt, 20 amp receptacle. The control may then plug into the motor for convenience, if desired.

Loaders with brush motors operate through the control.

### DB Series Self-contained Vacuum Loaders

| Loader model                                   | DB8   | DB12           | DB12             |
|--|---|----------------|------------------|
| Vacuum motor                                   | 5/8 Hp-2 brush  | 7/8 Hp-4 brush | 1.3 Hp brushless |
| Maximum injection mold machine size            | 500 tons  | 1000 tons      | 2000 tons        |
| Maximum extruder size inches (mm)              | 2 (50.8)  | 3 (76.2)       | 4 (101.6)        |
| Recommended throughput* lbs/hr (kg/hr)         | 200 (91)  | 500 (227)      | 1000 (454)       |
| Maximum conveying distance ft (m)              | 50 (15.24)  | 75 (22.86)     | 120 (36.58)      |
| Loader diameter inches (mm)                    | 8 (203)   | 12 (304)       |                  |
| Loader volume ft <sup>3</sup> (liters)         | 0.14 (4.0)  | 0.5 (14.2)     |                  |
| Material/Vacuum line size inches (mm) OD       | 1.75 (44.45) OD   |                |                  |
| Available voltages, 50/60 Hz                   | 120/220 VAC   | 120/220 VAC    | 120 VAC          |
| Amps @ 120 VAC                                 | 8   | 14             | 17               |
| Amps @ 220 VAC                                 | 4   | 7              | NA               |
| Compressed air requirements                    | 80 psi (5.52 bar), 2 ft <sup>3</sup> /min (0.057 m <sup>3</sup> /min), NPT fitting: 3/8 in. |                |                  |
| Filter area in <sup>2</sup> (cm <sup>2</sup> ) | 50 (322.6)  | 113 (729)      |                  |
| Filter type                                    | Reinforced polyester disc   |                |                  |

FIG. 1 - DB8

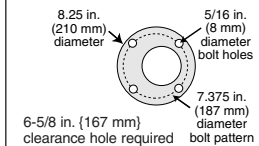

FIG. 2 - DB12

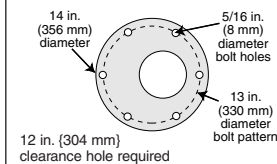
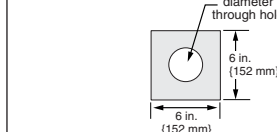

FIG. 3 - DIRECT FEED



### Hopper Loading Configuration

| Loader model                           | DB8          |  |  | DB12         |  |  |
|--|--------------|--|--|--------------|--|--|
| Dimensions inches (mm)                 |              |  |  |              |  |  |
| A - Height above mounting plate†       | 16 (406)     |  |  | 22 (559)     |  |  |
| B - Depth below mounting plate         | 5.5 (140)    |  |  | 9 (229)      |  |  |
| with positive discharge                | NA           |  |  | 16 (406)     |  |  |
| C - Height to center of material inlet | 6.2 (157.5)  |  |  | 9.5 (241)    |  |  |
| Mounting details                       | See FIG. 1   |  |  | See FIG. 2   |  |  |
| Installed weight lb (kg)               | 27.4 (12.43) |  |  | 48.8 (22.14) |  |  |
| Shipping weight lb (kg)                | 50 (22.68)   |  |  | 65 (29.48)   |  |  |

### Direct Feed Configuration

| Loader model                           | DB8          |              |              | DB12         |              |               |
|--|--------------|--------------|--------------|--------------|--------------|---------------|
| Viewing chamber model                  | 4 lb         | 15 lb        | 25 lb        | 4 lb         | 15 lb        | 25 lb         |
| Viewing chamber capacity lb (kg)‡      | 4 (1.81)     | 15 (6.8)     | 25 (11.3)    | 4 (1.81)     | 15 (6.8)     | 25 (11.3)     |
| with isolator valve†                   | 3 (1.36)     | 11 (4.99)    | 21 (9.53)    | 3 (1.36)     | 11 (4.99)    | 21 (9.53)     |
| Dimensions inches (mm)                 |              |              |              |              |              |               |
| A - Height above mounting plate†       | 27.8 (706.1) | 33.3 (845.8) | 83.8 (2129)  | 33.8 (858.5) | 39.3 (998.2) | 89.8 (2281)   |
| B - Height to center of material inlet | 18 (457.2)   | 23.5 (596.9) | 74 (1880)    | 21.3 (541)   | 26.8 (680.7) | 77.3 (1963)   |
| Add for isolator valve                 | 0            | 0            | 0            | 2.25 (57)    | 2.25 (57)    | 2.25 (57)     |
| Mounting details                       | See FIG. 3   |              |              |              |              |               |
| Installed weight lb (kg)               | 52.4 (23.77) | 54.4 (24.68) | 85.4 (38.74) | 73.8 (33.48) | 75.8 (34.38) | 106.8 (48.44) |
| Shipping weight lb (kg)                | 80 (36.29)   | 84 (38.10)   | 117 (53.07)  | 108 (48.99)  | 110 (49.90)  | 144.8 (65.68) |

### SPECIFICATION NOTES

\* Throughputs beyond the recommended ratings should not be attempted unless you are conveying virgin material from close distances. Higher throughputs could result in shortened brush and/or filter life. For higher throughputs, consult Conair for a quote on central vacuum loaders.

† Add 3 inches (76.2 mm) to height if using sound shield option.

‡ At 35 lbs. per ft<sup>2</sup>. (15.88 kg)

All DustBeaters are shipped with 10 ft. (3.048 m) of flexhose and a vertical feed tube.

Specifications can change without notice. Contact your Conair representative for the most current information.

# INSTALLATION

- *Loader* .....4-2
- *Control* .....4-4
- *Brushless Vacuum Motor* ..4-5
- *Ratio Valve* .....4-6
- *Material Tubing* .....4-8

# LOADER INSTALLATION



Hopper Loader



Direct Feed Loader

## Hopper Loading Configuration:

A hopper loading DustBeater is equipped with a discharge valve on the bottom that allows the loader to be vacuum sealed while it is loading.

Typical installations place this discharge valve down into the top of the hopper to be filled, by utilizing the loader's mounting flange, located above the discharge valve, as the interfacing surface with the hopper the loader will fill. An appropriately sized hole in the destination hopper is required for this mounting (*see Specifications, section 3, Figure 1*). The loader, once inserted into this mounting hole, may be either bolted into place with 1/4-20 bolts through the supplied bolt holes around the perimeter of the loader's mounting flange, or it may be secured with hold-down clips, tightened against the mounting flange. Most Conair hoppers are already supplied with these hold down clips (and an appropriately sized hole) for this type of mounting.

**TIP:** Gasket material (not supplied) may be installed between the mounting flange of the loader and the receiving hopper to assure a dust-free seal, but it is not required for normal loader operation.

## Direct Feed Configuration:

A direct feed DustBeater is equipped with a sight glass on the bottom in lieu of the more traditional discharge valve. This sight glass is mounted to an aluminum casting that funnels the conveyed material directly to the machine throat, eliminating typical machine hoppers. Dimensions of the base are shown in *Specifications, section 3, Figure 2*.

With direct feed discharge, the DustBeater may be surface mounted directly to the device that will receive the material (usually a machine throat). A gasket is provided to assure that this connection is as airtight as possible. If connecting to a Conair supplied piece of equipment, the cast aluminum base of the sight glass may already be drilled so it may be bolted easily to the equipment. If the equipment is not Conair (i.e.: a molding machine or extruder throat), the cast aluminum base of the direct feed sight glass will have to be carefully match-drilled to interface with the machine. The gasket will have to also be custom fitted for this interface.

Note that typically, the joining of a direct feed sight glass to a processing machine throat (or other equipment) requires that all equipment is airtight, to assure a good vacuum seal when the loader attempts to vacuum convey material to the loader. Traditional molding machine or extruder throat accessories like swing arms, slide gates, starve feeding screws, drawer magnets, drain ports, liquid colorant additive adapters and other such devices are not air tight and must either be removed for proper loader operation, or the loader must be equipped to compensate for these accessories. A standard DustBeater option to overcome the lack of a good vacuum seal at the base of the direct feed loader is an isolation valve, installed on the loader, within the top of the sight glass. This isolation valve works exactly like a gravity discharge valve and closes when vacuum is created by the vacuum motor of the loader and assures a good vacuum chamber for conveying material to the loader. It is advisable to check to see if an iso valve is required and/or supplied, before beginning installation of the DustBeater.

The direct feed sight glass of the loader is detachable from the rest of the loader by releasing the three clamps located around the top of the sight glass. This simplifies the installation by reducing the size and weight of the machinery to be installed. Once the sight glass section is installed, the rest of the loader may be reclamped in place, to finish the installation.

## LOADER INSTALLATION (CONTINUED)

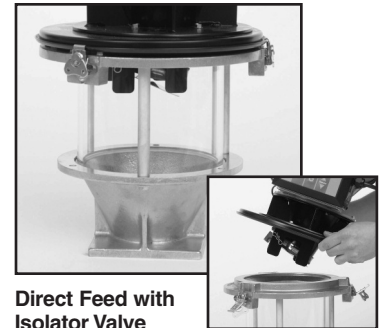

Direct Feed with  
Isolator Valve

# CONTROL INSTALLATION

**NOTE:** Controls mounted to the loader are never intended to be used as a handle to lift the receiver or provide balance assistance to users during maintenance, etc. Injury could result.

Flange mounted controls are already mounted directly to the loader's terminal box, on the flange of the loader, and pre-connected to all loader functions. No further work is required, other than connecting the power cord to an appropriate electric power receptacle. Special considerations must be made when employing the optional Brushless Motor option, see *Brushless Vacuum Motor, section 4-5*.

Remote controls consist of a separate control box which may be temporarily mounted to the loader's terminal box for ease of shipping but must be installed independent of the loader installation. If installed on the loader terminal box, the control may be released by prying it free of the loader's terminal box with a screwdriver. First, disconnect the umbilical cable that connects the control to the loader's terminal box by depressing the small metal tab on top of the umbilical's connector. Then, insert a screwdriver between the terminal box and the control box from the underside and twist. Once the bottom of the control is pried free of the terminal box, the control box may be slid sideways, to the right, off of the terminal box's integrated mounting lip that holds the two boxes together at the top. Once removed, the control may be located wherever convenient, using the remote control mounting bracket (shipped separately), and connected to the terminal box via an optional remote control cable (also shipped separately), see *Specifications, section 3*.

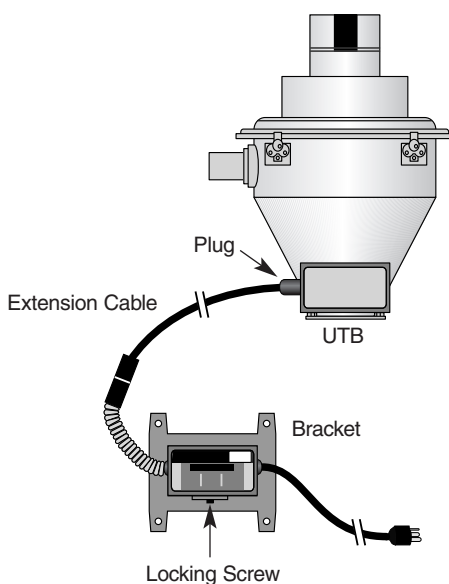

The separate remote control mounting bracket provides the ability to mount the control where desired. Mount the bracket to any firm vertical surface, locating the locking screw at the bottom of the bracket. Then insert the control so that the tabs of the bracket interface with the top extrusion detail of the control and swing the control into the bracket and secure the bottom with the small screw. Be sure to locate the control within the length of the supplied cable and route the cable away from hot surfaces or moving parts. Cables may be joined together for longer remote control distances.

Once installed, the power cord may be connected to the appropriately equipped power receptacle. Amperage rating and voltages are listed in the specification section of this manual.

The brushless motor option, because of its higher horsepower rating and greater conveying power, requires special electrical considerations. Twenty (20) amp power must be provided directly to the motor via its own power cable. The motor is also equipped with a small green plug that must be connected into the “Load” receptacle on the terminal box of the loader.

With this arrangement, higher amperage power is connected directly to the motor and the small terminal box plug allows this power to be turned on and off in response to the needs of the DustBeater control. The junction box of the brushless motor also contains an auxiliary receptacle that provides a place where the DustBeater control may be plugged in for convenience or the control may be plugged in separately as desired. The convenience receptacle should not be used for any other equipment or appliances, besides the loader control.

Separate circuit breaker protection is provided in the top of the brushless motor junction box to protect the motor circuit and the convenience receptacle.

## BRUSHLESS VACUUM INSTALLATION

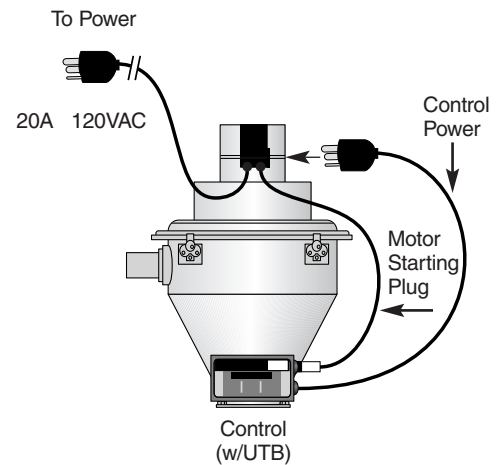

# RATIO VALVE INSTALLATION

DustBeaters equipped with a ratio valve (for loading regrind, along with virgin material) may require installation of the valve, which may be shipped separately.

The ratio valve installs easily on the material inlet tube of the loader by connecting the valve's singular outlet tube over the inlet stub. The valve must be oriented with the flat clean-out door oriented 'up' and the dual inlets of the valve oriented horizontally. Push the valve onto the loader inlet tube as far as it will go. The screws supplied on the valve's outlet coupling should be tightened only firm enough to hold the valve in place. Do not over tighten, or the loader's inlet tube may be deformed, creating vacuum leaks.

The green connector on the end of the electrical cable of the ratio valve should be connected to the receptacle on the right side of the loader's terminal box labeled "ratio".

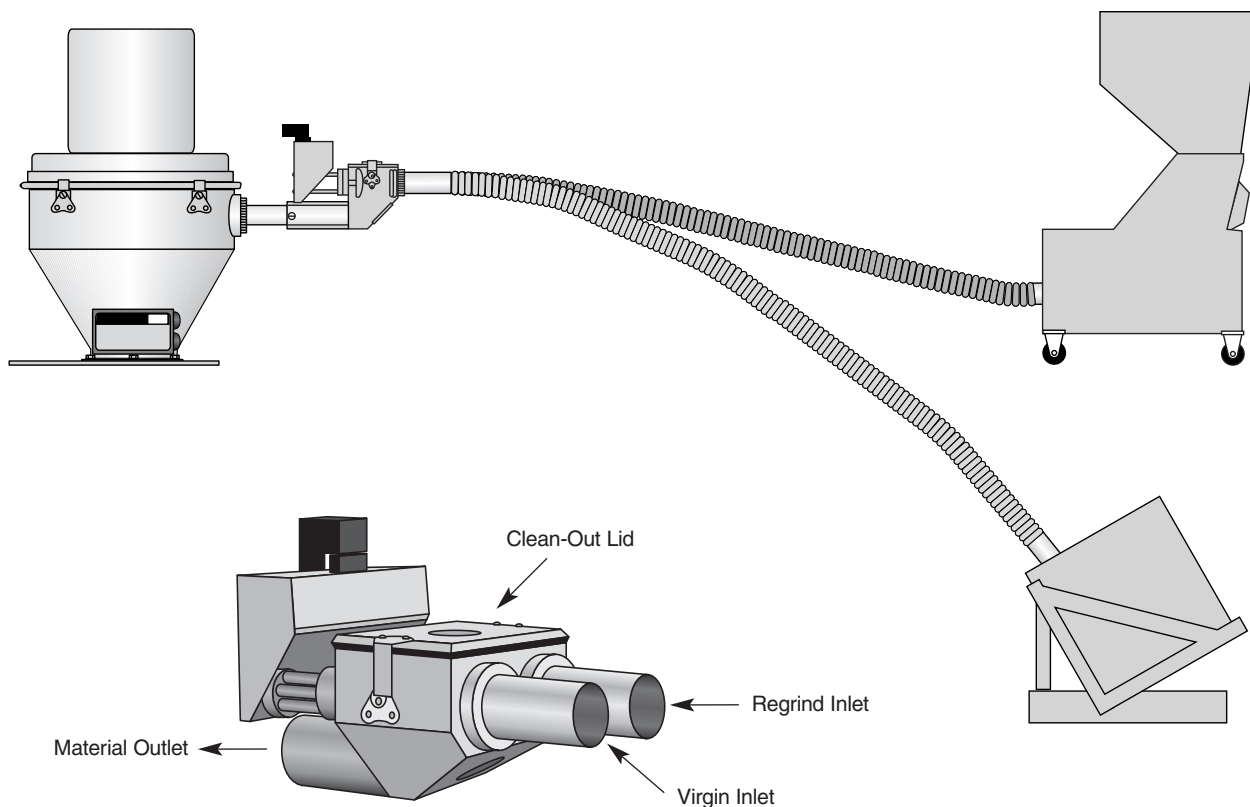

---

## **RATIO VALVE INSTALLATION**

**(CONTINUED)**

The air line of the ratio valve must be connected to the air manifold of the loader, located directly behind the large inlet air filter. A brass, quick disconnect fitting is supplied either already installed on the manifold, or on the ratio valve's air line. If the fitting is not supplied on the manifold, a pipe plug will have to be removed and the fitting installed into the manifold. Thread sealant may be used to encourage a leak-proof connection, but use it sparingly to prevent unwanted excess within the compressed air system. With the fitting installed firmly in the manifold, the air line from the ratio valve may be easily slipped into the fitting to complete the installation. A gentle tug on the tubing will assure that it is properly seated in the fitting.

Note that the ratio valve may be located elsewhere if desired. As long as it is oriented horizontally (with the clean-out door on top) and is within the distance parameters of the loader's capability, the valve can be moved to the most convenient location. The electrical connection will usually have to be extended (extension cable sets are available from Conair) and the air line will have to be extended, for the new location.

---

# MATERIAL TUBING INSTALLATION

**NOTE:** Flex hose is typically considered a wear item, so it should not be routed or secured in such a way as to make replacement difficult. Flex hose should not be routed close to electrical wires, especially control signal wires since static electricity, commonly generated by conveyed material can be discharged to the wires, fouling electrical operation.

**TIP:** Rigid tubing like aluminum and stainless steel will last much longer and provide a straighter path for material flow, usually increasing the loader's ability to convey material. When employed, rigid tubing should be coupled tightly to prevent air leaks, should be routed to minimize bends, and should be supplied with flex hose at the loader end to allow quick disconnection of the loader, if ever needed.

Typical DustBeater installations use flex hose to connect the material inlet(s) of the loader to the material source(s). Flex hose may be fitted over the inlet stub of the loader or the dual inlets of the ratio valve and secured with hose clamps (supplied). The hose should be fitted over the inlet stub at least 1 1/2 inches. Flex hose should be routed away from hot surfaces and should be as straight as possible to avoid conveying problems. Twists in the hose, which dramatically reduce conveying performance, should be avoided.

For loaders equipped with ratio valves, the dual material lines (usually virgin and regrind) must be connected to the proper inlet tubes of the ratio valve. The inlets are identified on the ratio valve as "V" for virgin (on the left) and "R" for regrind (on the right). These inlets coordinate with the control signals coming from the loader's control box.

Connection to the materials source's feed tubes or distribution boxes is done in a similar manner as connection to the loader. Once again, route the hose to avoid loops, kinks and hard bends that will cause the hose to wear prematurely. When connected to vertical feed tubes or wands (used for conveying out of open-top boxes) sufficient slack should be left to allow movement of the feed tube when the material supply gets low, but "valleys" or droops in the hose should be avoided. Hose clamps should be installed to prevent disconnection of the hose from the source feed tube.

# OPERATION

- ***Control Operation . . . . .5-2***
- ***Loader Operation . . . . .5-4***
- ***Single Material,  
Hopper Loading . . . . .5-5***
- ***Single Material,  
Direct Feed Loading . . . . .5-6***
- ***Two Material Loading,  
Hopper Loading or  
Direct Feed . . . . .5-7***
- ***Hopper Loading with  
Positive Discharge Option . . . .5-9***
- ***Hopper Loading with,  
Remote Demand Sensor . . . . .5-10***
- ***Purge . . . . .5-11***

# CONTROL OPERATION



MLC6

Conair’s digital read-out controls provide the greatest of reliability, ease of use and full featured operation. Its text window is back-lit to provide easy visibility and when illuminated, indicates that the control is “on”. The text window provides not only the ability to program the loader’s operations but also actively displays control functions as they occur. Alarm conditions are also displayed if and when they occur, accompanied by the front panel’s alarm light.

A combination on/off/reset switch and circuit breaker is located on the right side of the control.

A wide variety of control functions are built into every control and these functions may be employed as needed through the manipulation of the three simple buttons on the control’s front face. The square button, with the circular arrow symbol is called the “function” button and allows the user to “page” through all of the available functions of the control, one at a time. The functions will be displayed on the text window as they are selected. As the function button is pressed, the function list will repeat once all of the available functions have been paged through, as suggested by the symbol on the function button. Note that many functions are ‘hidden’ from view, until the appropriate “security level” is accessed.

Up and down arrows are also supplied on the control face and allow programmed settings to be increased or decreased. In addition, combinations of these three buttons are used to access different modes of the control’s operation..

Four “Security Levels” (A, B, C and D) are built into the control that permit both easy viewing of common operating parameters, but also prevent unauthorized and/or unintentional changes being made to lesser-used or more critical loader functions. Security levels “B” and “C” are accessed by pressing the “function” and “up” button simultaneously, whenever the control is turned on. While in each security level, changes may be freely made as needed, modes changed, etc. If no changes are made within 10 seconds, the control will default back to Security Level “A”, providing only a display of virgin and regrind times, with no ability to make changes..

The following chart shows what parameters and capabilities are available at each Security Level and what steps are required to switch between these levels:

## CONTROL OPERATION (CONTINUED)

|                           |  |   |  |
|---------------------------|--|---|--|
| <b>Security Level “A”</b> | For viewing (only) of virgin and regrind vacuum-on time settings (no changes can be made).   | May be seen by pressing the function button from the status display screen.   | This may be the only function required by processing floor personnel to confirm loader settings (only)   |
| <b>Security Level “B”</b> | Displays and allows changes to be made to virgin and regrind time settings.  | May be accessed from the Status display or Level A by pressing the function and up arrow buttons at the same time.    |  |
| <b>Security Level “C”</b> | Displays and allows changes to be made to the virgin, regrind, unload (vacuum off) and purge times, the number of blowback pulses, regrind layers, and alarm settings. | May be accessed from Level B by pressing the function and up arrow buttons at the same time.                          | If attempting access from Level A, Level B must be accessed first.   |
| <b>Security Level “D”</b> | Provides the ability to change the operating characteristics of the control and use (or not) of a fill sensor.   | May be accessed by pressing the function and down arrow buttons at the same time and holding them both for 5 seconds. | <b>CAUTION:</b> Security Level D makes radical changes in the way the control operates and should not be entered without a full understanding of operating parameters. |

A complete set of operating parameters accompanies each mode of operation of the DustBeater’s capabilities.

**See Control Functions, Settings and Readouts, section 8,** for a complete listing of all of the details of each mode of operation; but note that the control is programmed to allow the user to make only logical programming choices in each mode of operation. The control is designed to accommodate standard loader functions and may be depended upon to perform logically, unless used in a manner inappropriate to its design.

---

# LOADER OPERATION

Loading is accomplished by inserting the feed tube(s) into the material supply, turning on the control, allowing material to flow into the loader and adjusting the virgin (and/or regrind) load time as described below. The flow of material may be optimized by adjusting the feed tube's "air to material" settings covered in the *"Feed Tube Settings", section 6*. Start of the loading function is triggered by the demand switch, integrated into the gravity discharge valve on the bottom of the loader (or provided as a separate switch). On a "hopper loader", when the flapper on the loader is closed by its own counterweight, it is an indication that the loader 'sees' no material below it and must provide material by starting a load cycle. The standard demand switch is a "reed" type that magnetically interacts with a small magnet, located on the flapper weldment. As the flapper closes and the magnet gets close to the reed switch, the switch closes, providing a demand signal to the loader control. From that point, the loader control's timed functions take over, providing a complete load cycle with the vacuum motor, filter cleaning blowback function, etc. Other demand switch types include capacitive sensors.

After discharging material into the receiving hopper below the loader, the cycle may repeat or the discharge flapper may be held open with the material that was discharged from the loader. If the flapper closes, the cycle will repeat. If the flapper is held open by the material, it is an indication that there is no need for another load cycle and the loader will wait until the material level falls, the flapper closes, the magnet comes close to the reed switch and triggers another load cycle.

The DustBeater is capable of operating in several different modes, based upon the options that were supplied. The following instructions explain these modes, starting with the most common versions.

---

## SINGLE MATERIAL, HOPPER LOADING OPERATION

In this configuration, the only control settings required by the user are the input of “virgin secs” plus feed tube settings (known as “air-to-material” settings). Feed tube settings are covered separately under “*Setting Feed Tubes,*” *section 6.*

Virgin seconds may be input at Security Level B by simply using the up or down arrow buttons to adjust vacuum-on time accordingly. The loader comes equipped with a factory preset of 30 seconds. Load time should be set with enough seconds to ‘just fill’ the vacuum loader. ‘Just full’ is indicated by an audible rise in pitch of the vacuum motor and/or material no longer flowing in the material conveying line. Too much loading time will prematurely wear out the vacuum motor, pack material in the conveying line, prematurely blind the filter and possibly cause material shortages by wasting valuable vacuum time by attempting to fill a loader that is already full. Too few seconds set on the control may starve your process with numerous on and off cycles that yield too little material transfer.

Often times, virgin load time is best adjusted by trial and error, to provide sufficient vacuum-on time to “just fill” the loader before the motor shuts off.

If your DustBeater is equipped with a “fill sensor” (a capacitance sensor, mounted in the loader body), the load time should be set slightly higher than typical load time, since the fill sensor will terminate vacuum loading once it ‘sees’ material in the loader, during loading. In this way, a correctly adjusted fill sensor will optimize loading cycles automatically. In addition, the DustBeater control will provide an ‘alarm’ signal (plus an alarm output) if the fill sensor does not see material by the time the load time setting expires. To avoid nuisance alarms, the load time setting should be set amply more than the required number of seconds it takes to fill the loader. *See Alarms Messages, section 8,* for more information on alarms and alarm settings. Note that the fill sensor must be adjusted for proper sensing of the loaded material, *see Sensor Adjustments, section 7.*

Additional control settings are provided within the control that are factory set to common parameters but are accessible and changeable via Security Level “C”. See the “Unload” and “Blowback” control sections for more information, but the factory settings of these parameters are usually very acceptable for most operations and do not need further adjustment.

---

# SINGLE MATERIAL, DIRECT FEED LOADING OPERATION

Direct Feed DustBeaters operate exactly the same as Hopper Loading versions, but may include a sensor on the sight glass base. Follow all of the guidelines listed above under “Single Material, Hopper Loading” and then refer to the “Sensor Adjustments” section to properly adjust the demand sensor located on the direct feed sight glass. Once in operation, the sight glass material level may be adjusted by moving the demand sensor on the sight glass up or down, to provide a larger or smaller reservoir of material on the machine throat. Material level may be minimized if the material has been dried and you wish to minimize the possibility of moisture regain or if you desire quick material changes with minimal leftover material in the glass. Material level may be increased if the shot size or throughput rate of the process requires a greater ‘on hand’ supply of material.

If the DustBeater is equipped with an “Isolator Valve” (a small flapper valve below the loader section and inside the top section of the sight glass), the DustBeater may be using an integrated ‘reed’ switch within that flapper assembly to provide demand sensing and no external sensor is supplied.

In this case, the material level in the sight glass will be determined by the isolator valve’s flapper position and no level adjustment within the glass is possible. Note that some models may include both an isolator valve and a height-adjustable sensor. In this case, the sensor holder will be restricted from being raised to within sensing range of the isolator valve, to prevent erroneous signals from occurring by the sensor being triggered by the iso valve.

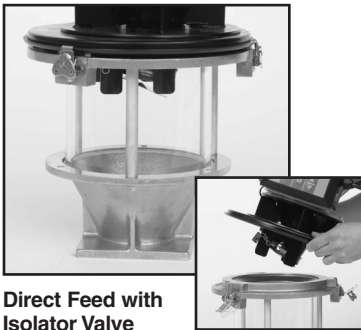

Direct Feed with  
Isolator Valve

Follow all guidelines listed above under “Single Material Loading”. The operational parameters are exactly the same, except that the operator will now be loading two materials during the vacuum on cycle through the use of the ‘ratio’ function and a ratio valve mounted on the inlet of the loader.

Two control settings govern the operation of the ratio valve: The “regrind seconds” (listed as REGRIND SECS and accessible through Security B) and “regrind layers” (listed as REGRIND LAYERS and accessible through Security Level C).

The regrind seconds setting simply adds additional load time to the operation of the loader to allow for the appropriate amount of time to be dedicated to transferring regrind material. In operation, virgin seconds (VIR SECS) plus regrind seconds (REG SECS) totals the overall vacuum-on time of the loader’s vacuum motor. Both of these values are viewable in Security Level A, by simply pressing the function button and changeable in Security Level B.

The regrind layers setting provides an alternating of the virgin and regrind plungers of the ratio valve as material is loaded, so that materials are somewhat mixed as they enter the loader. Based on this setting, the control will use the time settings established for virgin and regrind and alternate the valve as many times as set on the regrind layers setting indicates during the course of each loading cycle. This setting is viewable and changeable in Security Level C.

To make selecting the appropriate number of layers as easy and logical as possible, a “default” setting (“D”) is provided that uses the regrind seconds setting to determine a logical number of layers for the ratio valve. This feature allows the user to select either “D”, where the control will decide how many layers should be employed, or you may input a number between 1 and 5, where the virgin and regrind time settings are ignored and the ratio valve will switch the number of times selected. The use of the default “D” selection is encouraged unless special conveying parameters are required.

**IMPORTANT:** It is highly recommended that the ratio function be employed only for applications that allow the full use of all regrind as it is generated.

## TWO MATERIAL LOADING, HOPPER LOADING OR DIRECT FEED OPERATION

**NOTE:** The ratio function of any loader, including the DustBeater, should not be relied upon for accurate proportioning of materials. The loader takes responsibility for providing the air flow required for vacuum loading plus opening and closing of the ratio valve in the approximate time sequences as set on the controls. The loader has no way of interpreting the differences in material bulk density, flow characteristics and conveying distances that can all affect the delivery of the desired proportions of each material. In fact, the loader cannot determine if material is even flowing through each conveying line. Adjusting and compensating for these parameters are the responsibility of the user.

---

# **TWO MATERIAL LOADING, HOPPER LOADING OR DIRECT FEED OPERATION**

**(CONTINUED)**

In this case, the ratio function provides a valuable asset to users, by efficiently loading an approximate proportion of regrind along with virgin materials.

Virgin time (VIR SECS) will usually need to be adjusted with the use of the regrind time (REG SECS), to compensate for the stop/start cycling of each material as the ratio valve switches and to compensate for the differences in flow characteristics between virgin and regrind. Conveying distance differences must also be taken into account. Sluggish material conveying characteristics can prohibit the use of too many layers. Observing both the sight glass windows on the ratio valve and the material flow in the flex hose will help to guide the simple adjustments to achieve your desired ratio loading performance.

---

DustBeaters equipped with positive discharge valves (DB12 only) operate exactly the same as other models, but instead of simple gravity discharging their load of material at the conclusion of loading, the discharge valve is ‘driven’ open by an air cylinder affixed to the flapper. The duration of this discharge valve open cycle is controlled by the “vacuum off” setting (shown and adjustable in Security Level C as “OFF SECS”) and may be adjusted as needed to provide more or less valve open time. The amount of “off time” the loader is set for will provide the amount of positive discharge valve open-time.

## **HOPPER LOADER OPERATION WITH POSITIVE DISCHARGE OPTION**

Loaders with Positive Discharge valves do not employ integrated demand reed switches on their discharge flappers nor demand sensors, but instead employ rotary switches to sense the level of material in the hopper below the loader and provide a demand signal. The rotary switches are equipped with a motor driven paddle that when stopped by material, indicates a full hopper below the loader (no demand). When the paddle is allowed to move freely, it is an indication of no material and a demand signal is provided to the control. Rotary switches are provided with long shafts to allow the material sensing (paddle) area to be located far enough below the loader to prevent any material interference with the positive discharge valve’s opening and closing motion.

With the positive discharge feature included, material is more likely to flow easily out of the loader without relying on the material weight to push open the discharge valve. This feature also helps in the loading of hoppers that may contain pressurized air (like high CFM drying hoppers) that may restrict the free motion of gravity discharge flappers.

---

# HOPPER LOADER OPERATION WITH REMOTE DEMAND SENSOR

DustBeaters equipped with a remote demand sensor operate exactly the same as other hopper loading models, but use a capacitance demand level sensor connected to the loader terminal box via a long cable with a plug, versus other methods of demand level sensing. These remote sensors provide the ability to trigger a load cycle from a user-defined location instead of directly below the loader. This option is very useful for drying hopper or blender supply hopper applications where the user can define exactly how much of the hopper will be filled (by the location of the sensor) instead of always filling the hopper to the top. These remote demand sensors are commonly installed to sense the material level through a sight glass and must be adjusted to “ignore” the glass, yet “see” the material inside the hopper, *see Sensor Adjustments, section 7*. If the length of cable supplied with the remote demand sensor is not sufficient to reach your desired sensing location, extension cables are available from Conair.

In some cases, it may be desirable to utilize the remote demand sensor option alternately with the integrated demand switch or other sensing method. In these cases, the remote demand sensor may be simply unplugged from the loader’s terminal box and substituted with the alternate sensing device. Note that the loader will not operate without a demand switch input provided to the terminal box.

DustBeaters utilizing the purge option provide a material valve signal and a lengthening of the vacuum motor's running time designed to evacuate the conveying line of material. This feature is controlled by settings accessible through Security Level C called "PURG SECS". This purge setting extends the vacuum-on time, beyond the virgin and regrind settings. In operation, virgin seconds (plus regrind seconds, if used) plus purge seconds totals the overall vacuum motor on-time of the loader. In sequence, the loader's vacuum motor will operate for the duration set on the virgin (and regrind, if used) time settings. Then, an output signal is provided at the terminal box's "purge" output receptacle designed to actuate a material valve to shut off the inlet of material into the conveying line, while the vacuum motor continues to run for the duration set with purge seconds. If the purge seconds are set to zero, there is no extension of the vacuum load time.

The material valve used for purging is very similar in construction to the ratio valves used for loading regrind along with virgin material, but it is equipped with an air inlet filter on the valve's left inlet. The right inlet is plumbed to the material source and the singular outlet is plumbed to the loader. During normal loading, the purge valve allows material to pass from the material source, plumbed to the right inlet, through to the loader. At the conclusion of normal load time, purge time is started and the purge signal output switches the valve to shut off the material inlet but allows the vacuum motor to continue to run for the duration of the purge time setting. During this time, air flows through the purge valve's filter and 'chases' the material in the conveying line on through to the loader, purging the line clean. Once purge time expires, the loader proceeds with its standard, blowback/unloading functions and the purge valve returns to its material-line-open state.

## PURGE OPERATION

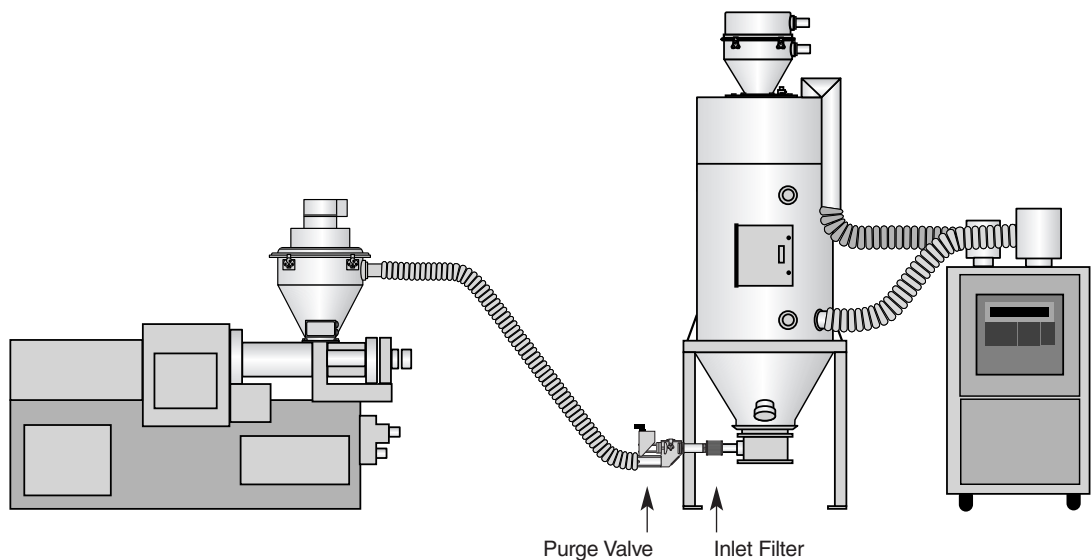
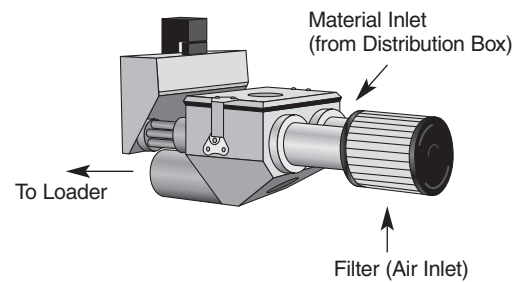

---

# **PURGE OPERATION**

**(CONTINUED)**

Note that when the purge option is utilized, virgin (and regrind, if used) time settings must allow enough room in the vacuum loader for the material that will enter during the purging phase of operation. The use of a fill sensor is not recommended. Through trial and error settings, the virgin time and purge time settings must be coordinated to assure an adequate load of material into the conveying line during the normal loading cycle and then sufficient purge time to allow the material to be pulled with vacuum air into the loader body. The longer the conveying line, the more purge time will be required. If too much virgin time is set, there is a chance that material may actually stay, or even be packed into the conveying line, instead of being purged. With too little load time, the material line may be easily cleared of material, but the loader may not be adequately filled to maintain production.

---

# SETTING FEED TUBES

- *Types of Feed Tubes* .....6-2
- *Vertical Feed Tube  
Adjustments* .....6-3
- *Horizontal Feed Tube  
Adjustments* .....6-4

---

## TYPES OF FEED TUBES

Feed tubes may be provided in a variety of styles made to match the needs for your production. Whether they are horizontal types like distribution boxes (take off boxes) or horizontal bin tubes, or vertical types like wands that are made to be hand inserted into material bins, they need to be adjusted for their air-to-material ratio. Conair provides vertical feed tubes that provide a fixed amount of material entry with adjustments for air flow and horizontal types with fixed air flow and adjustments for regulating material entry.

Smooth material flow is controlled by opening or closing the holes at the top of the feed tube, either with the flex hose connected to the feed tube or with strong tape (duct tape is commonly used).

Start by inserting the feed tube into the supply of material and observing its conveying action. If the material surges (“gulps” as it is conveyed), clear the line by lifting the feed tube out of the material supply and allowing the line to clear. Then cover holes on the feed tube and retest until the material conveys smoothly. Covering all holes conveys the maximum amount of material with minimal air, producing the highest volume of material flow but at the slowest possible conveying speed (a low air-to-material ratio). This can make conveying over longer distances or through bends more difficult. With holes uncovered, a ‘thinner’ flow of material is achieved and the greatest conveying speeds are realized. This is a high air to material ratio and can create undesirable material fracturing in the loader, “angle hair” in the conveying lines and material dust.

Test several cycles to achieve the desired results by covering or uncovering feed tube holes. Once conveying is fine tuned, the feed tube should be twisted in its conveying hose to place the open feed tube holes up, so that material cannot fall out of the holes when conveying stops.

## VERTICAL FEED TUBE ADJUSTMENTS

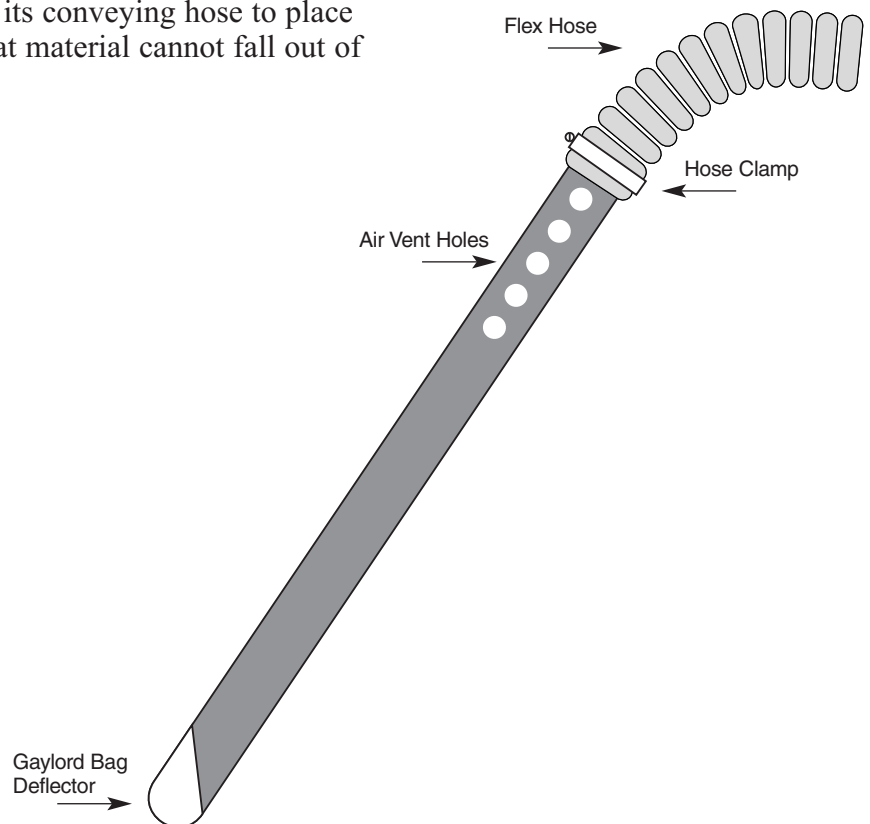

---

# HORIZONTAL FEED TUBE ADJUSTMENTS

**NOTE:** *As described in “Types of Feed Tubes”, different types of feed tubes feed material mixed with air in different ways. Conair horizontal feed tubes (distribution boxes, etc.) provide adjustments for material flow with a fixed amount of conveying air for optimum material flow. Competitive units may not work in the same manner.*

Start by loosening the thumb screw next to the adjustable air inlet tube and push it all the way in, closing off material flow and allowing 100% air to flow through to the loader. Over the course of several cycles, pull the air tube out slowly until optimum conveying is achieved with minimal surging (gulping). If surging does occur, clear the conveying line by pushing the air inlet tube all the way in until the line clears and trial and error settings may be attempted again.

Once optimum settings are achieved, the air inlet position may be locked into position with the thumb screw.

---

# SENSOR ADJUSTMENTS

- *General Sensor Sensitivity Adjustments . . . . .7-2*
- *Demand Sensors . . . . .7-3*
- *Fill Sensors . . . . .7-4*

---

# GENERAL SENSOR SENSITIVITY ADJUSTMENTS

Capacitive Level Sensors use their own on-board electronics to sense the presence or absence of material located in front of the flat face of their cylindrical bodies and trigger loader control functions as a result. Typical uses are as fill sensors, to indicate a full loader condition and terminate the loading cycle and demand sensors, which start loading by indicating the absence of material in a bin or sight glass. Before use, the control must be set to accept and operate with the specific sensor model being used and the sensor must be set to detect the material being conveyed and to ignore the sensor's surroundings (metal, sight glasses, etc.) as well as set to ignore material dust that may collect on the sensor face. In some cases, sensors must be readjusted for each new material being conveyed.

## **General Sensor Sensitivity Adjustments**

Every sensor is equipped with a multi-turn screwdriver adjustment, located within a small hole on the corded end of the sensor body. Most are also equipped with an indicator light to signal response by the sensor. With the sensor in the correct position for operation, *see Demand Sensors, section 7-3*, the adjustment screw can be rotated clockwise for more sensitivity and counter-clockwise for less sensitivity. The small signal light on the sensor illuminates when the sensor does not "see" material. As a guide, the light will go off, when the sensor detects something in front of its face. It should be adjusted to ignore glass and adjacent surfaces and fine tuned to respond only to the presence of material. This may require several back and forth adjustments to optimize the setting.

---

Demand sensors are utilized in two different ways: In direct contact with material or through a sight glass.

## DEMAND SENSORS

When coming in direct contact with material, it is recommended that the sensor be initially adjusted for sensitivity and then re-adjusted, once the sensor becomes coated with typical material fines, common to plastics conveying.

Sensors that sense material through glass or plastic windows must be adjusted to “ignore” the window and sense only the material on the other side. These adjustments must be made with the material to be conveyed, so it is suggested that they are made during normal operation. Furthermore, the sight glasses may become coated with a certain build-up of plastic dust (from static electricity attraction, etc) and the sensor should be adjusted (and/or re-adjusted) to ignore this condition. Sensors that are mounted in movable brackets that allow different levels to be set must maintain the same distance setting from the sight glass to assure consistent operation, or be reset for sensitivity. Optimum distance from the sight glass for a sensor is the thickness of a piece of paper. This setting permits the closest possible contact with the glass or window, yet is back just enough to be isolated from heat variations that could effect sensor operation.

---

## FILL SENSORS

Fill sensors are installed right in the loader body and come in direct contact with material, as it is being loaded. If set correctly, the time the material contacts the sensor is brief, since loading is terminated by the sensor and unloading usually occurs immediately afterwards. If possible and practical, the loader's unload function may be interrupted by holding the discharge valve closed, long enough to set the sensor's sensitivity. If not possible, trial and error settings may be made during repeated loads to set the sensor to terminate the loading cycle. As with other sensor adjustments, it is recommended to check the setting after the loader has operated for a period of time, and re-adjust it if need be, to allow the sensor to 'ignore' material dust that may have collected on the sensor face.

---

# CONTROL FUNCTIONS

- *Status Messages* . . . . .8-2
- *Alarm Messages* . . . . .8-3
- *Programming Messages* . . . . .8-5
- *Special Programming  
Functions* . . . . .8-8
- *Changing Operational  
Functions/  
Security Level “D”* . . . . .8-9

---

# STATUS MESSAGES

These messages will automatically appear as the functions take place in normal operation.

## **READY: NO DEMAND**

This status message indicates that the control is turned on, but there is no need for loading (no demand) at the loaders demand level switch (reed switch, demand sensor below the loader or rotating level switch)

## **LOADING MATERIAL**

This status message indicates that the loader's vacuum motor is operating and the loader should be moving one material (virgin or regrind) into the loader.

## **LOADING VIR + REG**

This status message indicates that the loader's vacuum motor is operating and the loader should be moving both virgin and regrind materials into the loader, via a ratio valve.

## **VAC OFF: DUMPING**

This status message indicates that the loader's virgin and/or regrind vacuum on-time has expired, the vacuum motor has stopped and the loader should now be dumping material. On Positive Discharge loaders, the valve on the bottom of the loader should be open while this message appears. This message appears only when no blowback pulses are set on the control.

## **DUMP + BLOWBACK**

This status message indicates that the loader's virgin and/or regrind vacuum on-time has expired, the vacuum vacuum motor has stopped and the loader should now be dumping material and the blowback function should be taking place to clean the loader filter with compressed air. On Positive Discharge loaders, the valve on the bottom of the loader should be open while this message appears. This message appears only when any number of blowback pulses are set on the control.

## **LINE PURGING**

This status message indicates that the virgin and/or regrind load times have expired, but the vacuum motor continues to operate while the material purge valve is closed to material flow and open to air flow to clean out the material conveying line.

---

# ALARM MESSAGES

These messages will appear automatically as the alarm conditions that cause them occur. An output signal is created (120 VAC) as these messages occur and the alarm light LED on the control face is illuminated.

|                    |
|--------------------|
| <b>NO MATERIAL</b> |
|--------------------|

alternating with

|                        |
|------------------------|
| <b>FILL SENS UNSAT</b> |
|------------------------|

This alarm message indicates that the virgin and/or regrind load times have expired, but the fill sensor in the body of the loader has not been satisfied. This message will occur with every loading cycle until the load time is increased (to allow material to reach the fill sensor) or the sensor has been adjusted to properly “see” the material being loaded, *see Adjusting Sensors, section 7*.

|                    |
|--------------------|
| <b>NO MATERIAL</b> |
|--------------------|

alternating with

|                        |
|------------------------|
| <b>ADJ FILL SENSOR</b> |
|------------------------|

alternating with

|                      |
|----------------------|
| <b>RESET CONTROL</b> |
|----------------------|

This alarm message indicates that the fill sensor in the body of the loader continues to “see” material after a load and a dump cycle have taken place. This is usually an indication that the fill sensor is out of adjustment (too sensitive) and needs to be adjusted to a less sensitive setting, *see Adjusting Sensors, section 7*. Note that this alarm message halts loader operation until the sensor is adjusted and the control reset by turning it off for three (3) seconds, then back on.

|                    |
|--------------------|
| <b>NO MATERIAL</b> |
|--------------------|

alternating with

|                        |
|------------------------|
| <b>TOO MANY CYCLES</b> |
|------------------------|

This alarm message indicates that the loader has made a number of attempts to load material but has not yet successfully satisfied the demand sensor below the loader. The number of loading attempts may be set by the user, *see Program Messages, section 8, SET ALARM #* and this alarm message only appears after the loader has successfully loaded enough times to satisfy the demand sensor at least once after energizing the control. This function is disabled completely, if the alarm # is set to zero, *see Programming Messages, section 8, SET ALARM #*.

---

# ALARM MESSAGES

(CONTINUED)

**NO MATERIAL**

alternating with

**99 ATTEMPTS**

alternating with

**RESET CONTROL**

This alarm message indicates that the loader has made 99 attempts to load material but has not yet successfully satisfied the demand sensor of the loader. At this point the control is prompting the user to correct the material flow problem and reset the control by turning it off for three (3) seconds, then back on, to allow it another 99 attempts to successfully load material and satisfy the demand sensor. This function is disabled completely, if the alarm # is set to zero, *see Programming Messages, section 8, SET ALARM #.*

**NO LOAD TIME SET**

This alarm message indicates that no load times (virgin or regrind) have been set on the control, therefore the loader cannot operate. Virgin (VIR SECS) and/or regrind (REG SECS) values greater than zero (0) must be set into the control via Security Level B, to eliminate this message and allow the loader to operate.

# PROGRAMMING MESSAGES

These messages will only appear as the control is stepped through programming Security Levels A, B, C or D, as explained below. Each heading is accompanied by its factory-set value.

**Security Level A Messages** (obtained by pressing the function button once)

**VIR SECS → 30**

This message tells the user how many seconds of virgin load time are programmed into the control. No changes are possible at this level, only viewing of the setting. Thirty (30) seconds is the factory set default.

**REG SECS → 0**

This message tells the user how many seconds of regrind load time are programmed into the control. No changes are possible at this level, only viewing of the setting. Zero (0) seconds is the factory set default.

**Security Level B Messages** (obtained by pressing the function button and the “up” arrow button at the same time),

**SET VIR SECS → 30**

This message allows the user to program how many seconds of virgin load time are needed to fill the loader hopper. Thirty (30) seconds is the factory-set default, but this setting may be adjusted higher or lower with the up and down arrow buttons. Full range is 0 to 120 seconds.

**SET REG SECS → 0**

This message allows the user to program how many seconds of regrind load time are needed to supply regrind material. Zero (0) seconds is the factory-set default, but this setting may be adjusted higher or lower with the up and down arrow buttons. Full range is 0 to 120 seconds.

---

# PROGRAMMING MESSAGES

(CONTINUED)

**Security Level C Messages** (obtained by pressing the function button and the “up” arrow button at the same time, and then again pressing the function button and the “up” arrow button at the same time)

## SET BB PULSES → 3

This message allows the user to set the number of blowback pulses that will occur after the vacuum loading function has taken place. Factory default is 3 and the up and down arrows allow the setting to be increased or decreased. Full range is 0 to 7 pulses. Note that increasing the number of pulses may slightly decrease the throughput capabilities of the loader by dedicating more time to filter cleaning.

## SET PURG SECS → 0

This message allows the user to set the purge time in seconds. This value should be changed only if a purge valve is installed on the material line. Factory-set default is 0 and the up and down arrow allow the setting to be increased and decreased accordingly. Full range is 0 to 120 seconds.

## SET ALARM # → 3

This message allows the user to set the number of times the loader will attempt to load unsuccessfully (load without satisfying the demand sensor) before an alarm occurs. Factory-set default is 3 and the up and down arrows allow the setting to be increased and decreased accordingly. Full range is 0 to 99 attempts. Note that this alarm can only occur after the loader has successfully satisfied the demand sensor at least once after energizing the control. This feature keeps the control from creating nuisance alarms while attempting to fill large hoppers or bins for the first time. Once satisfied for the first time, the control will “count” load attempts and alarm if not satisfied within the alarm attempts entered. Note that setting this parameter to “0” disables all demand sensor alarms, *see Alarm Messages, section 8-3*, for more information.

---

**SET OFF SECS → 8**

This message allows the user to set the length of time that the loader will not operate between loading cycles or the “vacuum off-time”. This setting is useful for assuring that the loaded material has enough time to gravity dump from the loader through the discharge valve. An output signal is provided as this function is energized. On Positive Discharge loaders, this setting determines how long the discharge valve is opened at the end of a loading cycle. Factory-set default is eight (8) seconds and the up and down arrow allow the setting to be increased and decreased accordingly. Full range is 4 to 999 seconds. The upper end of these settings may be used to operate a loader only periodically instead of on-demand. A popular application is for a loader that is used to keep a granulator empty by offloading the regrind into a bin. The off-seconds may be set very high so that the loader only operates every 10 minutes (600 seconds) instead of constantly.

**SET LAYERS # → D**

This message allows the user to set the number of layers desired when loading both virgin and regrind materials. This function only occurs when there are seconds entered into both virgin and regrind functions. This setting then determines how many times during a single loading sequence that the ratio valve will switch between virgin and regrind to encourage layering of the materials in the loader, so the material will mix when dumped into the receiving hopper below the loader. The flow characteristics of the virgin versus regrind, the differences in material line lengths, and the differences in load times must all be considered before deciding on the proper number of layers for each loading application. To make these choices easier, a factory-set default setting (“D”), based on the amount of regrind time that has been entered, is included in the possible setting range. Its use is encouraged to prevent confusion, at least until a specific need for alternate layers settings is defined for your application. In addition to D, a 1 to 5 setting range is provided, and any of these settings will over-ride the default.

## PROGRAMMING MESSAGES

(CONTINUED)

**NOTE:** For unloading applications (where the loader is used to off load a device, like a granulator, instead of “loading” a device, like a machine hopper) the “SET ALARM #” should be set to zero. This will defeat alarm conditions that can be created because the loader may never be ‘satisfied’ by filling the vessel it is installed above. **See: “Programming Messages”...” SET ALARM #”.**

---

# SPECIAL PROGRAMMING FUNCTIONS

**NOTE:** *DustBeater controls are commonly re-programmed by Conair to accommodate factory supplied options and special functions at the time of order. Returning to factory-default settings will ignore these changes and return the control to its most basic operational mode, as shown in “Programming Messages”.*

## Special Programming Functions

Returning To Factory Defaults:

In the event of confusion with your DustBeater control, as the result of unauthorized programming, the addition or removal of optional features, etc., it may be desirable to return your control to its original factory default settings. These settings are listed in the section titled “Programming Messages” and are shown adjacent to each category described.

To return the control to factory default settings, use the on/off switch to turn off the control, wait three (3) seconds and while holding the “up” arrow button, turn the control back on. All factory default settings will be in place as listed in the “Programming Messages” section of this manual and further changes (ie: the use of a fill sensor, ratio times, etc) may be re-entered as needed.

## Security Level “D”:

### SET LOAD+HOLD OFF

This special function is selectable to allow specially-equipped, positive discharge loaders to be used in applications where material is held within the loader after it is loaded until needed by the process, below the loader. In this application, the demand input (a closure of the demand input terminals) is sent to the control by outboard equipment and is the signal the loader looks for to dump the material from the loader. The loader automatically re-loads material after dumping, without the need for a traditional demand signal from below the loader. This function is useful for loss-in-weight blending systems, where the loader must provide an instant load of material to weight-sensitive supply hoppers below the loader, specifically when needed by the blender. The function may be turned on or off but is factory-set to off. Users should never turn this function on unless the loader and control are specifically outfitted or modified for this function.

When Load and Hold function is employed, the following jumper changes need to be made inside the control, *see Use of Non-Standard Input Devices, section 9, for detailed information on jumpers.*

1. A jumper needs to be installed on the top, #1, jumper position (Demand A).
2. The bottom jumper, #5, needs to be removed.

### NO FILL SENSOR

This feature changes the control’s operation to terminate loading with the use of a fill sensor, installed in the loader body. It also provides alarm functions, minimizes load time and other benefits. To be employed, a proper sensor must be installed in the loader body and connected to the terminal box, the proper jumper arrangement needs to be made inside the control and the feature needs to be turned on. It is usually factory-set to NO FILL SENSOR (unless a fill sensor was originally installed) but may be easily changed to FILL SENSOR USED, using the up or down arrows. Typically, the jumper settings inside the control are already made to accept the common sensors used by Conair for this function, so the only change necessary is to turn this function on to the FILL SENSOR USED display on the control. If the installed sensor does not work properly and is suspected to be a model not specifically selected by Conair for use with this loader and control, then the jumpers inside the control may also need to be changed, *see Input Jumper Settings, section 9.*

## CHANGING OPERATIONAL FUNCTIONS

 **CAUTION:** *These functions should be manipulated with caution since they can alter the entire operation of the control. Some functions must be entered in coordination with jumper settings inside the control, as described below. All special functions are entered by accessing Security Level D, obtained by pressing the function button and the “down” arrow button at the same time and holding for 5 seconds.*

---

# CHANGING OPERATIONAL FUNCTIONS

(CONTINUED)

## MOTOR LOADER

This feature changes the control to operate in a self-contained (motor loader) mode or in a central vacuum, series wired loader mode (Selectronic 6). Users should never change this setting. It is factory-set to MOTOR LOADER and should be left unmodified.

## HIGH CONTRAST

This selection allows the control's text window to be optimally viewed in high contrast from a straight-on viewing angle versus a lower, low contrast viewing angle. It is factory set to HIGH CONTRAST.

---

# JUMPER SETTINGS/ TERMINAL BOX CHANGES

- *Use of Standard  
Input Devices . . . . .9-2*
- *Use of Non-Standard  
Input Devices . . . . .9-3*
- *Changing Input  
Device Jumpers . . . . .9-4*
- *Universal Terminal Box  
(UTB) . . . . .9-5*

---

# JUMPER SETTINGS

**NOTE:** Normal operation with factory supplied sensors or switches does not usually require any changes to jumper settings, since the jumper settings are established at the factory. Faults associated with sensor inputs should first be examined for other, more obvious flaws, before incorrect jumper settings are considered.

Your DustBeater control box operates by receiving input signals from switches, buttons and sensors, then responds with timed outputs to valves, etc. In order to operate correctly, the control must be set up to properly interpret the input signals of specific input sensors and switches, considering source/sink operation, normally open/normally closed, etc. The control is set-up by the placement of small printed circuit board jumpers within the control, directly behind the control face.

## Use of Standard Input Devices

In general, your DustBeater control is configured to operate, as standard, with input devices that work in the following manner:

**Demand Input:** The input device (sensor, paddle, reed switch, etc) should provide a signal closure when the loader requires material. This is commonly expressed as the demand input device providing a "Close on Demand" signal. This logically means that the input device is "open", when the loader is 'satisfied' or does not need material. For capacitive sensors, the form that the sensor takes should be "sink".

**Volume Fill Input:** The input device (sensor, paddle, etc) should provide a signal closure when the loader becomes filled with material during loading. This is commonly expressed as the fill input device providing a "Close on Fill" signal. This logically means that the input device is "open", while the loader is filling or is at rest. For capacitive sensors, the form that the sensor takes should be "sink".

With input devices configured as described above, no technical changes are required with the controls. "Demand" inputs matching the description above should be readily accepted by the control. "Fill" inputs matching the description above may be easily programmed by the user by a simple programming change in the Security D level, identified as NO FILL SENSOR USED, which may be easily changed to FILL SENSOR USED, *see Changing Operational Functions, section 8.*

---

## USE OF NON-STANDARD INPUT DEVICES

If input devices, other than those described above as "Standard Input Devices" are intended to be used with your Conair DustBeater, changes are required in the control to allow the control to 'read' these devices and respond appropriately.

A series of jumpers are provided inside the control that adjust the control's operating parameters to allow use of non-standard devices like Demand inputs that "open on demand", or are "source" form, or Fill sensors that are "source" form.

Instances where these changes might be needed are with the use of special input devices for special applications, use of a Conair DustBeater controls on competitive equipment and in some cases the use of newer DustBeater controls on older generations of Conair loaders.

To change the input operating parameters for your DustBeater controls, you will need to know the specifications of the input device you wish to employ:

**For Demand Input Devices:**

- Close on Demand (Standard) or Open on Demand (non-Standard)
- Sink Form (Standard) or Source Form (non-Standard)

**For Fill Input Devices:**

- Sink Form (Standard) or Source Form (non-Standard)

Once the specifications are known, doublecheck that the "Use of Standard Input Devices" operation (above) does not already accommodate your input device. If it does not, the internal jumpers may be changed to accommodate your non-standard input device.

# CHANGING INPUT DEVICE JUMPERS

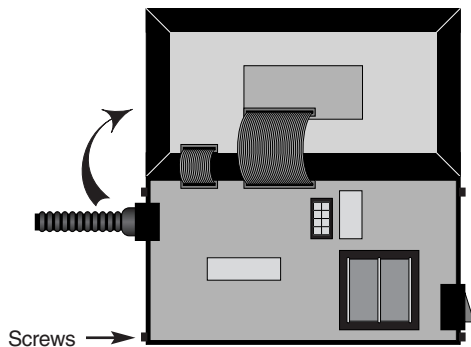

To change the jumpers, first disconnect power to the control by disconnecting the line cord from the power outlet. The control's backlit window should be dark, regardless of the position of the on/off/reset switch. The control does not need to be removed from its installed position, unless there is an obstruction directly above its enclosure.

Refer to illustration at left to carefully remove the four screws that hold the front face to the control box, gently swing the front face up and place it on top of the control enclosure, exposing the insides of the control and the backside of the control face. Be careful not to put any strain on the ribbon cables that connect the front face with the control box.

Note the location of the jumper block labeled as "CN6" within the control, adjacent to a wiring harness connector and behind the wires leading to that connector. The connector may be removed for ease of studying the jumper settings and/or making changes by gently prying between the right side of the connector and its holder with a flat bladed screwdriver. The connector may then be drawn straight out of its socket and moved aside, to allow full visibility of the jumper settings. Take care to not separate the wires from the connector.

The CN6 jumper block contains 5 jumper positions, each consisting of a pair of pins. Some of the pin pairs are connected with small jumper modules. Starting at the top position, #1 and #2 correspond to Demand sensor or switch conditions and are referred to as "Demand A" (#1) and "Demand B" (#2). The next two positions are "Fill A" (#3) and "Fill B" (#4) and correspond to Fill sensor or switch conditions. The bottom position (#5) is a "Logic Jumper" for demand inputs.

The following chart shows the required jumper connections that need to be made for alternate (non-standard) input devices.

|  |  |
|--|--|
| <p><b>Input Demand Device</b> (non-standard)<br/>"Open on Demand" operation</p>                    | <p><b>Jumper Change</b><br/>Remove jumper #5 (demand logic)</p>                                    |
| <p><b>Input Sensor Form</b> (non-standard)<br/>Sourcing Demand Sensor<br/>Sourcing Fill Sensor</p> | <p>Move jumper from #1 position to #2 position<br/>Move jumper from #3 position to #4 position</p> |

---

# UNIVERSAL TERMINAL BOX (UTB)

Your DustBeater is provided with a junction box that provides receptacles for all input and output devices and provides a connection point for the umbilical cable that connects the control to the loader. This box will accommodate all current and future options for your DustBeater and is commonly referred to as a Universal Terminal Box or “UTB”.

The UTB is provided with the most common outputs available for use on the outside of the box. In the event that you add options to your loader and the appropriate output connection cannot be found on the UTB, changes may be made inside the UTB to accommodate your new option. A full explanation is also printed inside the lid of the UTB, for your convenience.

The cover of the UTB may be removed to make all terminations available for change.

1. Remove all power from the loader and/or motor of the DustBeater by disconnecting the power cord and performing lock out/tag out procedures according to your company policies and safety codes.
2. Remove the loader control box from the UTB by the method detailed in **“Control Installation-Remote Control,” section 4.**
3. Remove the front cover of the UTB by turning the screw head in the middle/bottom of the front cover counter-clockwise to unlock the cover, then use the small indentation below the screw to reach below the cover and work it away from the UTB.
4. Notice the instructions on the back side of the UTB cover, for future reference.

Output signals that are currently connected to the receptacles on the outside of the UTB are joined together at the vertically mounted terminal strip near the right side of the box. The color coded outputs are as follows:

|                  |  |
|------------------|--|
| Black .....      | Load   |
| Brown. ....      | Ratio Valve  |
| Red/yellow. .... | Positive Discharge<br>(air operated discharge valve) |
| Red/blue.....    | Purge Valve  |
| Blue.....        | Blowback   |
| Violet .....     | Alarm Output   |

---

# UNIVERSAL TERMINAL BOX (UTB) (CONTINUED)

Four receptacles are provided on the outside of the UTB and they may be used as needed to provide a connection point for output devices. Unused, color-coded output conductors are insulated and tucked inside the UTB so that if an alternate output is required, they may take the place of an unnecessary output position by wiring it to the terminal strip. Unused output wires should be insulated (taped) against potential short circuits and tucked back inside the UTB.

Output receptacles that are re-assigned a new output function, should be labeled according to their new function, for future reference. Labels for standard output assignments are permanently printed to the side plate of the UTB and removing them should not be attempted. Instead, labels are contained on the backside of the UTB cover plate that may be separated from the main label and placed over the original labels on the sideplates.

# MAINTENANCE

- *Conveying Filter Cleaning* .. 10-2
- *Compressed Air Filter Cleaning* .....10-3
- *Motor Brush Checking/ Replacement* .....10-4

---

# CONVEYING FILTER CLEANING

 **CAUTION:** *Be sure to wear safety glasses to guard against air-borne material particles if compressed air cleaning is employed. Be sure that the compressed air being employed is completely dry and will not add moisture to the filter media. If moisture is added, the collected fines will probably solidify into clumps that will be very difficult to remove. If moisture is accidentally introduced, set the filter aside and allow it to thoroughly air dry before vacuuming at a later time, or replace it with a new filter.*

The filter of your Dustbeater Loader is designed to protect the motor from damage by plastic pellets, regrinds, and fines that are drawn to the loader by the vacuum action of the motor. The filter, situated between the vacuum hopper and the lid of the loader, separates vacuum conveying air from the loaded material and can become caked with material dust as material is loaded. The blowback function (if your Dustbeater is equipped with it), which takes place at the conclusion of each loading cycle, does a good job of cleaning the filter, but occasionally the filter will need manual cleaning, or eventual replacement, to stay effective. The schedule of cleaning will depend upon how much material and how clean the material being conveyed is (dusty regrind causes rapid filter blinding).

To remove the filter, first disconnect power to the loader. The filter may be exposed by lifting the lid of the loader. Once the lid is released, the filter may be removed. Clean the filter with either compressed air, blowing against the motor (“This Side Up”) side, or with a vacuum cleaner sucking against the bottom, fabric side of the filter.

Be sure to discard and replace any filter that has developed a hole, or has become hopelessly clogged with material dust. Do not attempt to repair a damaged filter.

The filter in a Conair Loader performs double duty as an effective seal between the hopper body and the lid of the loader, so be sure to examine the integrity of the rubber perimeter to be sure that the loader will seal effectively when the filter is reinstalled into the loader.

The filter may be reinstalled by placing it carefully on top of the loader body’s top flange, and positioning the lid down around it. The filter is labeled “This Side Up,” indicating the side to be installed toward the vacuum motor lid. The cloth filter media should be installed down, where it will come in contact with the loaded material. Be sure to keep from crushing the filter or filter seal with the lid, in the event the filter is reinstalled off-center. The loader lid is secured with the twist lock clamps. Reconnect compressed air hose and the vacuum motor power cord.

---

The compressed air connection of the loader is provided with a moisture trap to prevent troublesome moisture, contained in the air supply, from entering the loader. The filter bowl of this moisture trap must be emptied regularly to drain the water from the air system. Follow the instructions listed on the filter bowl itself, which usually requires opening a port at the base of the bowl and letting the water in the bowl blow out in a stream of compressed air. A path for this blowout of moisture is usually a good idea, to prevent a stream of moisture laden air from contaminating machines or people. It is also a good idea to inspect the bowl periodically with the compressed air supply turned off, to clean or replace the filter element if need be to remove contaminant accumulation.

## **COMPRESSED AIR FILTER CLEANING**

---

# MOTOR BRUSH CHECKING/ REPLACEMENT

**NOTE:** “Brushless” motors require no brush checking or replacement.

The vacuum motors employed on Self-Contained Material Loaders are powered by brush type, high RPM motors that require maintenance to the brushes on a regular basis. The brushes should be checked to prevent complete brush wear down, which could be damaging to the motor armature and the brushes should be replaced if they are extensively worn.

Access to the brush area differs on the two models of Dustbeater Loaders covered in this manual.

## **To access the brush on the DB12 Loaders (7/8 Hp Motor with 4 brushes):**

The brushes on the DB12 are contained within two circular caps visible on each side of the uppermost section of the motor. Disconnect power and remove the acorn nuts that secure the circular caps to the motor body. Inside each cap are two spring mechanisms that secure the brushes, under tension, against the motor armature. The brushes may be removed by prying off the spring clips. Examine the brushes carefully to be sure that the brush is still intact and not disintegrated from use. The brush should be at least 1/2 inch long to be returned to service. If any brush is not, replace all four immediately.

## **To access the brush on the DB8 Loaders (5/8 Hp Motor with 2 brushes):**

The brushes of a DB8 loader are located within a protective guard that covers the top of the motor. The guard may be removed but use caution when removing the guard since the motor’s power cord runs through the guard and will still be connected to both the guard and motor when the guard is removed. Once the guard has been removed, the motor brushes will be visible on each side of the motor, held in place with two slot headed screws. The brushes and their holders may be freed by removing the screws. Examine the brushes carefully to be sure that the brush is still intact and not disintegrated from use.

The brush should be at least 1/4 inch long (as measured from the motor end to the brush holder) to be returned to service. If either brush is not, discard the brushes and holders and replace both immediately.

# TROUBLESHOOTING

- *Conveying problems  
and solutions . . . . . 11-2*
- *Control problems  
and solutions . . . . .11-4*

## CONVEYING PROBLEMS

**⚠ WARNING: Disconnect power and air sources.** Always disconnect the pump from the loading control, main power source and compressed air source before removing the dust collection canister. This prevents the pump from starting during servicing, which could cause personal injury from flying debris or moving parts.

| Problem                  | Possible cause   | Solution   |
|--------------------------|--|--|
| Low or no material flow. | Does the filter need to be cleaned?                                    | Check the filter to see if it is clogged with dust or fines. If the filter is clogged, clean it. See <b>CLEANING THE FILTER..</b>  |
|                          | Is there an overload on the circuit breaker(s)?                        | Reset the circuit breaker if it is tripped. Check for the cause.   |
|                          | Are there kinks in the flex hose?                                      | Check the vacuum and material flex hose lines for loops and “S” curves. Remove any loops and “S” curves in the flex hoses. Try to keep the hose as straight as possible. |
|                          | Are there holes or cracks in any of the material lines?                | Check the material line for holes, cracks or other signs or excessive wear. Replace worn flex hose.  |
|                          | Are hose connections too loose?  | Check vacuum and material line hose connections for leaks. Hose clamps should be secured near the end of the hose connections.   |
|                          | Are material to air adjustments at the material pickup device correct? | Check the material to air adjustments at the feed tube or distribution box to make sure they are properly adjusted. <b>(SEE SECTION 6).</b>                              |
|                          | Do you have enough material at the source?                             | Replace/refill the material container or reposition the feed tube.   |
|                          | Are the motor brushes worn?  | Check the motor brushes. If any brush is too short, replace all brushes <b>(SEE SECTION 10).</b>   |

**⚠ WARNING: Disconnect power and air sources.** Always disconnect the pump from the loading control, main power source and compressed air source before removing the dust collection canister. This prevents the pump from starting during servicing, which could cause personal injury from flying debris or moving parts.

## CONVEYING PROBLEMS

| Problem   | Possible cause   | Solution   |
|---|--|--|
| Low or no material flow (continued).  | Has material plugged the tubing or flexible hose?  | Remove the conveying line from the material and check vacuum. If necessary, uncouple the lines, remove blockages and reassemble the lines. Readjust for proper material flow ( <i>SEE SECTION 6</i> ).   |
| Motor speed sounds like it varies as it operates (brushless motor option only). | 120 volt input power is below standard. Motor is attempting to automatically compensate. | Correct power supply or switch power receptacle that loader is connected to.   |
| Motor speed sounds like it varies as it operates.                               | Motor brushes are used up. Increased arcing is creating uneven motor speeds.             | Check and/or replace brushes ( <i>SEE SECTION 10</i> ).  |
|   | Are sensor(s) adjusted properly?   | Make sure the demand sensor is set a proper distance from the glass, and is positioned at the level of material you want to maintain.  |
|   | Is there a vacuum air leak?  | <p>Check o-rings and gaskets for damage or leaks.</p> <p>Check the (optional) volume fill sensor, for a tight seal.</p> <p>If the blowback option is installed, make sure the compressed air line is connected at the lid.</p> <p><b>For Direct Feed Models</b><br/>Check the mounting gasket and plate for a tight seal. If the mounting is not sealed 100%, you may need an isolator valve to maintain vacuum.</p> |

# CONTROL PROBLEMS

**⚠ WARNING: Disconnect power and air sources.** Always disconnect the pump from the loading control, main power source and compressed air source before removing the dust collection canister. This prevents the pump from starting during servicing, which could cause personal injury from flying debris or moving parts.

| Problem   | Possible cause  | Solution  |
|---|---|---|
| Loader will not cycle.  | Are all electrical connections correct?   | <p>Check to make sure the loader control is plugged into a power source.</p> <p>Check to make sure the UTB is connected to the loader control.</p> <p>Check to make sure the sensor(s) is connected to the UTB.</p> |
| Loader does not respond. Sensors do not respond.  | Shorted output device. Wrong voltage applied to unit. Internal Fuse #F1 is open.                          | Replace fuse #F1.   |
| No back light on control face.  | If unit was opened for any reason, possible misalignment of internal connectors opened internal Fuse #F2. | <p>Examine connections inside. Correct connections.</p> <p>Replace fuse #F2.</p>  |
| Sensors do not respond, but control illuminates.  | Sensor(s) incorrectly wired. Internal Fuse #F3 opened.  | <p>Correct sensor wiring.</p> <p>Replace fuse #F3.</p>  |
| <p><b>Fuse descriptions:</b><br/> <b>F1</b>=3.15 Amp, 8mm Round, inside control<br/> <b>F2</b> and <b>F3</b>=0.5 Amp, 8mm Round, inside control</p> |   |   |

---