

Parts Identification Guide
PIP005/0406

Water Slide Pelletizer 200 Series

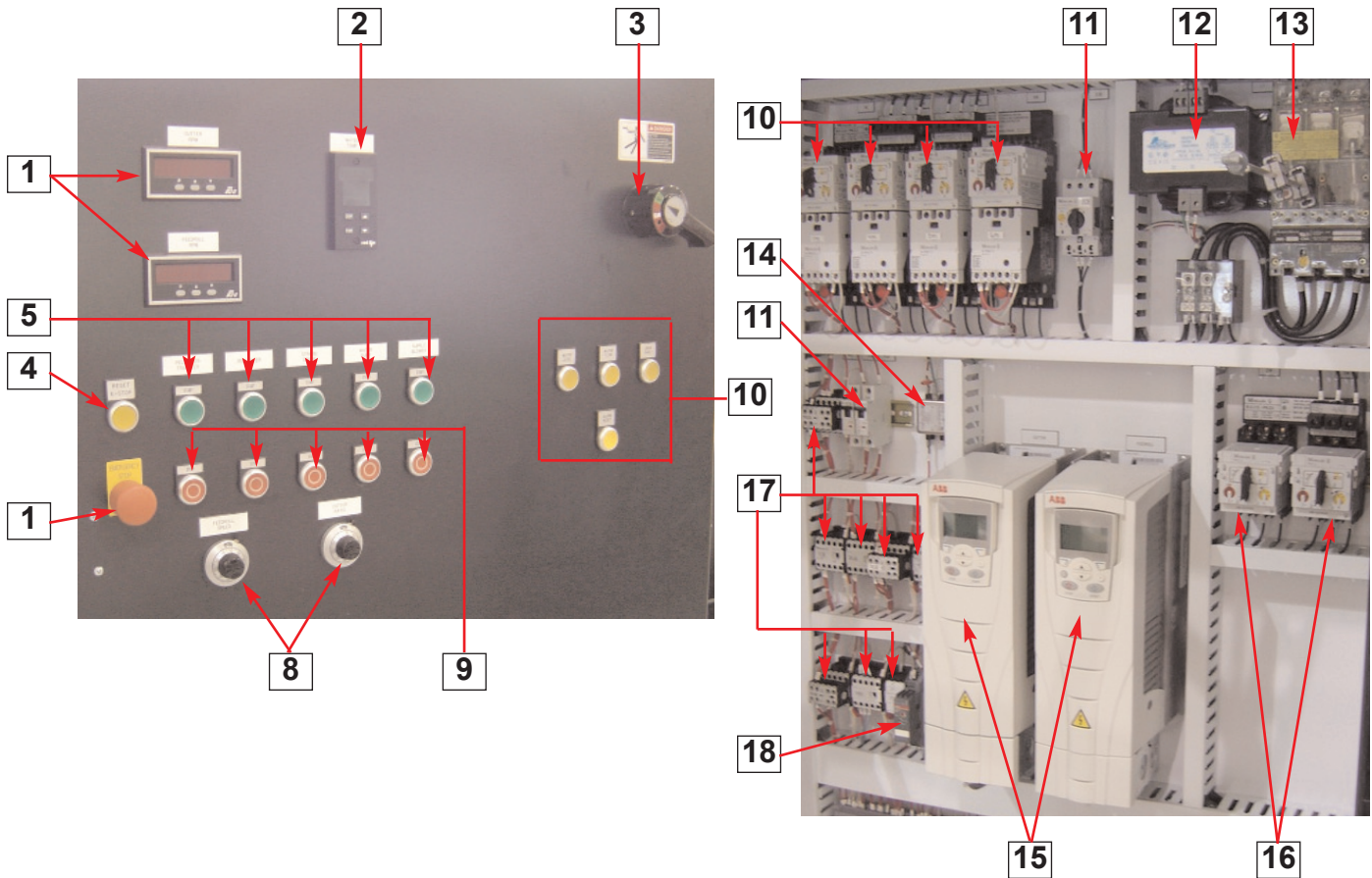



Water Slide Pelletizer 200 Series

1. Digital Readouts
2. Temp. Controller
3. Disconnect Handle
4. Reset Button
5. Start Buttons
6. Manual Buttons
7. Emergency Stop Button
8. Potentiometers
9. Stop Buttons
10. Starters
11. Breaker(s)
12. Transformer
13. Disconnect Switch
14. Filter
15. Controls
16. Motor Overloads
17. Relays
18. Signal Isolator

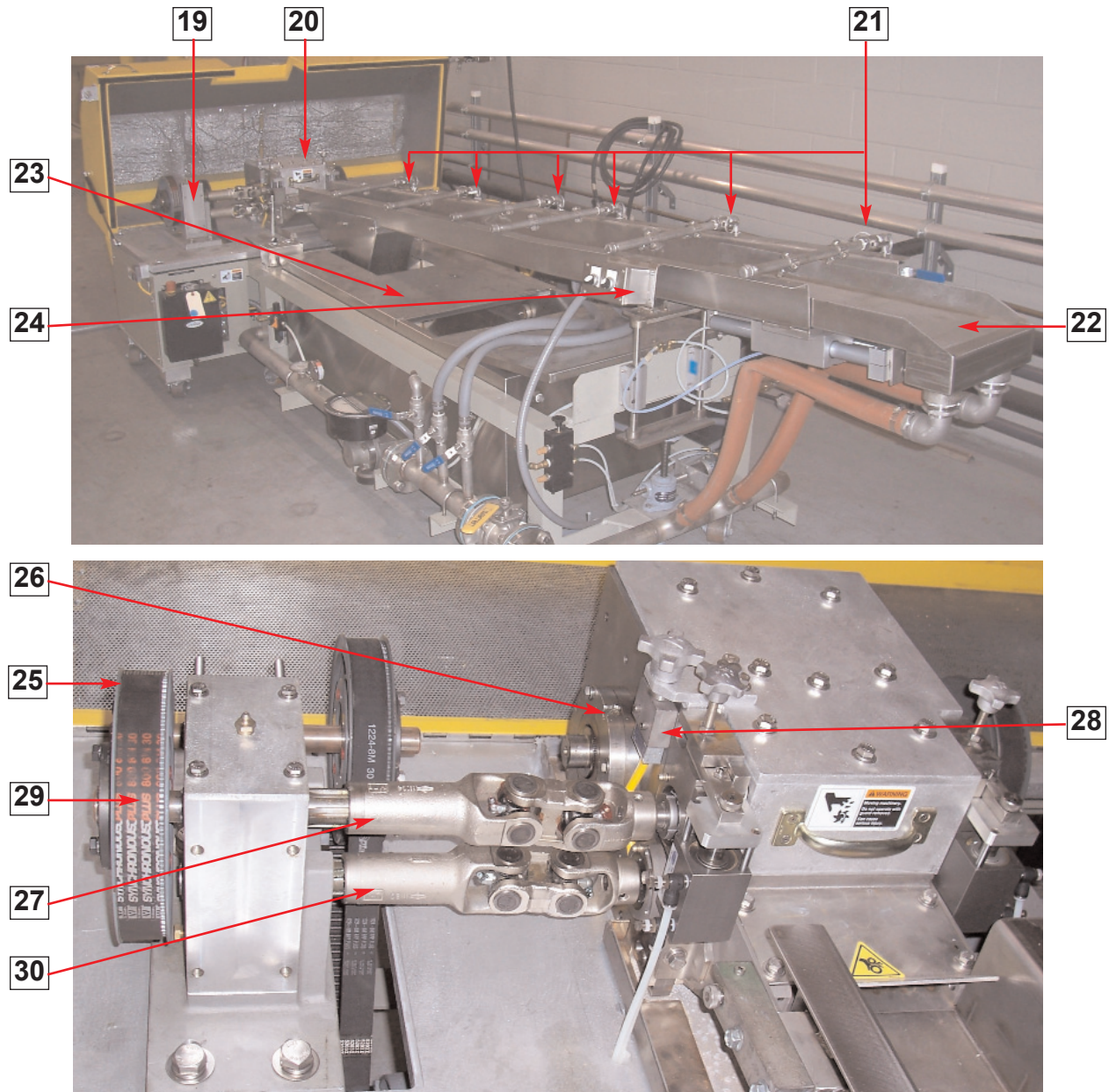

**Water Slide Pelletizer
200 Series**

- 19. Gear Box Assembly
- 20. Pelletizing Cutting Chamber
- 21. Spray Bar Assembly
- 22. Sluice Tray
- 23. Sump Tank
- 24. Sluice Tray and Feed Roll Control Box

- 25. Gear Box Driven Pulley
- 26. Rotor Eccentric
- 27. UFR U-Joint
- 28. Rotor Cover Safety Switch
- 29. Gear Box Driven Belt
- 30. LFR U-Joint

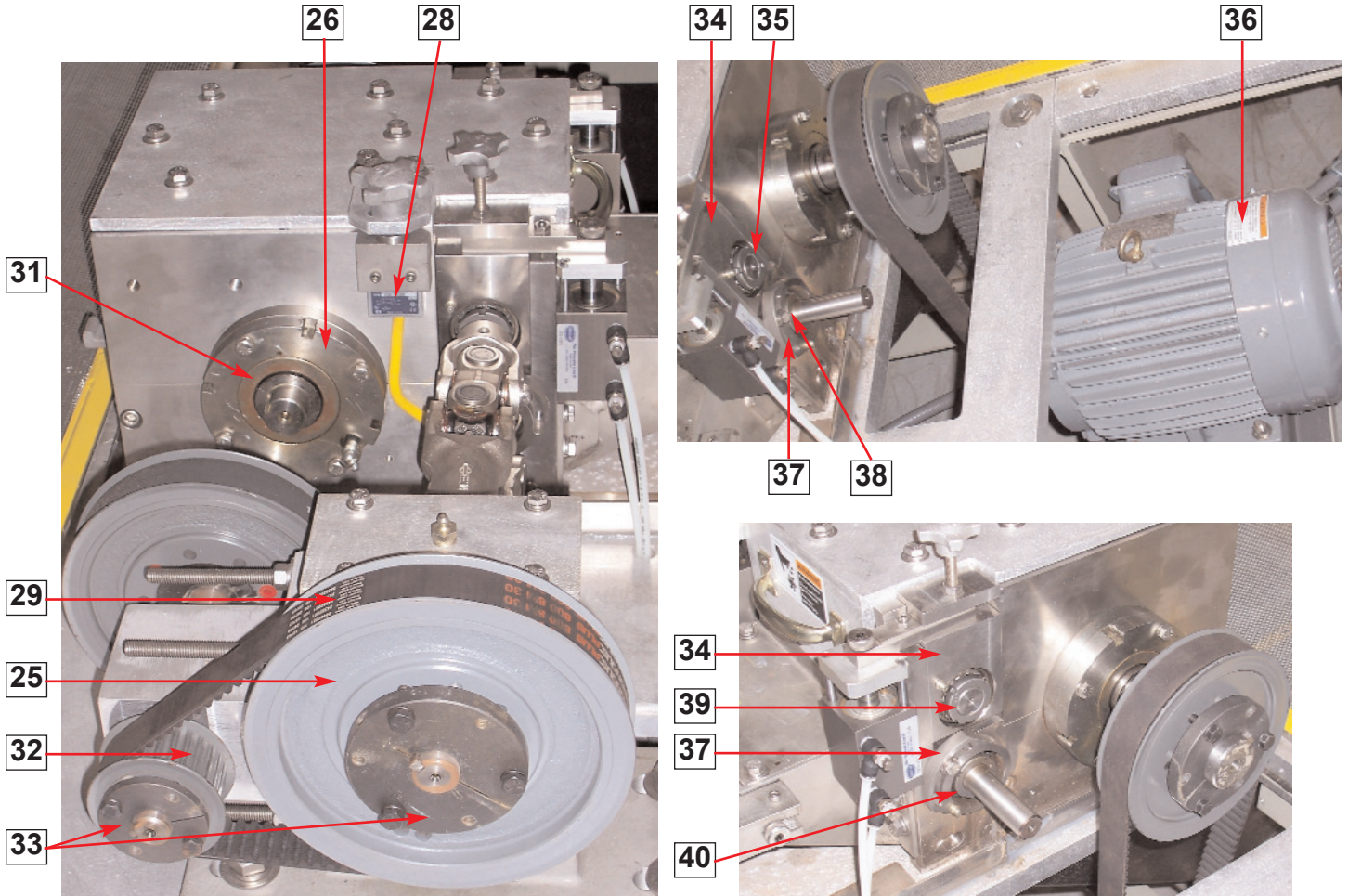

**Water Slide Pelletizer
200 Series**

- 25. Gear Box Driven Pulley
- 26. Rotor Eccentric
- 28. Rotor Cover Safety Switch
- 29. Gear Box Driven Belt
- 31. Rotor Bearing
- 32. Idler Shaft Drive Pulley
- 33. Bushing
- 34. UFR Bearing Block
- 35. UFR Bearing
- 36. Rotor Motor
- 37. LFR Eccentric
- 38. LFR Bearing
- 39. UFR Lock Nut and Washer
- 40. LFR Lock Nut and Washer

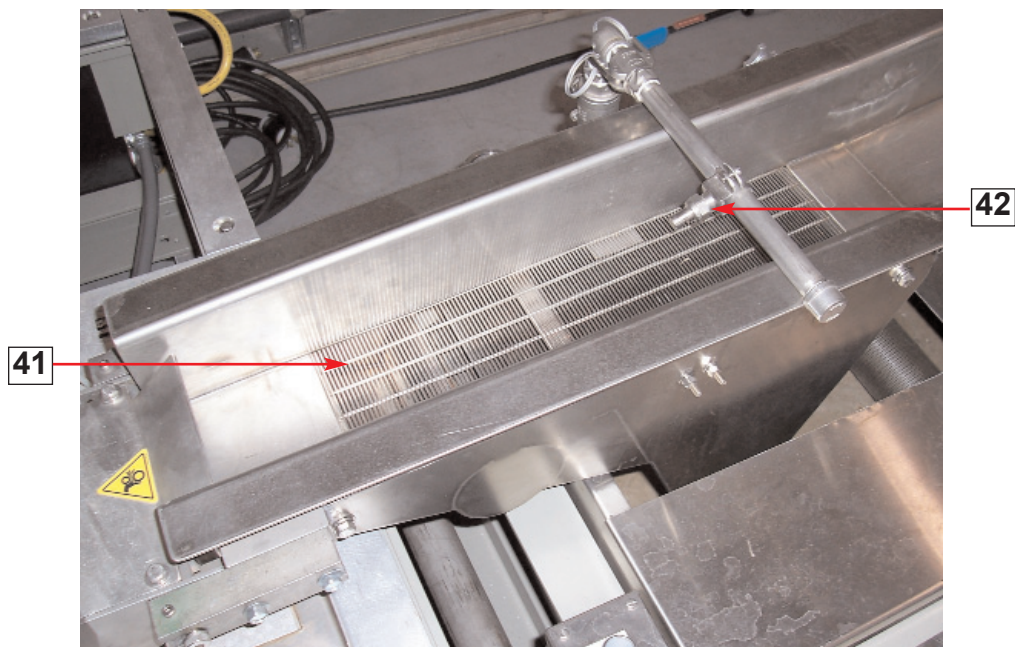
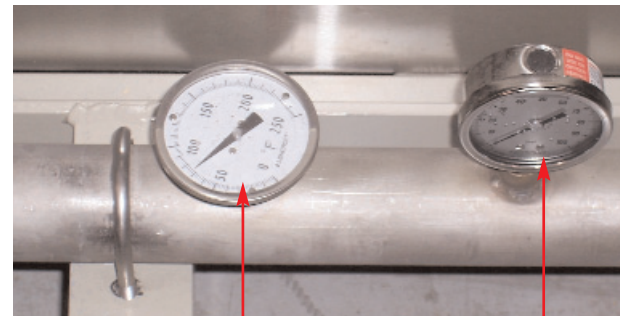
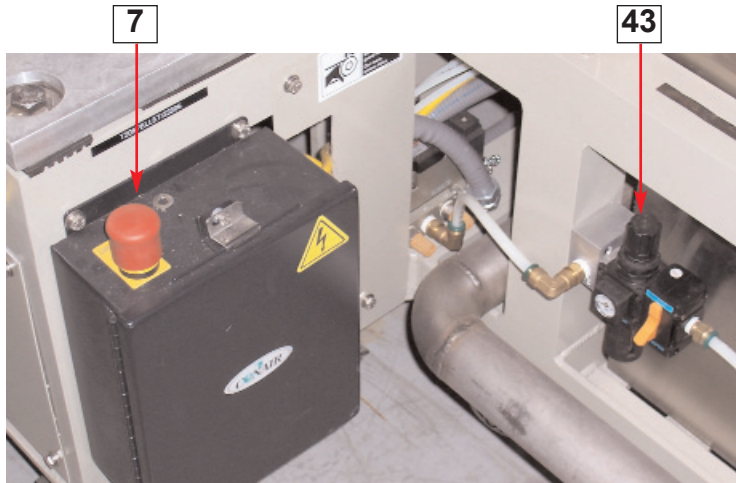

Water Slide Pelletizer 200 Series

- 7. Emergency Stop Button
- 41. Water Drop Out
- 42. Spray Nozzle
- 43. Air Regulator
- 44. Temperature Gauge
- 45. Pressure Gauge

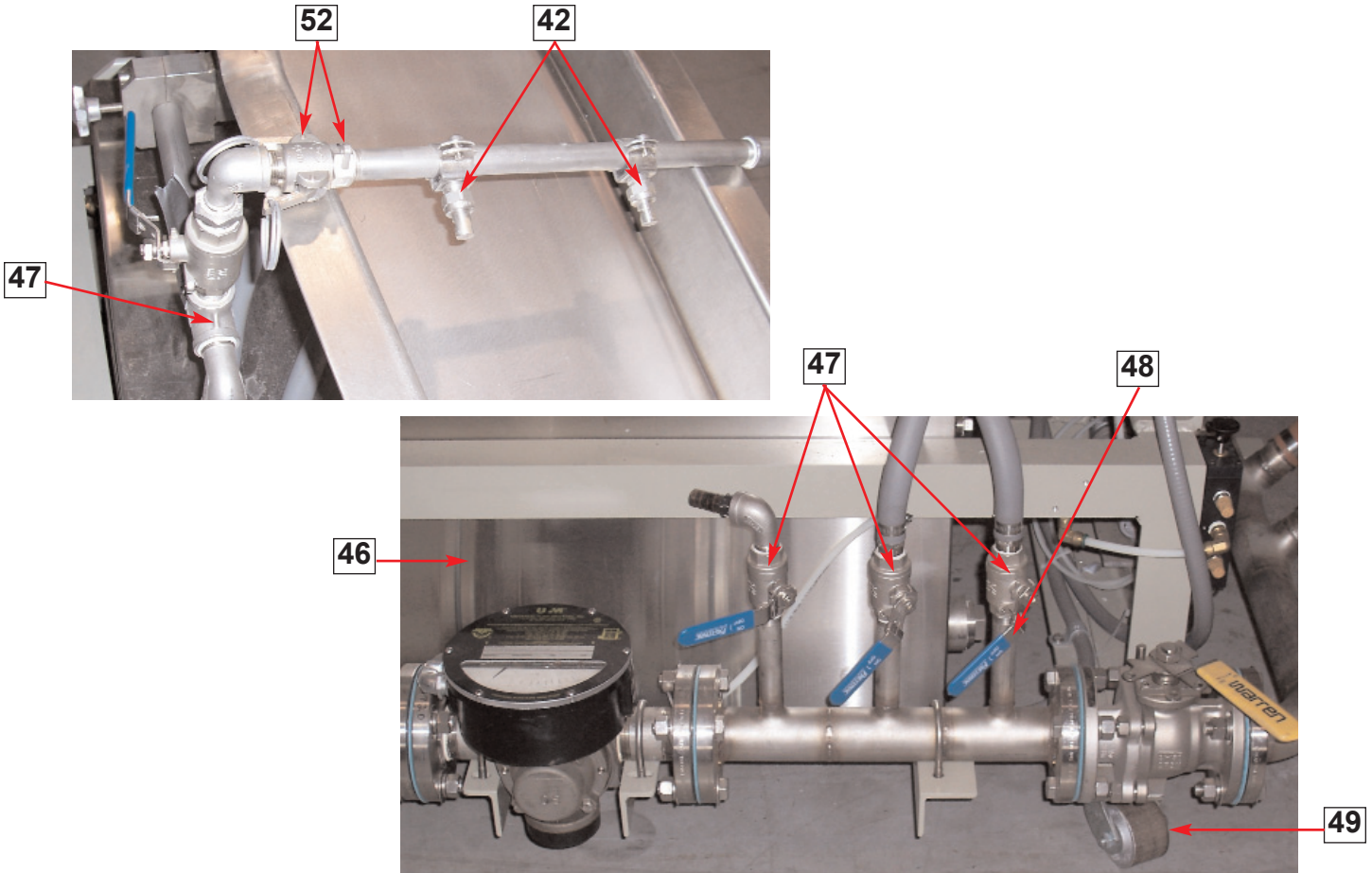

Water Slide Pelletizer 200 Series

- 42. Spray Nozzles
- 46. UFM Flow Monitor
- 47. 3/4" Ball Valves
- 48. Shut Off Valve
- 49. Swivel Casters
- 52. Kwik Cam-Locks

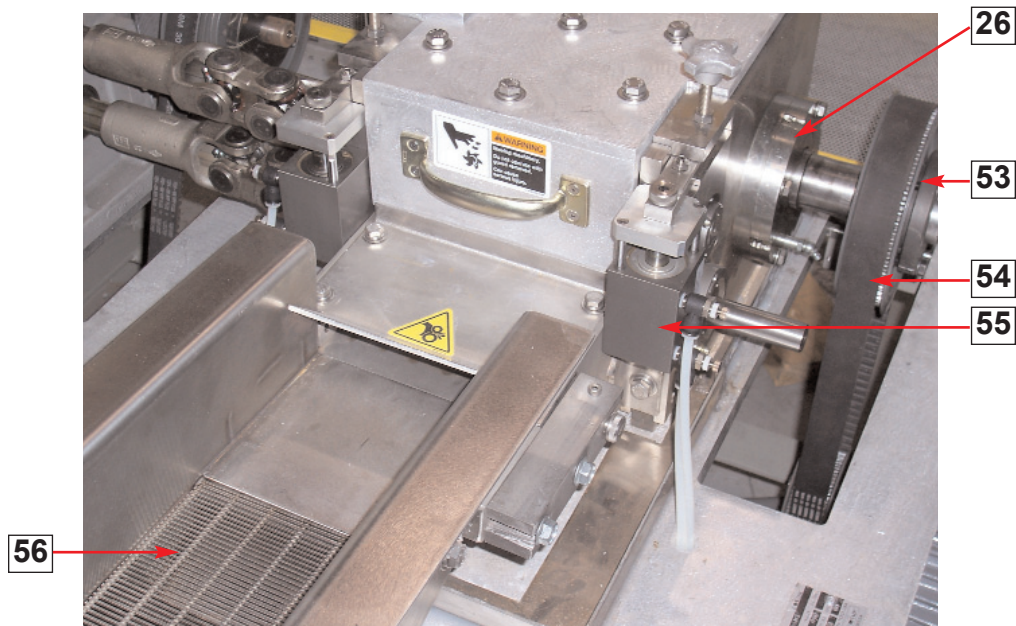
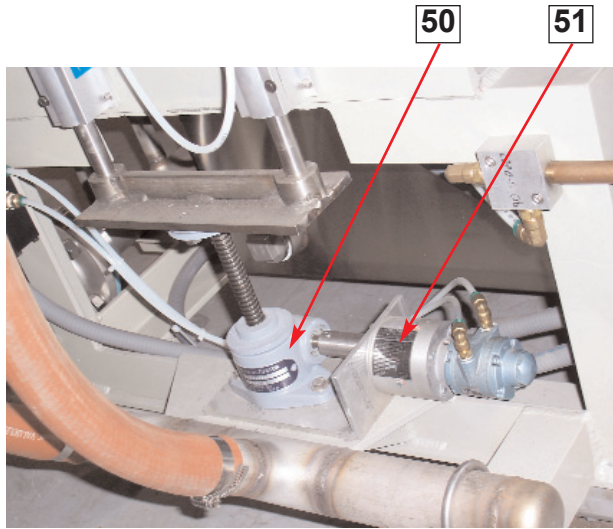

Water Slide Pelletizer 200 Series

- 26. Rotor Eccentric
- 50. Actuator - Screw
- 51. Gear Motor
- 53. Rotor Driven Pulley
- 54. Rotor Drive Belt
- 55. UFR Air Cylinders
- 56. Water Separator
- 57. Filter Strainer

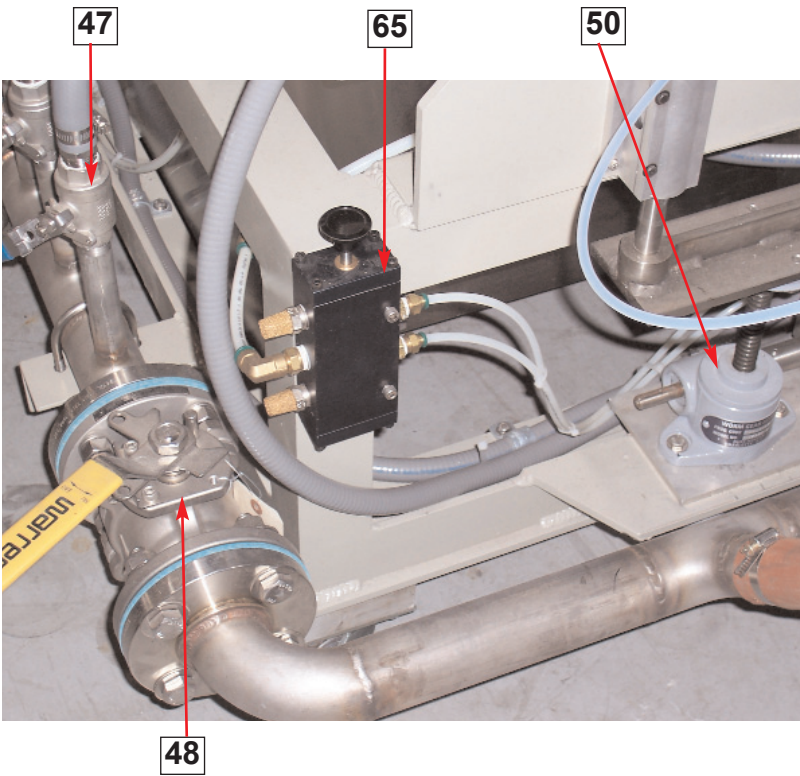
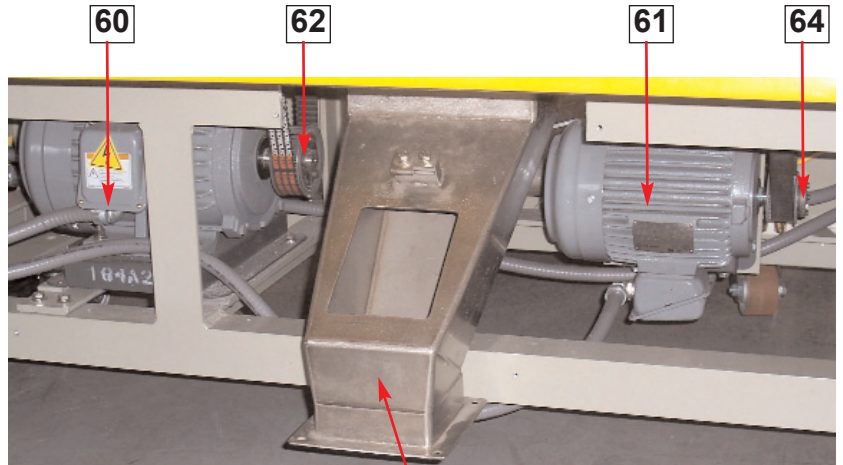
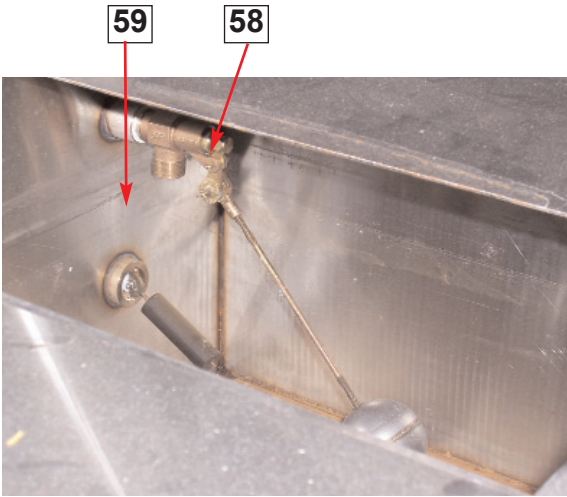

**Water Slide Pelletizer
200 Series**

- 47. 3/4" Ball Valve
- 48. Shut Off Valve
- 50. Actuator Screw
- 58. 3/4" Float Assembly
- 59. Electronic Float
- 60. Rotor Drive Motor
- 61. Gear Box Drive Motor
- 62. Rotor Drive Pulley
- 63. Discharge Chute
- 64. Gear Box Drive Pulley
- 65. Push - Pull Valve

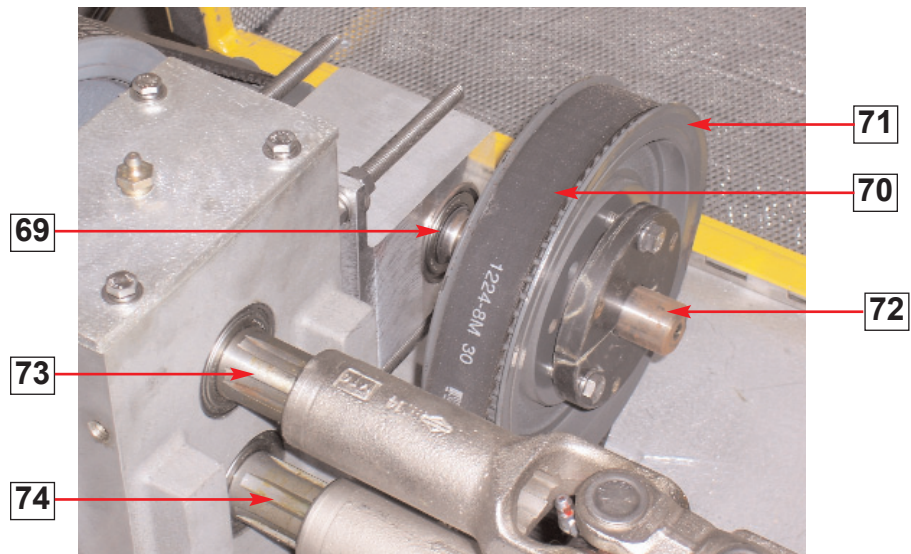
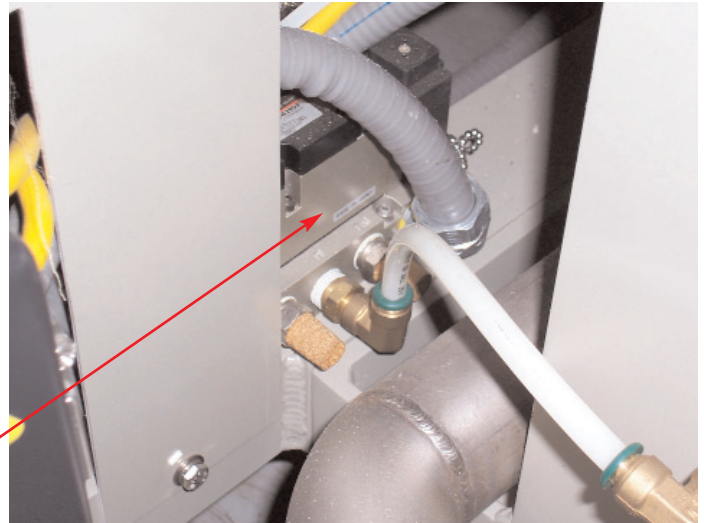
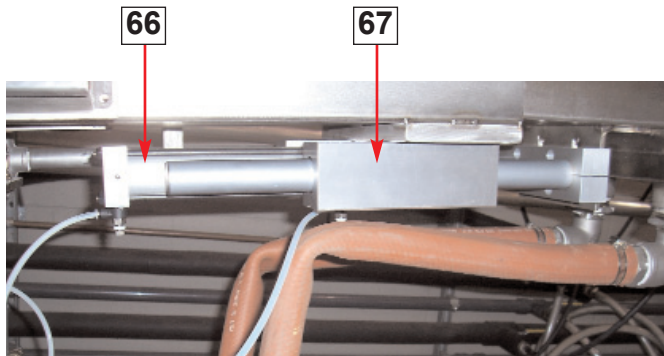

Water Slide Pelletizer 200 Series

- 66. Cylinder for Sluice Tray
- 67. Movement for Sluice Tray
- 68. Solenoid Valve Assembly
- 69. Idler Bearing
- 70. Idler Drive Belt
- 71. Idler Shaft Input Pulley
- 72. Idler Shaft
- 73. UFR Drive Shaft
- 74. LFR Drive Shaft

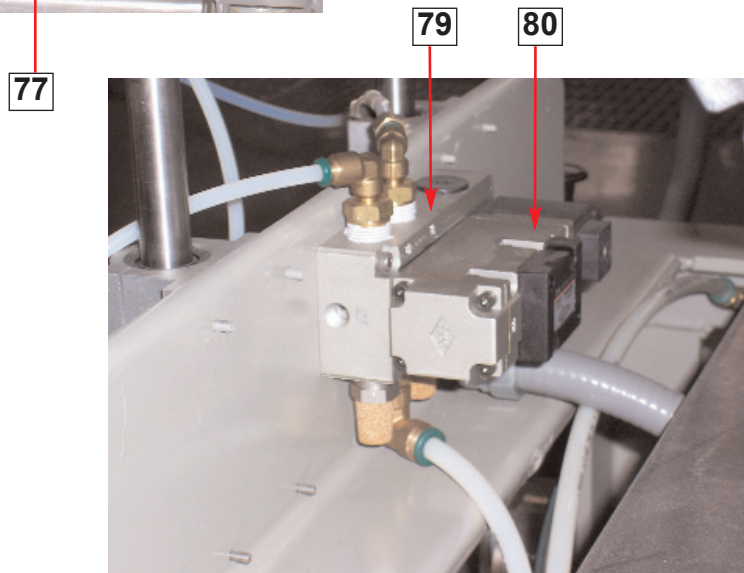
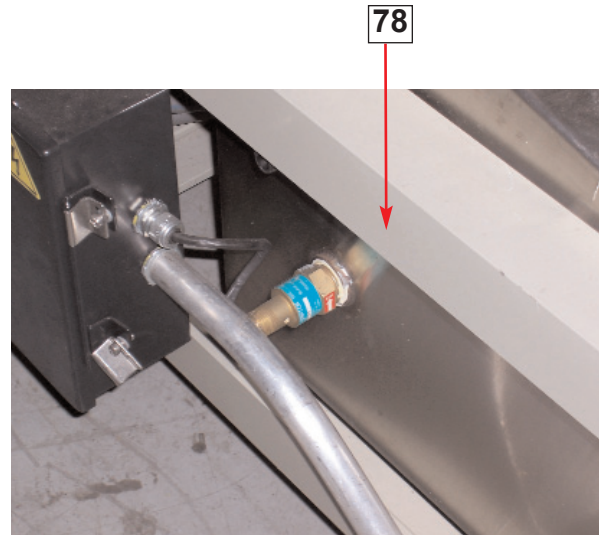
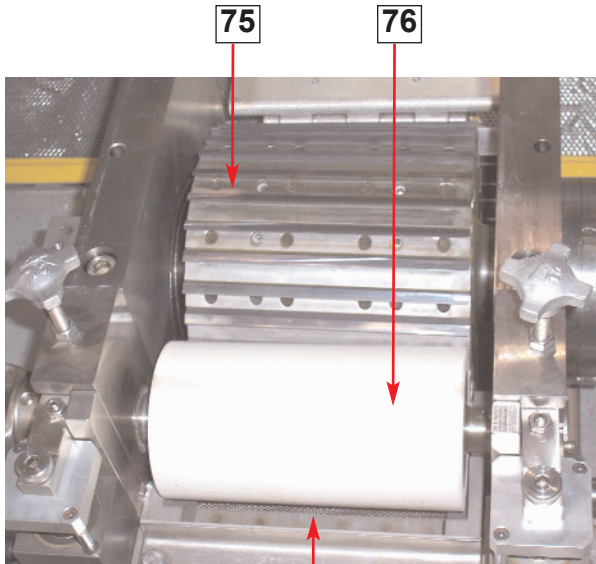

**Water Slide Pelletizer
200 Series**

- 75. Rotor
- 76. Upper Feed Roll
- 77. Lower Feed Roll
- 78. Electronic Float Sensor
- 79. Manifold
- 80. Solenoid Valve