

USER GUIDE
UGH030-0212

EarthSmart™ Portable Chillers

Water-cooled models ECW-1.5 to ECW-30
Air-cooled models ECA-1.5 to ECA-30



Please record your equipment's model and serial number(s) and the date you received it in the spaces provided.

It's a good idea to record the model and serial number(s) of your equipment and the date you received it in the User Guide. Our service department uses this information, along with the manual number, to provide help for the specific equipment you installed.

Please keep this User Guide and all manuals, engineering prints and parts lists together for documentation of your equipment.

Date:

Manual Number: UGH030-0212

Serial Number(s):

Model Number(s):

DISCLAIMER: The Conair Group, Inc., shall not be liable for errors contained in this User Guide or for incidental, consequential damages in connection with the furnishing, performance or use of this information. Conair makes no warranty of any kind with regard to this information, including, but not limited to the implied warranties of merchantability and fitness for a particular purpose.

Table of Contents

1-1 Introduction

Purpose of the user guide	1-2
How the guide is organized	1-2
Your responsibilities as a user	1-3
ATTENTION: Read this so no one gets hurt	1-4
How to use the lockout device (optional)	1-6

2-1 Description

What is the EarthSmart Portable Chiller?	2-2
Typical applications	2-3
Limitations	2-3
How it works: EarthSmart ECW Series (Water-cooled models)	2-4
Process circulation	2-4
Refrigerant circulation	2-5
How it works: EarthSmart ECA Series (Air-cooled models)	2-6
Process circulation	2-6
Refrigerant circulation	2-7
Portable chiller features	2-8
Water-cooled models	2-8
Air-cooled models	2-9
Specifications:	2-10
EarthSmart ECW Series (Water-cooled models)	2-10
EarthSmart ECA Series (Air-cooled models)	2-11
Pump curves	2-12
ECW Series (Water-cooled)	2-12
ECA Series (Air-cooled)	2-13
EarthSmart chiller options	2-14

3-1 Installation

Unpacking the boxes	3-2
Warnings and cautions	3-3
Preparing for installation	3-4
Making process plumbing connections	3-5
Filling the chiller	3-7
Checking refrigerant charge	3-9
Connecting the main power source	3-10
Checking electrical connections	3-12
Checking pump rotation	3-13
Checking the scroll compressor	3-14
Checking the water level gauge	3-14
Adjusting the bypass valve (optional).	3-15
Installing alarm indicators (optional)	3-16

4-1 Operation

Basic control features	4-4
EarthSmart Chiller control functions	4-5
Control function flow charts	4-5
How to navigate the menu tree	4-5
EarthSmart Chiller menu tree	4-6
Control function descriptions	4-14
Before starting	4-40
Starting the chiller	4-41
Stopping the chiller	4-42
EarthSmart Chiller sequence of operation	4-43
Adjusting setpoint temperature	4-44
How to use the supervisor's password	4-45
Autotuning requirements	4-46
Autotuning procedure	4-46

Changing from fahrenheit to celsius units	4-49
Enabling/Disabling display decimal point for temperature	4-50
Glycol operation enable/disable	4-51
Adjusting the process variable selection	4-52
Autofill enable/disable (optional)	4-53
Setting serial Modbus communication ID	4-54
Adjusting serial baud rate	4-55
Setting alarm parameters	4-56
Adjusting the low pressure inhibit time	4-56
Adjusting the low pressure delay time	4-58
Adjusting the flow switch alarm inhibit time	4-59
Adjusting the flow switch alarm delay time	4-60
Adjusting the process high alarm setpoint	4-61
Adjusting the process high alarm inhibit time	4-62
Adjusting the process high alarm delay time	4-63
Adjusting the process high temperature shutdown setpoint	4-64
Adjusting the process high temperature shutdown inhibit time	4-65
Adjusting the process high temperature shutdown delay time	4-66
Adjusting the process low alarm setpoint	4-67
Adjusting the process low alarm inhibit time	4-68
Adjusting the process low alarm delay time	4-69
Adjusting the process deviation high alarm setpoint	4-70
Adjusting the process deviation low alarm setpoint	4-71
Adjusting the process deviation high alarm inhibit time	4-72
Adjusting the process deviation high alarm delay time	4-73
Adjusting the process deviation low shutdown alarm setpoint	4-74
Enabling/Disabling process loop break	4-75
Adjusting the process loop breaker timer	4-76
Adjusting the alarm silence timer	4-77
Adjusting the autofill alarm timer	4-78
Adjusting the compressor cycles per hour alarm setpoint	4-79
Adjusting the freeze protection shutdown alarm setpoint	4-80

5-1 Maintenance

Maintenance features	5-2
Warnings and cautions	5-3
Preventative maintenance schedule	5-4
Checking electrical connections	5-6
Cleaning the brazed plate evaporator or water-cooled condenser	5-7
Cleaning the air-cooled condenser	5-10
Checking the refrigerant charge and quality	5-11
Checking the compressor's oil level	5-12
Checking the hot-gas bypass valve operation	5-14
Cleaning the evaporator and condenser "Y" strainer	5-16
Checking or cleaning the flow switch	5-20
Checking reservoir level	5-22
Checking pump performance	5-23
Reloading factory default parameters	5-24

6-1 Troubleshooting

Before beginning	6-2
Identify the cause of a problem	6-2
A few words of caution	6-3
<u>TROUBLESHOOTING</u>	
Chiller problems	6-4
Autotuning errors	6-6
Passive alarms	6-8
Shut down alarms	6-13
Additional alarms	6-20
Replacing the RTD	6-22
Removing pump components	6-23
Replacing the contactor	6-24

A Appendix

We're here to help	A-1
How to contact customer service	A-1
Before you call.....	A-1
Equipment guarantee	A-2
Performance warranty.....	A-2
Warranty limitations	A-2

B Appendix

Maintenance log	B-1
-----------------------	-----

C Appendix

Pressure tables	C-1
-----------------------	-----

D Appendix

Water quality control.....	D-1
----------------------------	-----

E Appendix

Overhead plumbing details	E-1
---------------------------------	-----

F Appendix

RTD resistance chart.....	F-1
---------------------------	-----

G Appendix

Installing autofill (optional)	G-1
--------------------------------------	-----

H Appendix

Cleaning the autofill valve (optional)	H-1
--	-----

I	Appendix	
	Compressor module troubleshooting	I-1
J	Appendix	
	Motor protection	J-1
K	Appendix	
	EarthSmart chiller - Serial Modbus communications	K-1
	EarthSmart chiller - Ethernet communications	K-2
	EarthSmart chiller Modbus and Ethernet communications. . .	K-4
L	Appendix	
	Pressure switch settings.	L-1
M	Appendix	
	Resetting the high pressure switch.	M-1

Introduction

Purpose of the user guide. 1-2

How the guide is organized. 1-2

Your responsibilities as a user. 1-3

ATTENTION:

 Read this so no one gets hurt 1-4

How to use the lockout device (optional). . . . 1-6

Purpose of the User Guide

This User Guide describes Conair's EarthSmart Portable Chiller and explains step-by-step how to install, operate, maintain and repair this equipment.

Before installing this product, please take a few moments to read the User Guide and review the diagrams and safety information in the instruction packet. You also should review manuals covering associated equipment in your system. This review won't take long, and it could save you valuable installation and operating time later.

How the Guide is Organized

Symbols have been used to help organize the User Guide and call your attention to important information regarding safe installation and operation.



Symbols within triangles warn of conditions that could be hazardous to users or could damage equipment. Read and take precautions before proceeding.

- 1** Numbers indicate tasks or steps to be performed by the user.
- ◆ A diamond indicates the equipment's response to an action performed by the user.
- ☐ An open box marks items in a checklist.
- A circle marks items in a list.
- ◆ Indicates a tip. A tip is used to provide you with a suggestion that will help you with the maintenance and the operation of this equipment.
-  Indicates a note. A note is used to provide additional information about the steps you are following throughout the manual.

Your Responsibility as a User

You must be familiar with all safety procedures concerning installation, operation and maintenance of this equipment. Responsible safety procedures include:

- Thorough review of this User Guide, paying particular attention to hazard warnings, appendices, and related diagrams.
- Thorough review of the equipment itself, with careful attention to voltage sources, intended use and warning labels.
- Thorough review of instruction manuals for associated equipment.
- Step-by-step adherence to instructions outlined in this User Guide.

ATTENTION:

Read this so no one gets hurt

We design equipment with the user's safety in mind. You can avoid the potential hazards identified on this machine by following the procedures outlined below and elsewhere in the User Guide.



WARNING: Improper installation, operation or servicing may result in equipment damage or personal injury.

This equipment should be installed, adjusted, and serviced by a qualified technician who is familiar with the construction, operation and potential hazards of this type of machine.

All wiring, disconnects, and fuses should be installed by a qualified electrical technician in accordance with electrical codes in your region. Always maintain a safe ground. Do not operate this equipment at power levels other than what is specified on the machine serial tag and data plate.



WARNING: Voltage hazard

This equipment is powered by three-phase alternating current, as specified on the machine serial tag and data plate.

A properly-sized conductive ground wire from the incoming power supply must be connected to the chassis ground terminal inside the electrical enclosure. Improper grounding can result in severe personal injury and erratic machine operation.

Always disconnect and lock out the incoming main power source before opening the electrical enclosure or performing non-standard operating procedures, such as routine maintenance. Only qualified personnel should perform troubleshooting procedures that require access to the electrical enclosure while power is on.

(continued)

ATTENTION:

Read this so no one gets hurt (continued)



CAUTION: Hot Surfaces

Always protect yourself from hot surfaces when working on the EarthSmart Portable Chiller, especially when working on or around the compressor and condenser. These devices can reach up to 160°F {71°C}. Allow these devices to cool before performing any maintenance or troubleshooting.



CAUTION: Ventilation hazard

The unit requires a clean and well ventilated operating environment. Do not place anything on top of the unit while operating. Units with top exhaust fans require unrestricted outlet air flow.

Water-cooled units require a minimum of 1 ft. {30.5 cm} clearance around the perimeter for serviceability. Conair recommends 2 ft. {60.9 cm} for ease of servicing. Air-cooled units require a minimum of 2 ft. {60.9 cm} clearance around the perimeter for serviceability and proper air flow.



WARNING: Refrigerant hazard

Only certified refrigerant technicians should examine and correct problems involving the refrigerant circuit.

How to Use the Lockout Device

(optional)

 **CAUTION:** Before performing maintenance or repairs on this product, you should disconnect and lockout electrical power sources to prevent injury from unexpected energization or start-up. A lockable device is available as an option to isolate the chiller from potentially hazardous electricity.

Lockout is the preferred method of isolating machines or equipment from energy sources. Your Conair EarthSmart Portable Chiller can be equipped with the optional lockout device pictured below.

To use the lockout device:

- 1 Stop or turn off the equipment.**
- 2 Isolate the equipment from the electric power.** Turn the rotary disconnect switch to the OFF or “O” position.
- 3 Secure the device with an assigned lock or tag.** Insert a lock or tag in the holes to prevent movement.
- 4 The equipment is now locked out.**

 **WARNING:** Before removing lockout devices and returning switches to the ON position, make sure that all personnel are clear of the machine, tools have been removed, and all safety guards re-installed.

To restore power to the chiller, turn the rotary disconnect back to the ON position:

- 1 Remove the lock or tag.**
- 2 Turn the rotary disconnect switch to the ON or “I” position.**

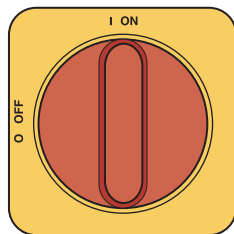
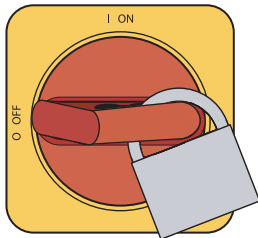
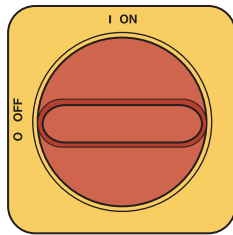

Description

What is the EarthSmart Portable Chiller? 2-2

Typical applications 2-3

Limitations 2-3

How it works: EarthSmart ECW Series

 (Water-cooled models) 2-4

 Process circulation 2-4

 Refrigerant circulation 2-5

How it works: EarthSmart ECA Series

 (Air-cooled models) 2-6

 Process circulation 2-6

 Refrigerant circulation 2-7

Portable chiller features 2-8

 Water-cooled models 2-8

 Air-cooled models 2-9

Specifications: 2-10

 EarthSmart ECW Series

 (Water-cooled models) 2-10

 EarthSmart ECA Series

 (Air-cooled models) 2-11

Pump curves 2-12

 ECW Series (Water-cooled) 2-12

 ECA Series (Air-cooled) 2-13

EarthSmart chiller options 2-14

What is the EarthSmart Portable Chiller?

The Conair EarthSmart Portable Chillers provide self-contained sources of chilled water and are available in either water- or air-cooled models. The EarthSmart Chillers have ranges from 1.5 Hp to 30 Hp with approximate capacities of 1.5 to 30 tons of refrigeration. Pump selections are available to match most process flow and pressure requirements.

Conair EarthSmart Portable Chillers are designed to provide chilled fluid for industrial applications requiring 24-hour-a-day performance. Units are totally self-contained for easy, economical installation. All parts wetted by the process are non-ferrous.

To operate, simply connect the power source, process piping and fill with water or with a mixture of water and industrial grade ethylene glycol or propylene glycol (**not** automotive antifreeze). Then set the process temperature.

These chillers are ideal for machine-side cooling to maintain process temperatures in an injection molding machine, extruder or wherever you need a small, moveable cooling unit. Nominal capacities range from 1.4 to 29.7 tons for the water-cooled models and 1.2 to 28.8 tons for the air-cooled models. Capacities are based on standard pump sizes and delivering 50°F {10°C} coolant.

Operation of these units differ only in the medium used to remove heat from the refrigerant in the condensers. Water-cooled models are rated to use 85°F {29°C} or lower cooling water from a tower, well, or city service; air-cooled models are rated to use ambient air up to 95°F {35°C}.

Typical Applications

The Conair EarthSmart Portable Chiller can be used anywhere a reliable source of process cooling water - with stable temperature control - is required.

Portable chillers are available for:

- Injection molding
- Thermoforming
- Air compressors
- Anodizing
- Degreasing
- Dryer intercoolers/aftercoolers.
- Blow molding
- Extrusion
- Metal plating
- Laser
- Heatset/web offset printing presses

Limitations

EarthSmart Portable Chillers should be chosen based upon:

- **Cooling load** - Select a chiller that has 0 - 10% more capacity than the process load.
- **Location** - Choose a water-cooled chiller when tower water or another inexpensive water source is available. Choose an air-cooled model for maximum portability of the unit or if an inexpensive water source is unavailable.
- **Temperature** - The normal temperature range of discharge chilled water is 20°F to 70°F {-6.7°C to 21.1°C}. For applications requiring 40°F {4.4°C} and lower process fluid temperatures, mix an industrial grade ethylene or propylene glycol with the water to the correct percentage, by volume, to protect against process freezing. *See Installation section entitled, Filling the Chiller.*

Use this information as a general guide. Consult your Conair representative for assistance when choosing a Conair EarthSmart Portable Chiller.

How it Works: EarthSmart ECW Series (Water-cooled Models)

Process circulation

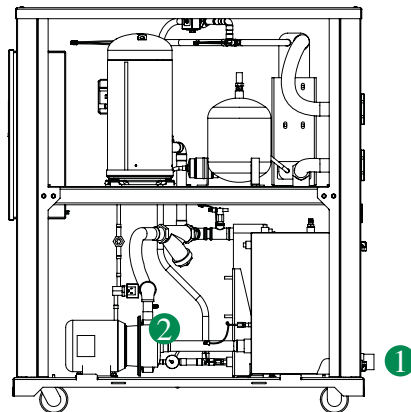

(right-side as view from the control panel)

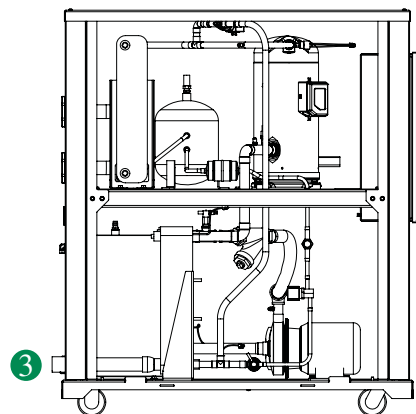

(left-side as view from the control panel)

- 1 Hot fluid from the process enters the chiller through the “**From Process**” connection into the pump reservoir.
- 2 The pump draws water from the pump reservoir and moves it through the strainer and flow switch to the evaporator.
- 3 The process fluid is chilled in the evaporator and exits through the “**To Process**” connection, returning to the process.

How it Works: EarthSmart ECW Series (Water-cooled Models) (continued)

Refrigerant circulation

- 1 The evaporator extracts heat from the process fluid, causing the refrigerant to vaporize (evaporate) into a gas.
- 2 Vaporized refrigerant travels from the evaporator to the compressor, where the low-pressure vapor is compressed into a high-pressure, high-temperature vapor.
- 3 The high-pressure, high-temperature vapor from the compressor travels to the condenser.
- 4 The high-pressure, high-temperature vapor travels from the condenser to the receiver. Water tower or city water removes heat from the vapor, condensing it to a high-pressure, high-temperature liquid.
- 5 High-pressure, high-temperature liquid is metered back to the evaporator by the expansion valve (TXV), changing it to a low-pressure, low-temperature liquid/vapor.

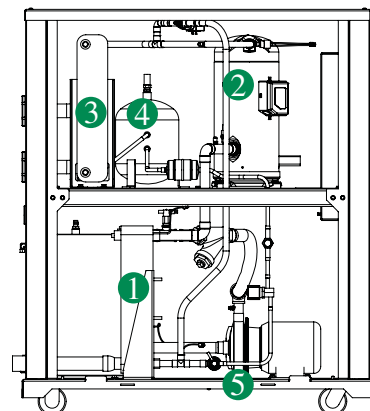

(left-side as view from the control panel)

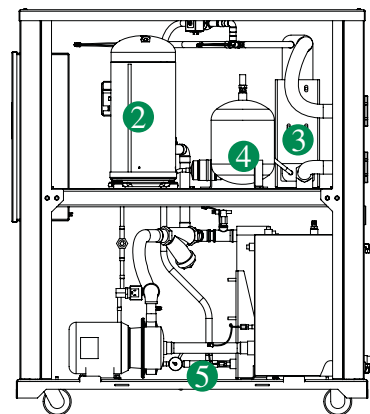

(right-side as view from the control panel)

How it Works EarthSmart ECA Series (Air-cooled Models)

Process circulation

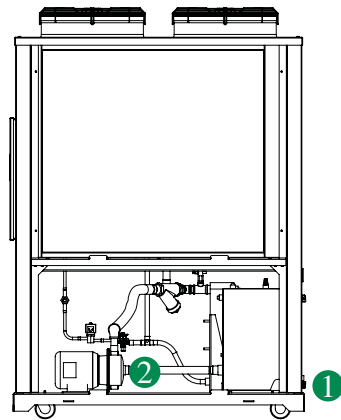

(right-side as view from the control panel)

- 1 Hot fluid from the process enters the chiller through the **“From Process”** connection into the pump reservoir.
- 2 The pump moves fluid from pump reservoir through evaporator where it is chilled.
- 3 The process fluid is chilled in the evaporator and exits through the **“To Process”** connection, returning to the process.

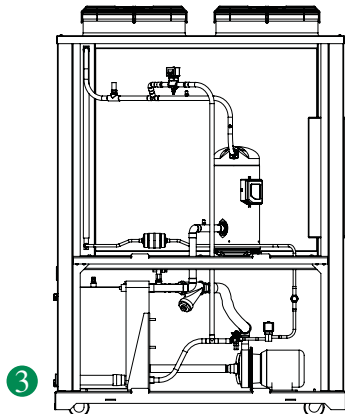

(left-side as view from the control panel)

How it Works: EarthSmart ECA Series (Air-cooled Models) (continued)

Refrigerant circulation

- 1 The evaporator extracts heat from the process fluid, causing the refrigerant to vaporize (evaporate) into a gas.
- 2 Vaporized refrigerant travels to the compressor, where the low-pressure vapor is compressed into a high-pressure, high-temperature vapor.
- 3 The high-pressure, high-temperature vapor travels from the compressor through the condenser, where the fan cools and condenses the vapor into a high-pressure, high-temperature liquid.
- 4 High-pressure, high-temperature liquid is metered back to the evaporator by the expansion valve (TXV), changing it to a low-pressure, low-temperature liquid/vapor.

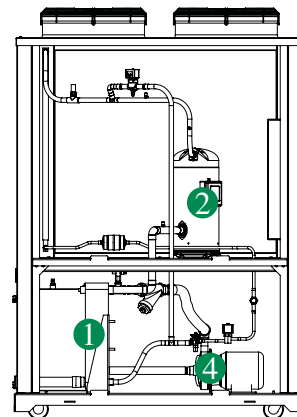

(left-side as view from the control panel)

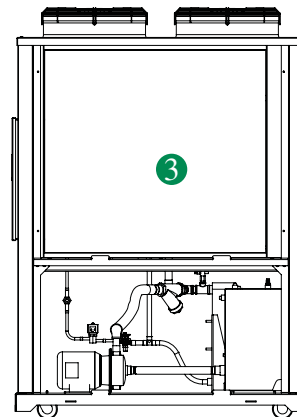

(right-side as view from the control panel)

Portable Chiller Features

(Water-cooled models)

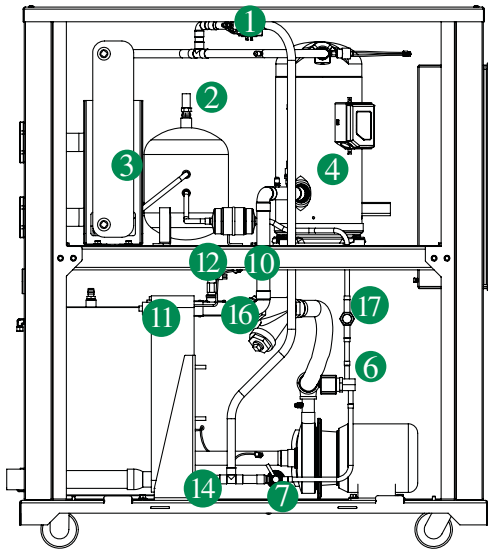

(left-side as view from the control panel)

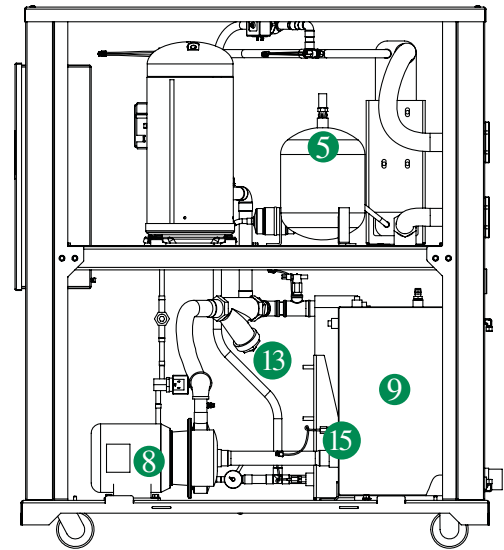

(right-side as view from the control panel)

- ① Hot-gas bypass valve (HGBP)
- ② Relief valve
- ③ Condenser
- ④ Compressor
- ⑤ Receiver
- ⑥ Liquid line solenoid valve (LLSV)
- ⑦ TX valve (Expansion valve)

- ⑩ Filter dryer
- ⑪ Evaporator
- ⑫ Flow switch
- ⑬ “Y” strainer
- ⑭ “To” temperature sensor
- ⑮ “From” temperature sensor
- ⑯ Evaporator temperature sensor
- ⑰ Liquid line sight glass

Portable Chiller Features (continued)

(Air-cooled models)

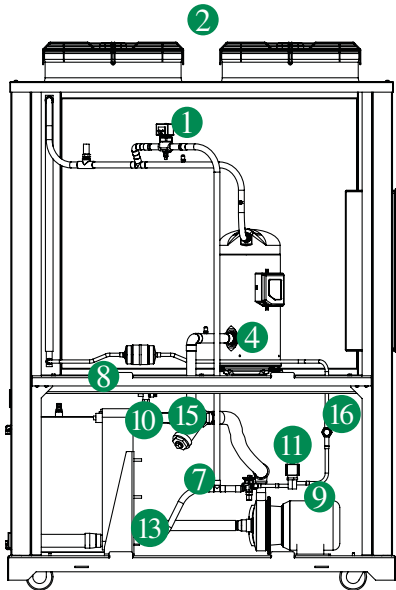

(left-side as view from the control panel)

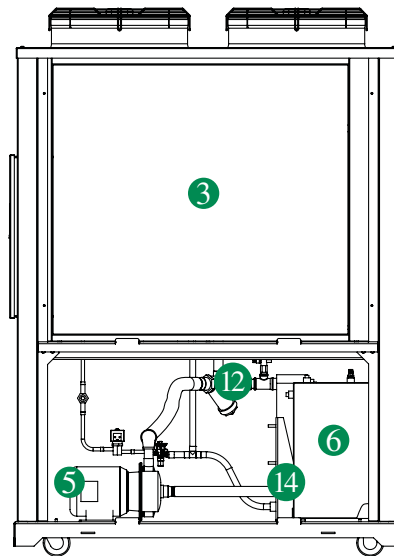

(right-side as view from the control panel)

- ① Hot-gas bypass valve (HGBP)
- ② Fan(s)
- ③ Condenser
- ④ Compressor
- ⑤ Process pump
- ⑥ Pump reservoir
- ⑦ Evaporator
- ⑧ Filter dryer
- ⑨ TX valve (Expansion valve)

- ⑩ Flow switch
- ⑪ Liquid line solenoid valve (LLSV)
- ⑫ “Y” strainer
- ⑬ “To” temperature sensor
- ⑭ “From” temperature sensor
- ⑮ Evaporator temperature sensor
- ⑯ Liquid line sight glass

Specifications: EarthSmart ECW Series (Water-cooled Models)

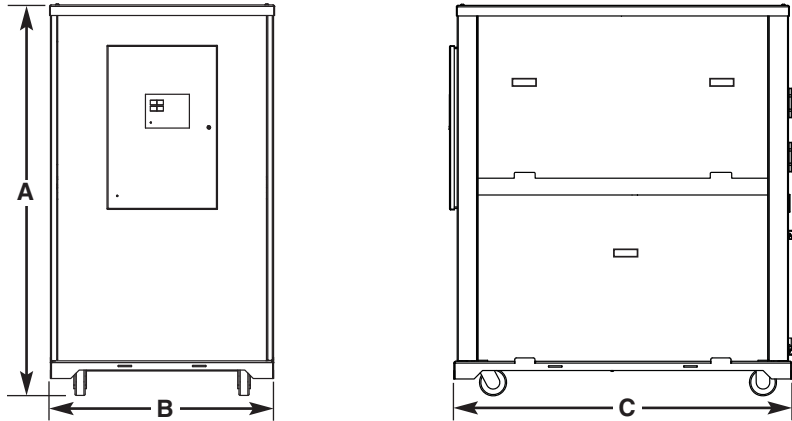

MODEL	ECW-1.5	ECW-3	ECW-5	ECW-7.5	ECW-10	ECW-15	ECW-20	ECW-25	ECW-30
Performance characteristics									
Nominal capacity* tons {kcal/hr}	1.6 {4,839}	2.9 {8,770}	5.5 {16,632}	7.5 {22,680}	10.1 {30,542}	15.3 {46,267}			
Compressor quantity/Hp {kW}	1 x 2.5 {1.9}	1 x 3.4 {2.6}	1 x 7.5 {5.6}	1 x 8.5 {6.3}	1 x 10 {7.5}	1 x 20 {15}			
Standard process pump† Hp {kW}	0.75 {0.56}	1.0 {0.75}	1.5 {1.1}	1.5 {1.1}	1.5 {1.1}	2 {1.5}			
Standard flow to process gpm {l/min}	3.4 {12.7}	7.2 {27.3}	12.0 {45}	18.0 {68}	24.0 {91}	33.0 {125}			
Reservoir capacity gal {l}	10 {37.9}	10 {37.9}	25 {94.6}	25 {94.6}	25 {94.6}	50 {189.3}			
Condenser water flow gpm {l/min}	4.5 {17}	9 {34}	15 {57}	22.5 {85}	30 {114}	45 {170}			
Dimensions in. {mm}									
A - Height	39 {991}	39 {991}	55 {1270}	55 {1270}	58 {1473}	67 {1702}			
B - Width	27 {686}	27 {686}	33 {838}	33 {838}	33 {838}	43 {1092}			
C - Length	40 {1016}	40 {1016}	46 {1168}	46 {1168}	50 {1270}	57.5 {1461}			
Weight lb {kg}									
Installed	450 {204}	475 {216}	685 {311}	1130 {513}	1240 {563}	1480 {671}			
Shipping	500 {227}	525 {238}	735 {333}	1180 {535}	1290 {585}	1530 {694}			
Process connections NPT in. {mm}	1 {25}	1 {25}	1.5 {38}	1.5 {38}	1.5 {38}	2 {51}			
Condenser connections NPT in. {mm}	1 {25}	1 {25}	1.5 {38}	1.5 {38}	1.5 {38}	2 {51}			
Voltages full load amps									
460/3 phase/60 Hz	6.4	10.3	15.0	21.8	23.9	34.0			
240/3 phase/50 Hz	NA	NA	NA	NA	NA	NA			
R-410A Refrigerant Charge lb {kg}									
	3 {1.4}	6 {2.7}	8 {3.6}	9 {4.1}	11 {4.9}	13 {5.9}			

Coming Soon!!!

SPECIFICATION NOTES:

* Based on supplying 50°F {10°C} water (no antifreeze) to process, standard pump selections, 85°F {29°C} condenser water supplied at 25 psi {1.7 bar} minimum and 60 Hz operation. Adjust capacities up 2% per degree for operation above 50°F {10°C} to a maximum of 65°F {18°C}. Likewise, lower capacities 2% per degree for operation below 50°F {10°C} to a minimum of 20°F {-7°C}. Capacities are +/- 5% based on the compressor manufacturer's ratings and are subject to change without notice. Consult factory for other conditions. Capacities change depending on option selection.

† Standard design based on 50°F {10°C} to process with 60°F {16°C} return from process.

Specifications may change without notice. Check with your Conair representative for the most current information.

TPHS038-0109

Specifications: EarthSmart ECA Series (Air-cooled Models)

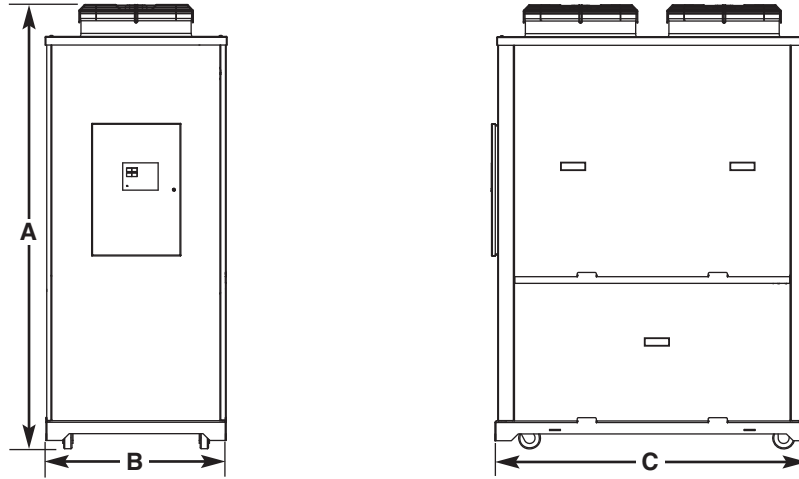

Description 2

MODEL	ECA-1.5	ECA-3	ECA-5	ECA-7.5	ECA-10	ECA-15	ECA-20	ECA-25	ECA-30
Performance characteristics									
Nominal capacity* tons {kcal/hr}	1.4 {4,234}	3 {9,072}	4.9 {14,817}	7.7 {23,285}	10.1 {30,542}	13.7 {41,428}			
Compressor quantity/Hp {kW}	1 x 2.5 {1.9}	1 x 4.7 {3.5}	1 x 7.5 {5.6}	1 x 11.3 {8.5}	1 x 14.8 {11}	1 x 20 {15}			
Standard process pump† Hp {kW}	0.75 {0.56}	1 {0.75}	1.5 {1.1}	1.5 {1.1}	1.5 {1.1}	2.0 {1.5}			
Standard flow to process gpm {l/min}	3.4 {12.7}	7.2 {27.3}	12.0 {45}	18.0 {68}	24.0 {91}	33.0 {125}			
Reservoir capacity gal {l}	10 {37.9}	10 {37.9}	25 {94.6}	25 {94.6}	25 {94.6}	50 {189.3}			
Fan quantity x Fan Hp {kW}	1 x 1.2 {0.86}	1 x 1.2 {0.86}	1 x 1.4 {1.05}	2 x 1.4 {1.05}	2 x 1.4 {1.05}	1 x 3.0 {2.25}			
Air flow cfm {l/min}	1500 {42,475}	2250 {63,713}	3850 {109,020}	5500 {155,743}	7700 {218,040}	9150 {259,100}			
Dimensions in. {mm}									
A - Height	55.0 {1270}	55.0 {1270}	68.0 {1727}	81.5 {2070}	81.5 {2070}	86.5 {2197}			
B - Width	27 {686}	27 {686}	33 {838}	33 {838}	33 {838}	43 {1092}			
C - Length	40.0 {1016}	40.0 {1016}	46.0 {1168}	57.5 {1461}	57.5 {1461}	57.5 {1461}			
Process connections NPT in. {mm}	1 {25}	1 {25}	1.5 {38}	1.5 {38}	1.5 {38}	2.0 {51}			
Weights lb {kg}									
Installed	485 {220}	535 {243}	1050 {476}	1540 {699}	1680 {762}	1850 {839}			
Shipped	535 {243}	580 {263}	1100 {499}	1590 {721}	1730 {785}	1900 {862}			
Voltages full load amps									
460/3 phase/60 Hz	6.4	9.5	17.2	19.6	24.1	38.2			
240/3 phase/50 Hz	NA	NA	NA	NA	NA	NA			
R-410A Refrigerant Charge lb {kg}									
	3 {1.4}	6 {2.7}	10 {4.5}	17 {7.7}	18 {8.2}	20 {9.1}			

Coming Soon!!!

SPECIFICATION NOTES:

* Based on supplying 50°F {10°C} water (no antifreeze) to process, standard pump selections, a maximum of 95°F {35°C} ambient air and 60 Hz operation. Adjust capacities up 2% per degree for operation above 50°F {10°C} to a maximum of 65°F {18°C}. Likewise, lower capacities 2% per degree for operation below 50°F {10°C} to a minimum of 20°F {-7°C}. Capacities are +/- 5% based on the compressor manufacturer's ratings and are subject to change without notice. Consult factory for other conditions. Capacities change depending on option selection.

† Standard design based on 50°F {10°C} to process with 60°F {16°C} return from process.

Specifications may change without notice. Check with your Conair representative for the most current information.

TPHS037-0209

Pump curves - ECW Series (Water-cooled)

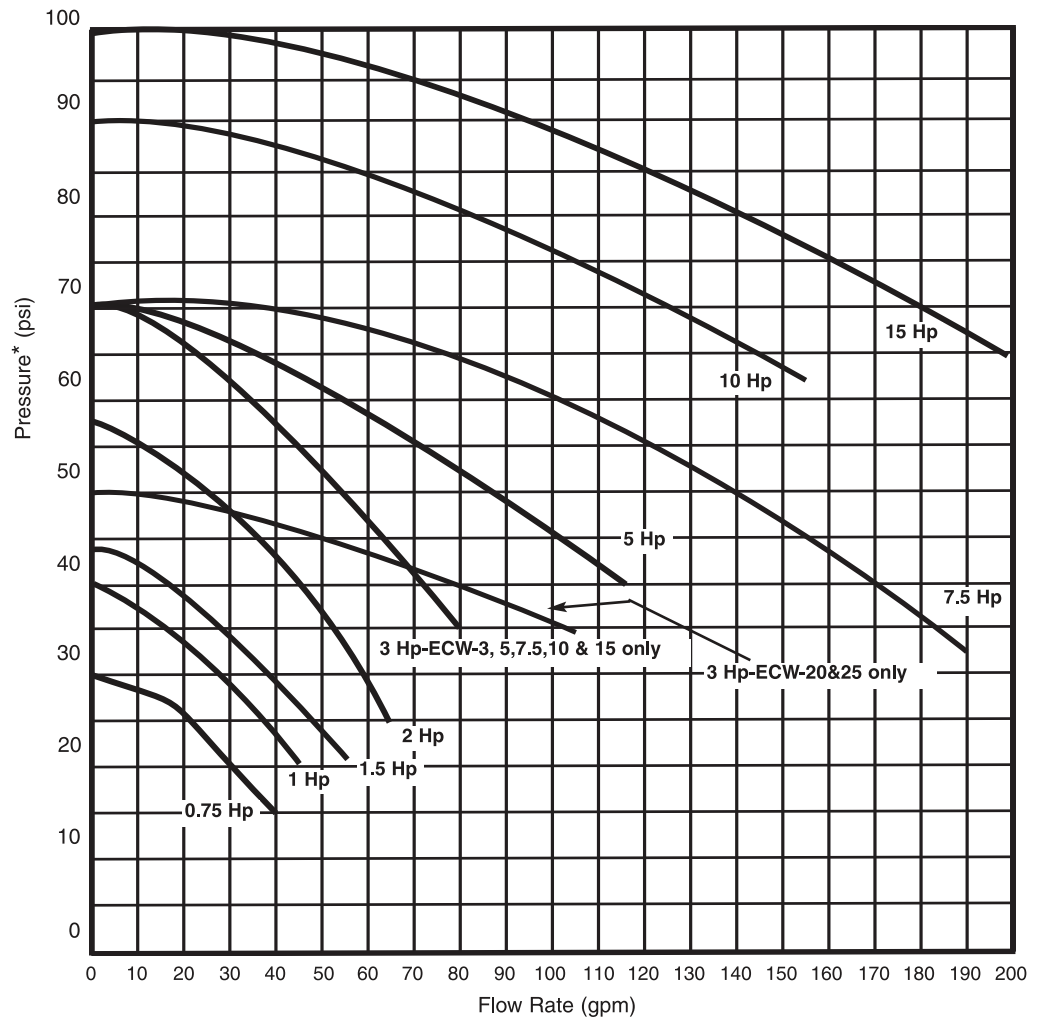

SPECIFICATION NOTES

* Pump curves do not reflect pressure drops due to internal piping.

These pump curves are non-overloading using the service factor of the motors.

Specifications may change without notice. Check with your Conair representative for the most current information.

TPHx038-0109

Pump curves - ECA Series (Air-cooled)

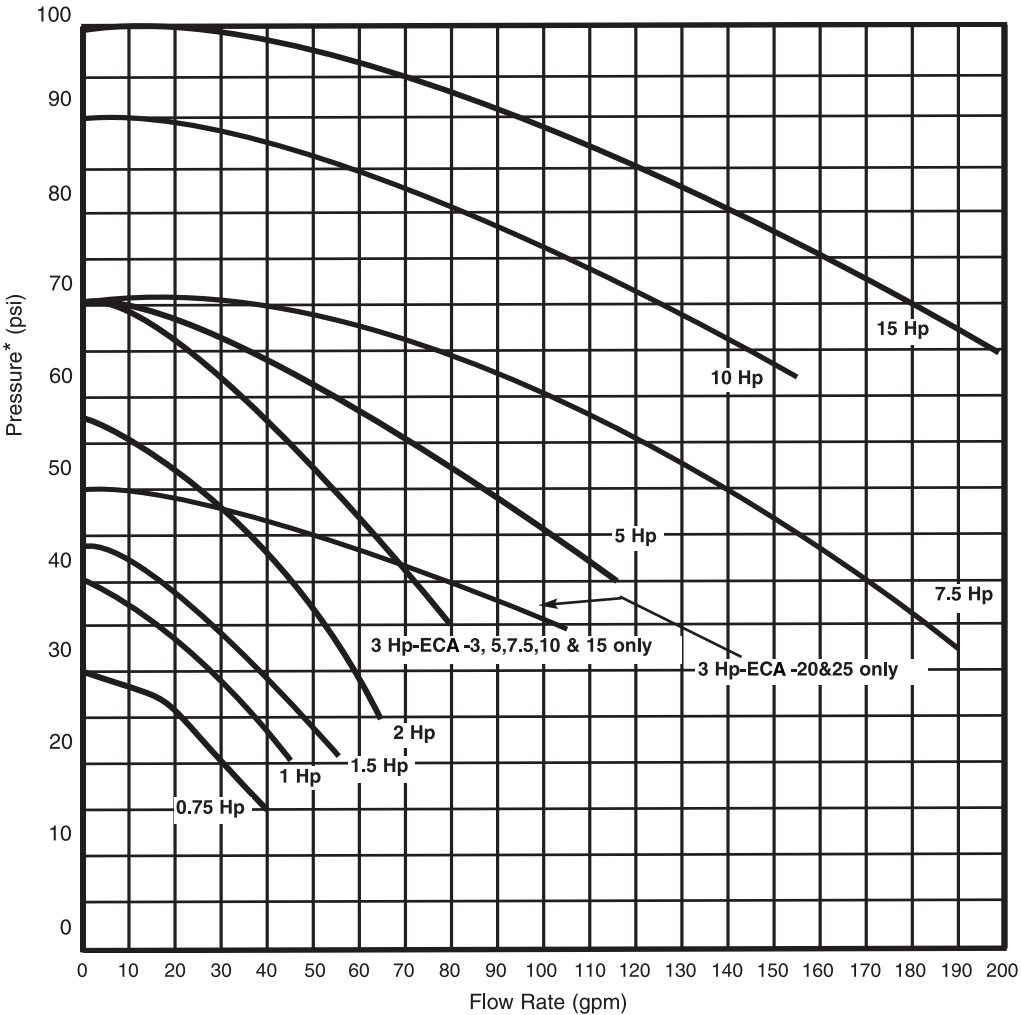

SPECIFICATION NOTES

* Pump curves do not reflect pressure drops due to internal piping.

These pump curves are non-overloading using the service factor of the motors.

Specifications may change without notice. Check with your Conair representative for the most current information.

TPHx037-0209

EarthSmart Chiller Options

- **Alarm kit** – Highly visible strobe light and an alarm beacon indicate chiller alarm conditions.
- **Extended compressor warranty** – Warranty extension covers the compressor(s) *only* for an additional 2 years. Labor, refrigerant or any other chiller parts are not included during the extended warranty period.
- **Autofill** – Reservoir level sensor and solenoid to allow connection to city water for automatic water make-up. (Not recommended when the chiller is using a water and Glycol mixture.)
- **Process water bypass with valves** – Includes process water valves and a pre-piped, external bypass line with bypass valve for low flow/high delta T processes which would limit flow through the chiller.

Installation

Unpacking the boxes	3-2
Warnings and cautions	3-3
Preparing for installation	3-4
Making process plumbing connections	3-5
Filling the chiller	3-7
Checking the refrigerant charge	3-9
Connecting the main power source	3-10
Checking electrical connections	3-12
Checking pump rotation	3-13
Checking the scroll compressor	3-14
Checking the water level gauge	3-14
Adjusting the bypass valve (optional)	3-15
Installing alarm indicators (optional)	3-16

Unpacking the Boxes

EarthSmart Portable Chillers come fully assembled in a single crate. Some air-cooled units are shipped without the casters attached. The casters **must** be attached during unpacking.



CAUTION: Lifting

EarthSmart Portable Chillers are designed to easily roll on casters. If, for some reason you need to lift the chiller, take all precautions to avoid personal injury or damage to the chiller. Lift the chiller using a forklift or hoist with straps that have been positioned at the chiller's center of gravity. Do not try to lift the unit manually.

- 1 Carefully uncrate the chiller** and its components.
- 2 Remove all packing material**, protective paper, tape, and plastic. Compare contents to the shipping papers to ensure that you have all the parts.
- 3 Carefully inspect all components** to make sure no damage occurred during shipping. If any damage is found, notify the shipping agent immediately to file a claim. Check all wire terminal connections, bolts and any other electrical connections, which may have come loose during shipping. Check for pinched wires and kinked hoses.
- 4 Remove the bands holding the chiller on the pallet.**
- 5 With a forklift, lift the chiller high enough to attach the casters**, if shipped unattached. Thread the casters into the threaded plates on each corner of the unit.
- 6 Record serial numbers and specifications** for the chiller in the blanks provided on the back of the User Guide's title page. This information will be helpful if you ever need service or parts.

Warnings and Cautions



WARNING: Improper installation, operation or servicing may result in equipment damage or personal injury.

This equipment should only be installed, adjusted and serviced by a qualified technician who is familiar with the construction, operation and potential hazards of this type of machine.

All wiring, disconnects and fuses should be installed by a qualified electrical technician in accordance with electrical codes in your region. Always maintain a safe ground. Do not operate the equipment at power levels other than what is specified on the machine data plate.



CAUTION: Hot Surfaces

Always protect yourself from hot surfaces when working on the chiller, especially when working on or around the compressor and condenser. These devices can reach temperatures up to 160°F {71°C}. Allow these devices to cool before performing any maintenance or troubleshooting.



CAUTION: Ventilation hazard

The unit requires a clean and well ventilated operating environment. Do not place anything on top of the unit while operating. Units with top exhaust fans require unrestricted outlet air flow.

Water-cooled units require a minimum of 1 ft. {30.5 cm} clearance around the perimeter for serviceability. Conair recommends 2 ft. {60.9 cm} for ease of servicing. Air-cooled units require a minimum of 2 ft. {60.9 cm} clearance around the perimeter for serviceability and proper air flow.



WARNING: Refrigerant hazard

Only certified refrigerant technicians should examine and correct problems involving the refrigerant circuit.

Preparing for Installation

Plan the location for the chiller and prepare the area properly.

Position the chiller as close to the process machine as possible. Place the chiller in position near the process machine so that coolant lines can be connected from the process machine to the chiller and back.

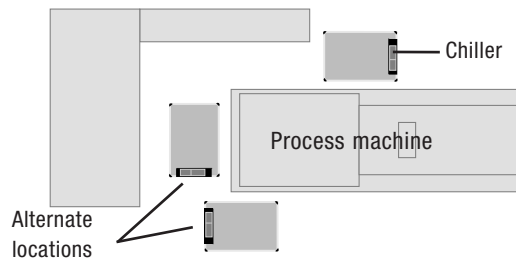

Make sure the area where the chiller is installed has:

A grounded power source.

Check the chiller's serial tag for the correct amps, voltage, phase and cycle. All wiring should be completed by a qualified personnel and comply with your region's electrical codes.

Clearance for safe operation and maintenance.

Make sure there is 2 ft. {60.9 cm} of clearance around the chiller for proper operation. After positioning, lock the casters to prevent the chiller from moving. For maintenance and servicing, be sure there is enough clearance to remove all access panels completely.

Available water source. (water-cooled only)

If installing a water-cooled unit, ensure that the water source is plumbed to the chiller's installation location. High points in the plumbing require vent valves; low points require drain valves.

Available water source for Autofill (optional)

If installing a chiller with the optional Autofill function, ensure that the water source is plumbed to the chiller's installation location. *See Installation section entitled, Filling the Chiller.*

 **NOTE:** Air-cooled models must be positioned so that the condenser air inlet is no warmer than 95°F {35°C} and the condenser air outlet is not blocked or restricted in any way.

 **NOTE:** Locate air-cooled models away from heat producing equipment. These items will affect ambient air conditions and the performance of the chiller.

Making Process Plumbing Connections

Warm fluid from the process equipment enters the chiller at the “**From Process**” connection and chilled fluid returns to the process equipment through the “**To Process**” connection.

- 1 Remove the shipping plastic pipe plugs from the female connections** on the back of the EarthSmart Chiller.
- 2 Make sure the connecting process tubing male pipe threads are clean and new.**
- 3 Wrap the male pipe threads with Teflon tape or pipe dope.**
- 4 Connect the “From Process” valve (factory option) on the back of the chiller to the “From Process” tubing.** Start by hand until the threads engage and then tighten with a pipe wrench. Tighten only enough to prevent leaks; do not over-tighten.
- 5 Connect the “To Process” valve (factory option) on the back of the chiller to the “To Process” tubing.** Start by hand until the threads engage and then tighten with a pipe wrench. Tighten only enough to prevent leaks; do not over-tighten. If process lines are higher than the chiller, *see Appendix E, entitled Overhead Plumbing Details.*

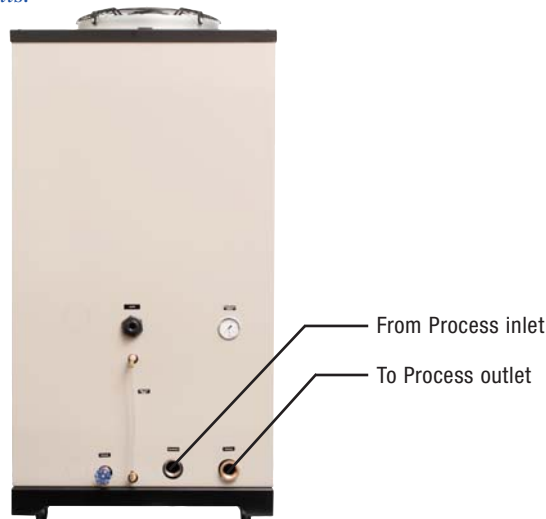

(Air-cooled model shown)

 **NOTE:** The optional “To” and “From Process” valve locations may vary depending on the model.

Making Process Plumbing Connections (continued)

For water-cooled chillers, connect the water source for cooling to the condenser water inlet on the back of the chiller, then connect the condenser water outlet for returning cooling water. **Seal all connections with Teflon or pipe dope.**

Water-cooled chiller

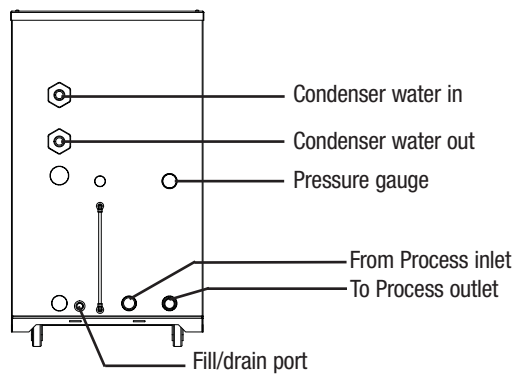

Air-cooled chillers do not require condenser water connections. The condenser for these models will be cooled by an exhaust fan located on top of the chiller.

Air-cooled chiller

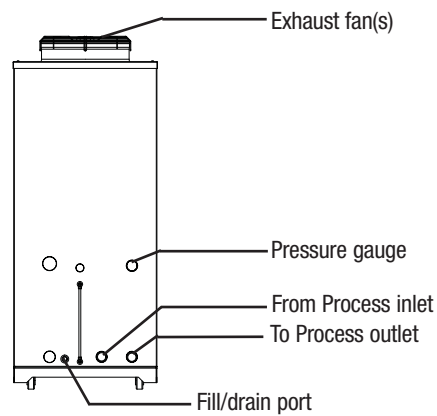



Filling the Chiller

EarthSmart Chillers are shipped without coolant. The chiller is filled manually during installation. Use water as the coolant down to 40°F {4.4°C}. Below 40°F {4.4°C} and down to 20°F {-6.7°C}, use an industrial grade ethylene or propylene glycol and water mixture. *See Installation section entitled, Filling the Chiller; Percent Glycol vs. Temperature Chart.*

To fill with water:

- 1 Attach the water supply to Fill/Drain valve or the optional Autofill port.**
- 2 Close the “To Process” and “From Process” valves. (factory optional)**
- 3 Open the Fill/Drain valve or water supply (Autofill option) and fill chiller to the recommended level of 3/4 full on the water level gauge.** If the chiller is overfilled, the excess water spills out the vent tube. **DO NOT OVERFILL.**
- 4 Close the Fill/Drain valve.**
- 5 Check the coolant level.** When the chiller is turned on the coolant level drops as it begins to circulate, filling the connected plumbing. Check the coolant level on the back of the chiller. The coolant level shows on the water level gauge. Make sure the coolant level is filled to the recommended 3/4 full on the water level gauge. Turn off the chiller and add more coolant, if needed.
- 6 Disconnect water hose from Fill/Drain valve.** The optional Autofill port does not need to be disconnected unless the chiller is to be used elsewhere.

 **NOTE:** If your chiller has the optional Autofill function, the level switch will automatically fill the reservoir, after power is supplied, with water as needed. *See Appendix G entitled, Installing Autofill (optional).*

 **NOTE:** If the optional Autofill function overfills your chiller’s reservoir the Autofill timer delay will need to be adjusted. *See Operation section entitled, Adjusting the Autofill Timer Delay.*

 **NOTE:** The optional “To” and “From Process” valve locations may vary depending on the model.

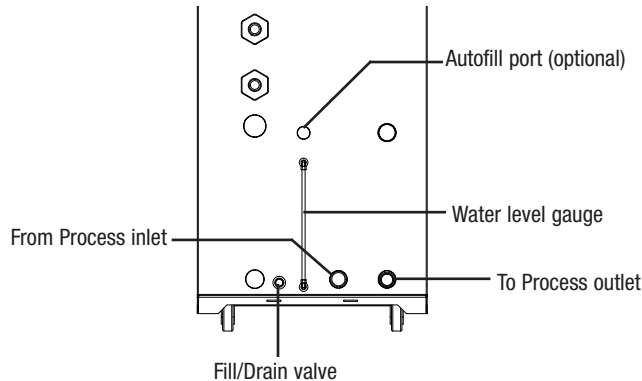

Optional Autofill hardware is available from Conair.

Contact Conair Parts
 (800) 458 1960
 From outside of the
 United States, call:
 (814) 437 6861

Filling the Chiller (continued)

IMPORTANT: When using a glycol mixture, the EarthSmart Chiller control MUST be enabled for glycol usage. See *Operation section entitled, Glycol Operation Enable/Disable*.

IMPORTANT: The EarthSmart Chiller control does **NOT** monitor the mixture of water to glycol.

 **NOTE:** When using a glycol mixture, the use of the optional Autofill function is **not** recommended.

To fill with glycol solution:

- 1 Mix the glycol to the proper percentage.** Use the table below to determine the percentage (by volume) of glycol needed for the process temperature (in °F) required. Mix the proper percentage of glycol with water.

Recommended Percentages of Glycol for Chilled Water Freeze Protection (by volume)		
Discharge water Temperature	% Propylene Glycol	% Ethylene Glycol
Above 45°F	0	0
40°F	20	15
35°F	25	20
30°F	35	30
25°F	40	35
20°F	45	40
Below 20°F	Consult Factory	

- 2 Close the “To Process” and “From Process” valves. (factory optional)**
- 3 Open the Fill/Drain valve or water supply (Autofill option) and the fill chiller to the recommended level of 3/4 full on the water level gauge.** If the chiller is overfilled, the excess coolant spills out the vent tube. **DO NOT OVERFILL.**
- 4 Close the Fill/Drain valve.**
- 5 Check the coolant level.** The coolant level drops as it begins to circulate and fill the connected plumbing. Check the coolant level on the back of the chiller. The coolant level shows on the water level gauge. Make sure the coolant level is filled to the recommended 3/4 full level on the water level gauge. Turn off the chiller and add more coolant, if needed.
- 6 Disconnect water hose from Fill/Drain valve.**

Checking the Refrigerant Charge

⚠ WARNING: Refrigerant hazard

Only certified refrigerant technicians should examine and correct problems involving the refrigerant circuit.

⚠ CAUTION: Always disconnect and lock out the main power sources before making electrical connections. Electrical connections should be made only by a qualified electrical technician.

All EarthSmart Chillers are fully charged with R-410A refrigerant from Conair. *See Description section entitled, Specifications: EarthSmart ECW and ECA Series, for required refrigerant charges.*

Check refrigerant charge while the chiller is running. Check the refrigerant charge through the sight glass. Remove the bottom left-side panel (depending on model) and check the sight glass.

- Under full load conditions**, the refrigerant should be clear (no bubbles).
- Under low load conditions**, when the Hot-gas Bypass valve is operating, bubbles may be visible in the sight glass. This is normal.

If the charge is low and the unit is under warranty, contact Conair service. Otherwise have a local, certified refrigeration technician add R-410A refrigerant to the system.

📌 NOTE: Leaving the air-cooled chiller side panels off for an extended period of time will cause the chiller to shut down due to a High Pressure alarm.

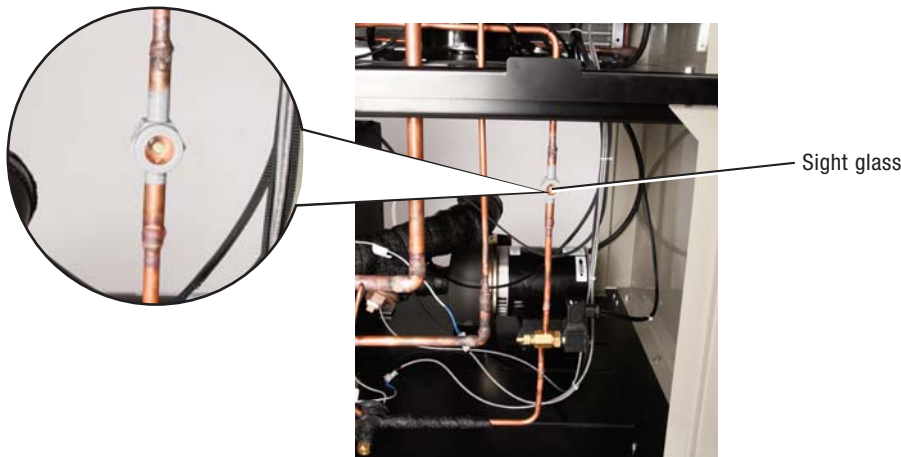

Connecting the Main Power Source



IMPORTANT: Always refer to the wiring diagrams that came with your chiller to locate specific electrical components. Illustrations in the User Guide are intended to be representative only.



WARNING: Improper installation, operation or servicing may result in equipment damage or personal injury.

This equipment should only be installed, adjusted and serviced by a qualified technician who is familiar with the construction, operation and potential hazards of this type of machine.

All wiring, disconnects and fuses should be installed by a qualified electrical technician in accordance with electrical codes in your region. Always maintain a safe ground. Do not operate the equipment at power levels other than what is specified on the machine data plate.



WARNING: Electrical hazard

Before performing any work on this equipment, disconnect and lock out electrical power sources to prevent injury from unexpected energization or startup.

1 Disconnect and lockout power to the chiller.

2 Open the chiller's electrical enclosure.



Connecting the Main Power Source

(continued)

3 Connect the power wires to the terminals. (See the wiring diagrams that came with your chiller). Route the power cable through the hole in the top of the electrical enclosure and secure it with an appropriate strain relief.

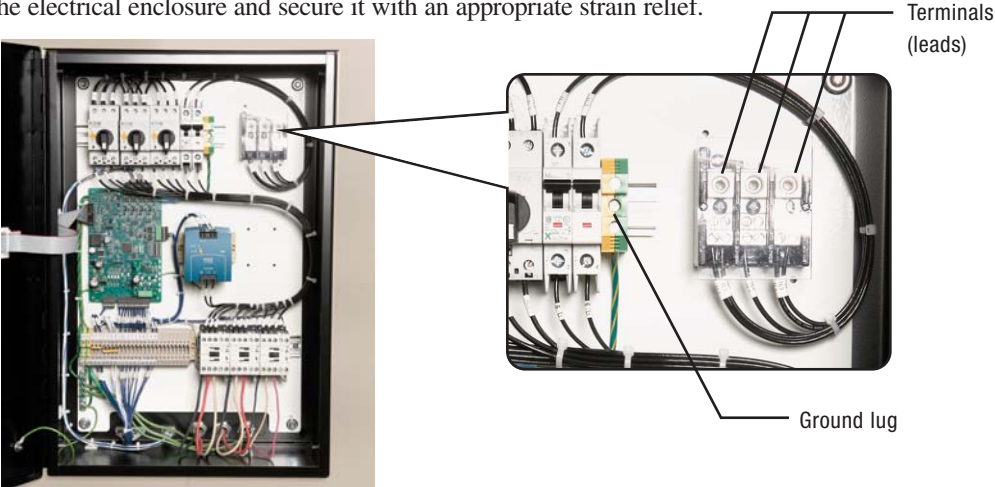

- 4** Check terminal screws to ensure that the wires are secure. Gently tug each wire, if a wire is loose, use an appropriately-sized screwdriver to tighten the terminals.
- 5** Connect the ground wire to the grounding lug.
- 6** Close the chiller’s electrical enclosure, once all connections have been made.



IMPORTANT: Always refer to the wiring diagrams that came with your chiller to locate specific electrical components. Illustrations in the User Guide are intended to be representative only.

Checking Electrical Connections



IMPORTANT: Always refer to the wiring diagrams that came with your chiller to locate specific electrical components. Illustrations in the User Guide are intended to be representative only.

IMPORTANT: Conair recommends checking all main wiring for loose connections before putting the chiller into service.



WARNING: Electrical Hazard

Before performing any work on this item, disconnect and lock out electrical power sources to prevent injury from unexpected energization or startup.

1 Disconnect and lockout power to the chiller.

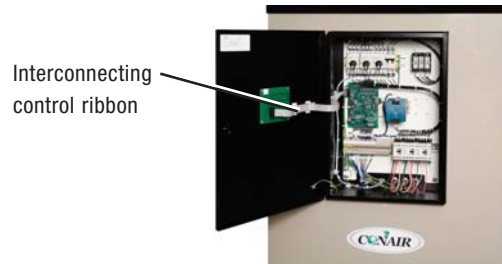

2 Open electrical enclosure.

3 Check the short-to-ground with an ohm meter. Connect an ohm meter to each of the three terminal screws and to the grounding lug. Test all three for resistance. The minimum resistance to ground should be 1 megohm. If its resistance is less than 1 megohm there is a leak in the system.

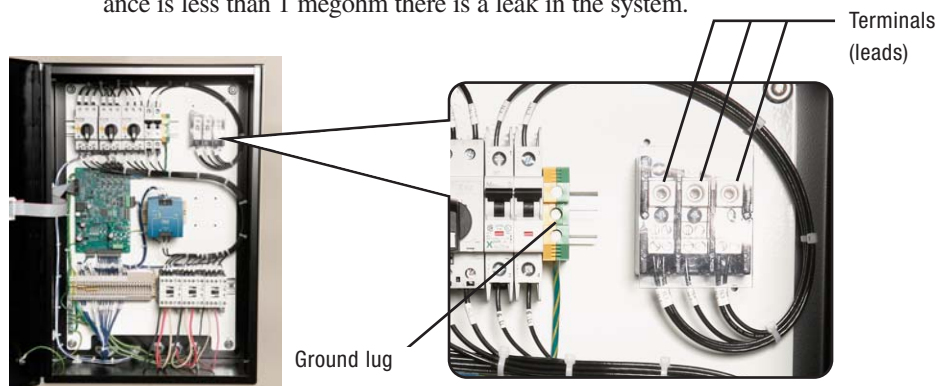

4 Close the electrical enclosure.

5 Turn the optional disconnect switch to the “On” position and/or apply main power.

Checking Pump Rotation

 **WARNING:** All wiring, disconnects and fuses should be installed by a qualified electrical technician in accordance with electrical codes in your region. Always maintain a safe ground. Do not operate the equipment at power levels other than what is specified on the the machine serial tag and data plate.

To check for proper pump rotation:

- 1 Press and hold the “Start” button  for seven (7) seconds to activate Manual Pump mode, “nnAn” and the setpoint will flash on the chiller’s dual LED display. Press the “Stop” button  to turn off the pump and to exit Manual Pump mode.

 **IMPORTANT:** Always refer to the wiring diagrams that came with your chiller to locate specific electrical components. Illustrations in the User Guide are intended to be representative only.

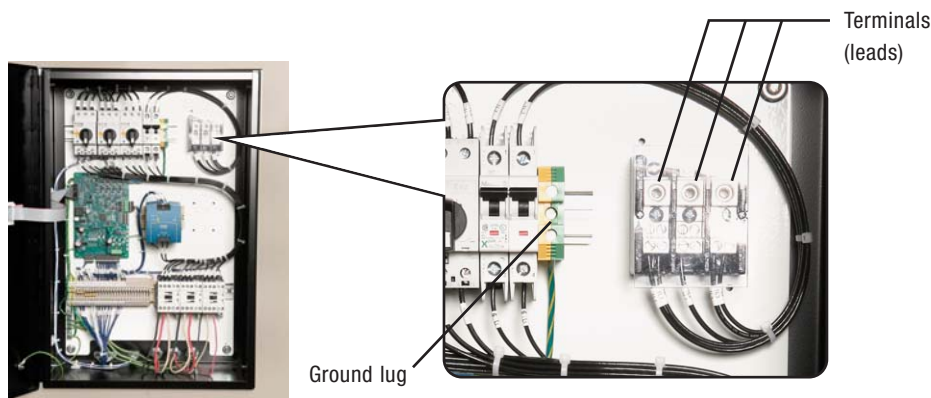

 If pump rotation is reversed, the pump motor is turning in the wrong direction. Turn off and lock out the main power source. Open the electrical enclosure and reverse any two leads connecting the main power supply to the chiller.

- 2 **Check for proper pump rotation.** Compare the pump rotation from the motor end to the arrow direction indicator on the pump. (Always clockwise)

- 3 **Disconnect main power to the chiller if the pump is not rotating in the proper direction,** swap any two incoming power wires; reapply main power.

- 4 Press the “Stop” button  after correct rotation has been established. Check for leaks in the process piping both internal and external; fix any leaks and dry the inside of the chiller before proceeding.

Checking the Scroll Compressor



IMPORTANT: Always refer to the wiring diagrams that came with your chiller to locate specific electrical components. Illustrations in the User Guide are intended to be representative only.



NOTE: If correct pump rotation was established, the compressor rotation will be correct. Both the pump and compressor are phased together during manufacturing.



WARNING: All wiring, disconnects and fuses should be installed by a qualified electrical technician in accordance with electrical codes in your region. Always maintain a safe ground. Do not operate the equipment at power levels other than what is specified on the the machine serial tag and data plate.

Pump rotation, if done correctly by reversing leads at the incoming power, will provide proper rotation for the rest of the three phase motors within the chiller. You will not be able to determine compressor rotation unless you have refrigeration gauges.

To check the scroll compressor:

- 1 Inspect the compressor.** If the compressor is wired incorrectly, the compressor LED on the control will illuminate but the compressor will not run. *See Appendix J entitled, Motor Protection.*
- 2 Disconnect main power to the chiller if the pump is not rotating in the proper direction,** swap any two incoming power wires; reapply main power. Wait three minutes. The compressor should now be running in the proper direction. *See Installation section entitled, Checking Pump Rotation.*

Checking the Water Level Gauge

Check the water level gauge on the back of the chiller. If the coolant level below the 3/4 level, *see Installation section entitled, Filling the Chiller.*

Water level gauge

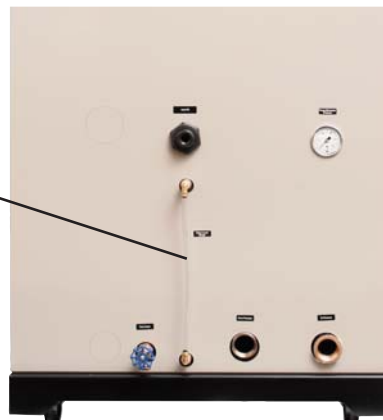

Adjusting the Bypass Valve (optional)

The optional Bypass valve is used when the chiller’s process flow is regulated by an auxiliary piece of equipment, such as a thermolator. Correct water flow through the Bypass valve must be made before normal operation of the chiller can be established. *See Description section entitled, Specifications: EarthSmart ECW and ECA Series and Maintenance section entitled, Checking Pump Performance for water flow requirements.*

To adjust the Bypass valve:

- 1** Close the “To Process” and “From Process” valves (factory optional).
- 2** Turn the Bypass valve adjustment to the fully opened position.



- 3** Manually start the chiller’s pump. *See Installation section entitled, Checking Pump Rotation.*
- 4** While the pump is running, slowly close the bypass valve until “FSL” (Flow Switch Loss) is displayed in the chiller’s readout. Once this error is displayed, the chiller will shutdown.
- 5** Open the bypass valve slightly and manually restart the pump. *See Installation section entitled, Checking Pump Rotation.*
- 6** If the “FSL” alarm reappears and the pump shuts off, continue slightly opening the Bypass valve and manually restarting the pump until the alarm no longer appears.
- 7** Open the “To Process” and “From Process” valve (factory optional), the chiller is now ready for normal operation.

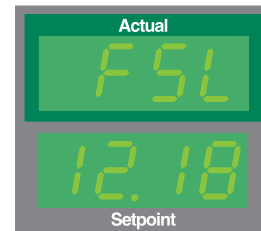

Installing Alarm Indicators (optional)



IMPORTANT: Always refer to the wiring diagrams that came with your chiller to locate specific electrical components. Illustrations in the User Guide are intended to be representative only.



WARNING: All wiring, disconnects and fuses should be installed by a qualified electrical technician in accordance with electrical codes in your region. Always maintain a safe ground. Do not operate the equipment at power levels other than what is specified on the the machine serial tag and data plate.

The EarthSmart Chiller is available with optional alarm indicators (a beacon and strobe light) to alert the user to alarm conditions. Installation of the optional alarm indicators is required only if they have not been installed from Conair.

To install the optional alarm beacon and strobe light:

- 1 Disconnect and lockout power to the chiller.**
- 2 Remove the visual and audible alarms from their packaging.** (See the wiring diagrams that came with the alarms)
- 3 Remove the circular knockouts located at the lower left corner of the electrical enclosure door.**

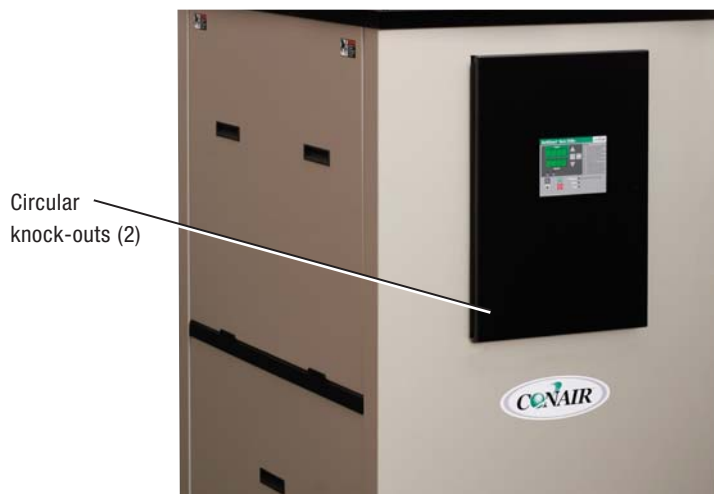

- 4 Install the visual alarm in the top knockout and the audible alarm in the bottom knockout.** (See the diagrams that came with the alarms)

Installing Alarm Indicators (optional)

(continued)

- 5** Connect the alarms to a 24VDC power source from the termination strip in the electrical enclosure. (See the wiring diagrams that came with the alarms)
Secure all wiring so that the wiring terminations are not under tension when the electrical enclosure is opened all the way.



- 6** Close the electrical enclosure and apply main power to the chiller to test the installation.

 **NOTE:** Passive alarms will not activate an alarm output from the chiller's control.



IMPORTANT: Always refer to the wiring diagrams that came with your chiller to locate specific electrical components. Illustrations in the User Guide are intended to be representative only.

Operation

SECTION

4

Basic control features	4-4
EarthSmart Chiller control functions	4-5
Control function flow charts	4-5
How to navigate the menu tree	4-5
EarthSmart Chiller menu tree	4-6
Control function descriptions	4-14
Before starting	4-40
Starting the chiller	4-41
Stopping the chiller	4-42
EarthSmart Chiller sequence of operation . .	4-43
Adjusting setpoint temperature	4-44
How to use the supervisor's password	4-45
Autotuning requirements	4-46
Autotuning procedure	4-46
Changing from fahrenheit to celsius units . .	4-49
Enabling/Disabling display decimal point for temperature	4-50
Glycol operation enable/disable	4-51
Adjusting the process variable selection . . .	4-52
Autofill enable/disable (optional)	4-53
Setting serial Modbus communication ID . . .	4-54
Adjusting serial baud rate	4-55

Operation
4

Setting alarm parameters	4-56
Adjusting the low pressure inhibit time	4-56
Adjusting the low pressure delay time.	4-58
Adjusting the flow switch alarm	
inhibit time	4-59
Adjusting the flow switch alarm delay time .	4-60
Adjusting the process high alarm setpoint . .	4-61
Adjusting the process high alarm	
inhibit time	4-62
Adjusting the process high alarm	
delay time	4-63
Adjusting the process high temperature	
shutdown setpoint	4-64
Adjusting the process high temperature	
shutdown inhibit time	4-65
Adjusting the process high temperature	
shutdown delay time	4-66
Adjusting the process low alarm setpoint . .	4-67
Adjusting the process low alarm	
inhibit time	4-68
Adjusting the process low alarm	
delay time	4-69
Adjusting the process deviation	
high alarm setpoint	4-70

Adjusting the process deviation	
low alarm setpoint	4-71
Adjusting the process deviation high	
alarm inhibit time	4-72
Adjusting the process deviation high	
alarm delay time	4-73
Adjusting the process deviation low	
shutdown alarm setpoint	4-74
Enabling/Disabling process loop break	4-75
Adjusting the process loop break timer	4-76
Adjusting the alarm silence timer	4-77
Adjusting the autofill alarm timer	4-78
Adjusting the compressor cycles per hour	
alarm setpoint	4-79
Adjusting the freeze protection shutdown	
alarm setpoint	4-80

Basic Control Features

The EarthSmart Basic Control lets you view the status of the chiller and change settings.

Scroll Button
Press to scroll through menu lists. Pressing the **“Scroll”** button moves you down the list and saves changes to individual screens.

Increment/Decrement Buttons
Used to increase (+) and/or decrease (-) the setpoint of a control function.

Function Button
Used to select different control functions in conjunction with the **“Scroll”** button or to save and escape menu trees during chiller setup.

Dual Display
Dual 4-digit LED screens shows actual and setpoint process temperatures, alpha-numeric alarm codes and operation indicators.

Acknowledge Alarm Button
Press once to silence the optional audible and visual alarms. Once the alarm condition has been satisfied, press again to clear the alarm message.

Temperature Indicator LEDs
Illuminated LEDs display the current units of measurement for temperature.

Alarm Indicator LED
When an alarm condition is detected this LED will be illuminated.

Start and Stop Buttons
Press **“Start”** to start the chiller. Press **“Stop”** to stop the chiller.

Alpha-numeric Alarm Codes
Alpha-numeric characters are displayed in the setpoint screen for both process and alarm conditions during normal operation. [See Troubleshooting section for a more complete listing of alarms.](#)

Status Indicator LEDs
Illuminated LED lights show the status of the chiller.

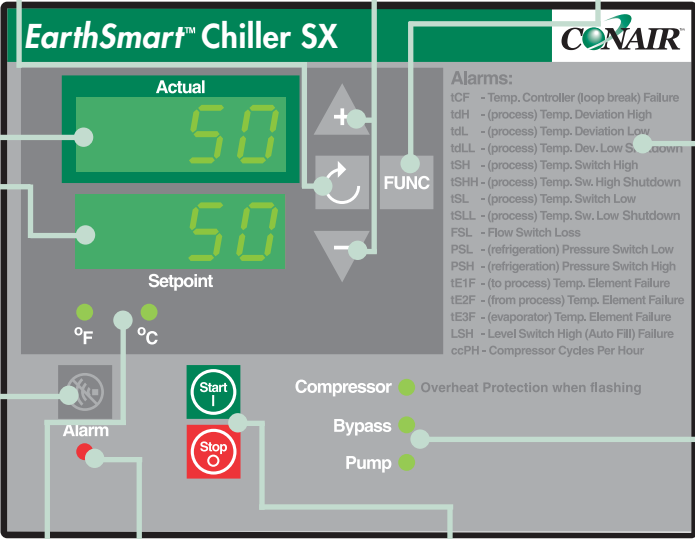

The diagram shows the EarthSmart Chiller SX control panel. It features two 4-digit LED displays: the top one shows 'Actual' temperature at 50 and the bottom one shows 'Setpoint' temperature at 50. To the right of the displays are three buttons: a '+' button, a 'FUNC' button, and a '-' button. Below the displays are two indicator LEDs for temperature units: °F (illuminated) and °C. At the bottom left is an 'Alarm' indicator LED (illuminated) and an 'Acknowledge Alarm' button. At the bottom center are 'Start' and 'Stop' buttons. At the bottom right are three status indicator LEDs for 'Compressor', 'Bypass', and 'Pump', all of which are illuminated. A 'FUNCTION' button is also present. A list of alarm codes is provided on the right side of the panel.

Alarms:

- ICF - Temp. Controller (loop break) Failure
- tdH - (process) Temp. Deviation High
- tdL - (process) Temp. Deviation Low
- tdLL - (process) Temp. Dev. Low Shutdown
- ISH - (process) Temp. Switch High
- ISHH - (process) Temp. Sw. High Shutdown
- ISL - (process) Temp. Switch Low
- ISLL - (process) Temp. Sw. Low Shutdown
- FSL - Flow Switch Loss
- PSL - (refrigeration) Pressure Switch Low
- PSH - (refrigeration) Pressure Switch High
- IE1F - (to process) Temp. Element Failure
- IE2F - (from process) Temp. Element Failure
- IE3F - (evaporator) Temp. Element Failure
- LSH - Level Switch High (Auto Fill) Failure
- cCPH - Compressor Cycles Per Hour

EarthSmart Chiller Control Functions

Chiller functions are values that you can set or monitor. Press the “**Scroll**” button to access a function within a Menu list until the parameter to be set or monitored appears in the “Actual” LED display.

 **NOTE:** Grey shaded screens denote supervisor functions. To access the supervisor screens, see *Operation section entitled, Using the Supervisor’s Password.*

Control Function Flow Charts

The charts beginning on page 4-6 provide a quick summary of the control functions. For an explanation of each control function, see *Operation section entitled, Control Function Descriptions.*

How to Navigate the Menu Tree

To scroll through the Main Status Menu, use the “**Scroll**” button. To access the Process Setup, Analog Input Setup, Alarm Setup, Running Time Status, Setup, Test Mode and Alarm History menu trees, push and release both the “**Scroll**” and “**Function**” buttons together. Once you have selected a menu tree, use the “**Scroll**” button to scroll through the screens. Press the “**Scroll**” button to save any setting changed within the selected menu. If no changes are made within a menu tree, the control will automatically return to the Main Status Menu after two (2) minutes.

 **NOTE:** Pressing the “**Function**” button within a menu tree will also save any changes and return you to the Main Menu.

 **TIP:** Pressing and holding the “**Scroll**” button while pressing the “**Function**” button will increase menu navigation speed.

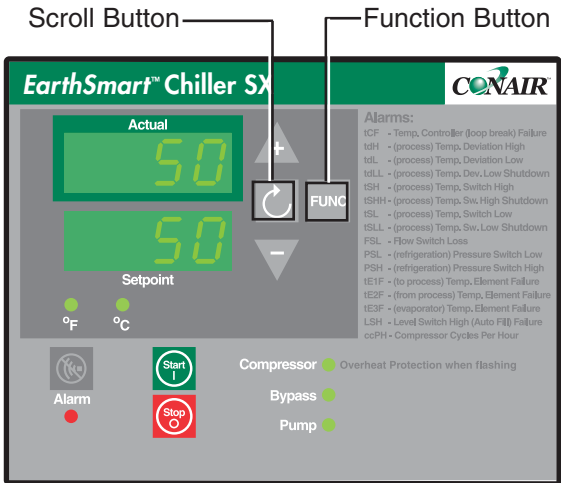

EarthSmart Chiller Menu Tree

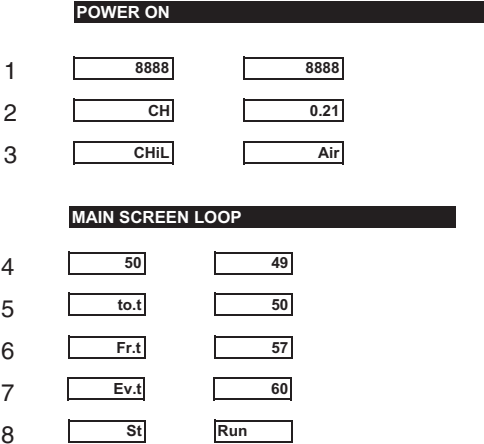

EarthSmart Chiller Menu Tree

(continued)

PROCESS SETUP - MENU BRANCH		
9	Pro	CES
10	C.L	mn
11	tun	OFF
12	Out	70
13	Pb	26.0
14	int	15.0
15	dEr	5.0
16	CYC	10
17	On.P	90
18	Hi.L	75
19	Lo.L	20
20	ra.S	off
21	ra.r	0
22	ra.H	0
23	AF.d	1
24	CCou	4
25	CCin	2

 **NOTE:** Grey shaded screens denote supervisor functions. To access the supervisor screens, *see Operation section entitled, Using the Supervisor's Password.*

EarthSmart Chiller Menu Tree

(continued)

ANALOG INPUT SETUP - MENU BRANCH

26	<input type="text" value="in"/>	<input type="text" value="Put"/>
27	<input type="text" value="CtL"/>	<input type="text" value="to"/>
28	<input type="text" value="FL.1"/>	<input type="text" value="1.0"/>
29	<input type="text" value="FL.2"/>	<input type="text" value="1.0"/>
30	<input type="text" value="FL.3"/>	<input type="text" value="1.0"/>
31	<input type="text" value="bi.1"/>	<input type="text" value="0.0"/>
32	<input type="text" value="bi.2"/>	<input type="text" value="0.0"/>
33	<input type="text" value="bi.3"/>	<input type="text" value="0.0"/>

 **NOTE:** Grey shaded screens denote supervisor functions. To access the supervisor screens, *see Operation section entitled, Using the Supervisor's Password.*

EarthSmart Chiller Menu Tree

(continued)

ALARM HISTORY- MENU BRANCH

34	<input type="text" value="AL"/>	<input type="text" value="H"/>
35	<input type="text" value="tCF"/>	<input type="text" value="HH.MM"/>
36	<input type="text" value="tSLL"/>	<input type="text" value="HH.MM"/>
37	<input type="text"/>	<input type="text" value="HH.MM"/>
38	<input type="text"/>	<input type="text" value="HH.MM"/>
39	<input type="text"/>	<input type="text" value="HH.MM"/>
40	<input type="text"/>	<input type="text" value="HH.MM"/>
41	<input type="text"/>	<input type="text" value="HH.MM"/>
42	<input type="text"/>	<input type="text" value="HH.MM"/>
43	<input type="text"/>	<input type="text" value="HH.MM"/>
44	<input type="text"/>	<input type="text" value="HH.MM"/>
45	<input type="text"/>	<input type="text" value="HH.MM"/>
46	<input type="text"/>	<input type="text" value="HH.MM"/>
47	<input type="text"/>	<input type="text" value="HH.MM"/>
48	<input type="text"/>	<input type="text" value="HH.MM"/>

EarthSmart Chiller Menu Tree

(continued)

ALARM SETUP - MENU BRANCH

49	AL	r
50	LP.l	60
51	LP.d	5
52	FL.l	10
53	FL.d	5
54	H.AL	85
55	H.Ai	10
56	H.Ad	5
57	H.SA	95
58	H.Si	300
59	H.Sd	5
60	L.AL	40
61	L.Ai	10
62	L.Ad	10
63	dE.H	5
64	dE.L	5
65	dE.l	600
66	dE.d	30
67	dL.L	80
68	Lb.e	OFF
69	Lb.t	10
70	ALS	10
71	AF.t	300
72	nccH	10
73	FP	41

 **NOTE:** Grey shaded screens denote supervisor functions. To access the supervisor screens, *see Operation section entitled, Using the Supervisor's Password.*

EarthSmart Chiller Menu Tree

(continued)

RUNNING TIME STATUS - MENU BRANCH

74	<input type="text" value="run"/>	<input type="text" value="tnn"/>
75	<input type="text" value="cPr"/>	<input type="text" value="30.0"/>
76	<input type="text" value="cPC"/>	<input type="text" value="20.0"/>
77	<input type="text" value="LLvC"/>	<input type="text" value="25.0"/>
78	<input type="text" value="HgC"/>	<input type="text" value="25.0"/>
79	<input type="text" value="PPr"/>	<input type="text" value="681.0"/>
80	<input type="text" value="PPC"/>	<input type="text" value="84.0"/>
81	<input type="text" value="Fnr"/>	<input type="text" value="111.0"/>
82	<input type="text" value="FnC"/>	<input type="text" value="42.0"/>

EarthSmart Chiller Menu Tree

(continued)

SETUP - MENU BRANCH

83	Set	uP
84	PaSS	###
85	unit	F
86	deCP	oFF
87	FiL	oFF
88	gLy	no
89	id	1
90	bAud	9600
91	C.r	oFF
92	Hg.r	oFF
93	PP.r	oFF
94	F.r	oFF
95	LL.r	oFF
96	Ld.d	oFF

 **NOTE:** Grey shaded screens denote supervisor functions. To access the supervisor screens, *see Operation section entitled, Using the Supervisor's Password.*

EarthSmart Chiller Menu Tree

(continued)

TEST- MENU BRANCH		
97	<input type="text" value="tE"/>	<input type="text" value="St"/>
98	<input type="text" value="in.1"/>	<input type="text" value="oFF"/>
99	<input type="text" value="in.2"/>	<input type="text" value="on"/>
100	<input type="text" value="in.3"/>	<input type="text" value="on"/>
101	<input type="text" value="in.4"/>	<input type="text" value="oFF"/>
102	<input type="text" value="in.5"/>	<input type="text" value="oFF"/>
103	<input type="text" value="ou.1"/>	<input type="text" value="oFF"/>
104	<input type="text" value="ou.2"/>	<input type="text" value="oFF"/>
105	<input type="text" value="ou.3"/>	<input type="text" value="oFF"/>
106	<input type="text" value="ou.4"/>	<input type="text" value="oFF"/>
107	<input type="text" value="ou.5"/>	<input type="text" value="oFF"/>
108	<input type="text" value="ou.6"/>	<input type="text" value="oFF"/>
109	<input type="text" value="ou.7"/>	<input type="text" value="oFF"/>

Screen 102 and 109 will only be shown when the optional Autofill hardware and axillary board are installed.

 **NOTE:** Grey shaded screens denote supervisor functions. To access the supervisor screens, *see Operation section entitled, Using the Supervisor's Password.*

Control Function Descriptions

Screen

SCREEN 1 (Read-only)

8.8.8.8

8.8.8.8

SCREEN 2 (Read-only)
Software Revision

CH

V1.01

SCREEN 3 (Read-only)

CHiL

Air

SCREEN 4 (Read-only)

50

Actual

49

Setpoint

Function

Once power is turned on, this screen is displayed for 2 seconds. This screen is a display test to ensure that all the segments of the LED display are functioning properly.

Once power is turned on and Screen 1 has been displayed for 2 seconds, this screen will be displayed for another 2 seconds. This screen displays the current software version of the chiller.

After Screen 1 and 2 have been displayed, this screen will be shown for an additional 2 seconds. This screen shows the designation of the type of chiller the control is operating. (Air or H2O)

This screen is the top screen of the Main Status Menu. It displays both actual and setpoint temperatures. The top screen shows the Actual temperature of the (To, From or Average) process coolant. The bottom screen shows the user-entered process temperature. Process temperature ranges are 40° - 70°F {4.4° - 21.1°C}. Once this screen is displayed, use the (+) and (-) buttons to change this setting. Holding down the (+) or (-) buttons causes this setting to ramp up or down at a faster rate.

Control Function Descriptions (continued)

Screen

SCREEN 5 (Read-only)

to.t

50

SCREEN 6 (Read-only)

Fr.t

57

SCREEN 7 (Read-only)

Ev.t

60

SCREEN 8 (Read-only)

ST

SbY

Function

This screen shows the “To Process” temperature measured by a RTD at the “To Process” outlet of the chiller.

This screen shows the “From Process” temperature measured by a RTD at the “From Process” inlet of the chiller.

This screen displays the evaporator leaving temperature.

This screen displays the chiller’s status mode: RUN, STANDBY, MANUAL, AUTOTUNE and TEST modes. *See Operation section entitled, Control Function Descriptions, Screens 10 and 11.*

Control Function Descriptions

• TIP: Pressing and holding the “Scroll” button while pressing the “Function” button will increase menu navigation speed.

 **NOTE:** Grey shaded screens denote supervisor functions. To access the supervisor screens, see *Operation section entitled, Using the Supervisor's Password.*

Screen

SCREEN 9

Pro

CES

SCREEN 10 (Read-only)

C.L

mn

SCREEN 11

tun

OFF

SCREEN 12 (Read-only)

Out

70

Function





This is the first screen of the Process Setup Menu tree. To access this screen press and release both the “Scroll” and “Function” buttons until this screen is shown on the chiller’s dual LED display.

This screen displays the status of the pump control. (MN = Manual Mode and AUTO = Automatic Mode) Manual Mode is only selectable from initial start-up or Standby Mode by pressing the “Start” button for 7 seconds. The chiller’s compressor is deactivated in Manual Mode.

This screen is the Autotune On/Off. Pressing the (+) button on this screen will turn on Autotune, pressing the (-) will turn off Autotune. The chiller will only start an Autotune when the chiller is running and has a stable load. See *Operation section entitled, Autotuning Requirements and Autotuning Procedure.*

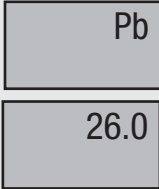
Shows the “On-time” versus “Off-time” ratio of the Hot-Gas Bypass valve during a cooling cycle. See *Operation section entitled, Control Function Descriptions, Screen 17.*

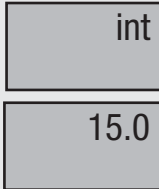
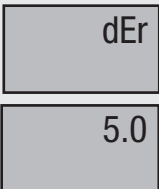
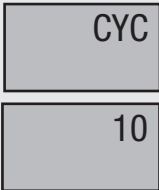
Control Function Descriptions (continued)

Screen	Function
<p>SCREEN 13</p> 	<p>This screen displays the Process Proportional Gain. This value is defined by the Autotune cycle. A higher Proportional Gain setting will cause a faster coolant temperature change, but will use more energy. A lower setting will cause a slower coolant temperature change, but requires less energy. Once this screen is displayed, use the (+) and (-) buttons to change this setting.</p> <p> NOTE: Grey shaded screens denote supervisor functions. To access the supervisor screens, see Operation section entitled, Using the Supervisor's Password.</p>
<p>SCREEN 14</p> 	<p>This is the Process Integral screen. It is used to slowly adjust the position of the proportional gain setting to eliminate offset error. Use the (+) and (-) buttons to change this setting.</p>
<p>SCREEN 15</p> 	<p>This is the Process Derivative screen. It is used to change how fast or slow the control will react to load changes. Use the (+) and (-) buttons to change this setting.</p>
<p>SCREEN 16</p> 	<p>This screen displays the duration of the Hot-gas Bypass valve cycle. Once this screen is displayed, use the (+) and (-) buttons to change this setting. Conair recommends a 5 to 10 second setting. The range of this setting is 0 to 120 seconds.</p> <p> NOTE: A cycle includes the amount of on time and off time. For example, a 10 second cycle time equals 5 seconds on and 5 seconds off of the Hot-gas Bypass valve.</p>

Control Function Descriptions



NOTE: Grey shaded screens denote supervisor functions. To access the supervisor screens, see *Operation section entitled, Using the Supervisor's Password.*



NOTE: Settings for Screens 18 and 19 can **not** overlap.



WARNING: To operate below 40°F {4.4°C}, you must use an industrial glycol mixture and activate glycol usage within the chiller control. See *Operation section entitled, Glycol Usage Enable/Disable.*

Screen

SCREEN 17

On.P

90

SCREEN 18

Hi.L

75

SCREEN 19

Lo.L

20

SCREEN 20

ra.S

OFF

Function

This screen displays the total allowable output of the Hot-gas Bypass valve during one cycle. Once this screen is displayed, use the (+) and (-) buttons to change this setting. The range is 0 to 90 percent.



WARNING: Changing this setting will effect chiller performance.

This screen displays the Process Setpoint High Limit. This screen sets the maximum temperature setpoint of the chiller. Once this screen is displayed, use the (+) and (-) buttons to change this setting. The range is 20° to 70°F {-6.7° to 21.1°C}.

This screen displays the Process Setpoint Low Limit. This screen sets the minimum temperature setpoint of the chiller. Once this screen is displayed, use the (+) and (-) buttons to change this setting. The range is 20° to 70°F {-6.7° to 21.1°C}.

This screen displays the Ramp-to Setpoint On/Off. Turning on this setting will allow temperature ramping to setpoint by the rate set on Screen 21. Pressing the (+) button on this screen will turn on the Ramp-to Setpoint, pressing the (-) will turn off the Ramp-to Setpoint.

Control Function Descriptions (continued)

Screen

SCREEN 21

ra.r

0

SCREEN 22

ra.H

0

SCREEN 23

AF.d

1

Function

This screen displays the Ramp-to Rate. When pressing the (+) or (-) buttons to change the temperature rate at which the process temperature will achieve setpoint temperature. Use the (+) or (-) buttons to change this setting. The range is 0° to 120°F {0° to 67.4°C} degrees per minute.

This screen displays the Ramp-to Setpoint Hold Back Band. This setting is used to allow the temperature ramp setting (Screen 21) to achieve a linear temperature profile by allowing a wider temperature delta. Once this screen is displayed, use the (+) and (-) buttons to change this setting. The range is 0° to 50°F {0° to 28.1°C}.

This screen displays the Autofill Deadband Delay when the Autofill option is included. Autofill automatically fills the chiller's internal reservoir. A normally-open circuit float switch that must be installed inside the reservoir indicates to the control that it is full. *See Appendix G entitled, Installing Autofill (optional).* When the float switch circuit closes it stops the flow of coolant. This setting delays the shutoff signal and “overfills” the reservoir to eliminate float switch “bobbing” that can trigger an alarm condition. On this screen, use the (+) or (-) buttons to change this setting. The range is 0 to 60 seconds.



NOTE: Grey shaded screens denote supervisor functions. To access the supervisor screens, *see Operation section entitled, Using the Supervisor's Password.*

Control Function Descriptions



NOTE: Grey shaded screens denote supervisor functions. To access the supervisor screens, see *Operation section entitled, Using the Supervisor's Password.*



NOTE: Conair recommends the range between the Compressor Cut-in and Cut-out Deviation Setpoint should be not less than 6°F {3.3°C}. This will eliminate short-cycling of the compressor under light loads and increases the life of the compressor.

Screen

SCREEN 24

CCou

4

SCREEN 25

CCin

2

Function

This screen displays the Compressor Cut-out Deviation Setpoint. This is the temperature deviation below the user-entered setpoint that will cause the chiller's compressor to shut off. Use the (+) or (-) buttons to change this setting. The range is 1° to 10°F {0.5° to 5.6°C}.

This screen displays the Compressor Cut-in Deviation Setpoint. This is the temperature deviation above the user-entered setpoint that will cause the chiller's compressor to turn on. Use the (+) or (-) buttons to change this setting. The range is 0° to 5°F {0° to 2.8°C}.

Control Function Descriptions

Screen
<p>SCREEN 26</p> <div style="border: 1px solid black; padding: 2px; margin-bottom: 5px; text-align: center;">In</div> <div style="border: 1px solid black; padding: 2px; margin-bottom: 5px; text-align: center;">Put</div>
<p>SCREEN 27</p> <div style="border: 1px solid black; padding: 2px; margin-bottom: 5px; text-align: center;">CtL</div> <div style="border: 1px solid black; padding: 2px; margin-bottom: 5px; text-align: center;">to</div>
<p>SCREEN 28</p> <div style="border: 1px solid black; padding: 2px; margin-bottom: 5px; text-align: center; background-color: #cccccc;">FL.1</div> <div style="border: 1px solid black; padding: 2px; margin-bottom: 5px; text-align: center; background-color: #cccccc;">1.0</div>
<p>SCREEN 29</p> <div style="border: 1px solid black; padding: 2px; margin-bottom: 5px; text-align: center; background-color: #cccccc;">FL.2</div> <div style="border: 1px solid black; padding: 2px; margin-bottom: 5px; text-align: center; background-color: #cccccc;">1.0</div>

Function

This is the first screen of the Input Menu tree. To access this screen press and release both the **“Scroll”** and **“Function”** buttons until this screen is shown on the chiller’s dual LED display.

 **TIP:** Pressing and holding the **“Scroll”** button while pressing the **“Function”** button will increase menu navigation speed.

This screen displays the Process Control Input. This screen dictates where the chiller will read its actual temperature. (“To Process”, “From Process” or an “Average” of the two values) Use the (+) and (-) buttons to choose between the settings.

 **NOTE:** Grey shaded screens denote supervisor functions. To access the supervisor screens, see [Operation section entitled, Using the Supervisor’s Password.](#)

This screen displays the time period the chiller’s control will sample the “To Process” temperature. A long time duration between samples will allow for temperature jumps, a low duration will help accuracy, but may trigger alarms due to temperature fluctuations. Use the (+) and (-) buttons to change this setting. The range is 0.1 to 10 seconds.

This screen displays the time period the chiller’s control will sample the “From Process” temperature. A long time duration between samples will allow for temperature jumps, a low duration will help accuracy, but may trigger alarms due to temperature fluctuations. Use the (+) and (-) buttons to change this setting. The range is 0.1 to 10 seconds.

Control Function Descriptions (continued)



NOTE: Grey shaded screens denote supervisor functions. To access the supervisor screens, see *Operation section entitled, Using the Supervisor's Password.*



NOTE: Temperature offsets are only to be used in the event the RTD temperature does not match your actual temperature.

Screen

SCREEN 30

FL.3

1.0

SCREEN 31

bi.1

0.0

SCREEN 32

bi.2

0.0

SCREEN 33

bi.3

0.0

Function

This screen displays the time period the chiller's control will sample the "Average" temperature. A long time duration between samples will allow for temperature jumps, a low duration will help accuracy, but may trigger alarms due to temperature fluctuations. Use the (+) and (-) buttons to change this setting. The range is 0.1 to 10 seconds.

This screen displays the "To Process" Temperature Gain Offset. This setting is used to compensate for the temperature resistance of the "To Process" RTD connection. Use the (+) and (-) buttons to change this setting. The range is -1000° to 1000°F {-555.6° to 555.6°C}.

This screen displays the "From Process" Temperature Gain Offset. This setting is used to compensate for the temperature resistance of the "From Process" RTD connection. Use the (+) and (-) buttons to change this setting. The range is -1000° to 1000°F {-555.6° to 555.6°C}.

This screen displays the "Average" Temperature Gain Offset. This setting is used to compensate for the temperature resistance of the "Average" RTD connection from the chiller's evaporator. Use the (+) and (-) buttons to change this setting. The range is -1000° to 1000°F {-555.6° to 555.6°C}.

Control Function Descriptions

Screen

SCREEN 34

AL
H

SCREEN 35 (Read-only)

tCF
HH.MM

SCREEN 36 (Read-only)

tSLL
HH.MM

SCREEN 37-48 (Read-only)

HH.MM

Function

This is the first screen of the Alarm History Menu tree. To access this screen press and release both the “**Scroll**” and “**Function**” buttons until this screen is shown on the chiller’s dual LED display.

This is a sample of an alarm screen. During an alarm condition, the alphanumeric alarm code will be shown in the chiller’s upper “Actual” display. The time the alarm occurred will be shown in the lower “Setpoint” display. *See Troubleshooting section for alarm condition descriptions.*

This is another sample of an alarm screen. During an alarm condition, the alphanumeric alarm code will be shown in the chiller’s upper “Actual” display. The time the alarm occurred will be shown in the lower “Setpoint” display. *See Troubleshooting section for alarm condition descriptions.*

The chiller’s control will record and store up to 40 alarms with time stamping. Once 40 alarms have been accumulated, the alarms will be stored in a first-in, first-out basis. *See Troubleshooting section for alarm condition descriptions.*

•➡ **TIP:** Pressing and holding the “**Scroll**” button while pressing the “**Function**” button will increase menu navigation speed.

 **NOTE:** The control will also flash the number of power cycles since first power up until the alarm condition has occurred.

Control Function Descriptions

➡ **TIP:** Pressing and holding the “**Scroll**” button while pressing the “**Function**” button will increase menu navigation speed.

 **NOTE:** Grey shaded screens denote supervisor functions. To access the supervisor screens, see [Operation section entitled, Using the Supervisor's Password.](#)

Screen

SCREEN 49

AL

R

SCREEN 50

LP.i

60

SCREEN 51

LP.d

5

SCREEN 52

FL.i

10

Function

This is the first screen of the Alarm Setup Menu tree. To access this screen press and release both the “**Scroll**” and “**Function**” buttons until this screen is shown on the chiller’s dual LED display.

This screen displays the Low Pressure Inhibit Time. This setting is used to adjust the amount of time after chiller start-up the Low Pressure Alarm input will be ignored. This is used so that the chiller can generate enough coolant pressure to begin normal operation. Use the (+) and (-) buttons to change this setting. The range is 0 to 120 seconds.

This screen displays the Low Pressure Delay Time. This setting is used to adjust the amount of time after the chiller has detected a Low Pressure Alarm, that its input will be ignored. This is used to prevent nuisance alarms during Hot-gas Bypass valve cycling. Use the (+) and (-) buttons to change this setting. The range is 0 to 30 seconds.

This screen displays the Flow Switch Alarm Inhibit Time. This setting is used to adjust the amount of time after chiller start-up the Flow Switch Alarm input will be ignored. This is used so that the chiller can begin to flow coolant. Use the (+) and (-) buttons to change this setting. The range is 0 to 60 seconds.

Control Function Descriptions (continued)

Screen	Function
<p>SCREEN 53</p> <p>FL.d</p> <p>5</p>	<p>This screen displays the Flow Switch Alarm Delay Time. This setting is used to adjust the amount of time after the chiller has detected a Flow Switch Alarm, that the input will be ignored. Use the (+) and (-) buttons to change this setting. The range is 0 to 30 seconds.</p>
<p>SCREEN 54</p> <p>H.AL</p> <p>85</p>	<p>This screen displays the Process High Alarm setpoint. This setting is used to activate a Process High Alarm when the chiller's process control input (Screen 27) coolant temperature exceeds the user-entered coolant temperature set at this screen. This is used to alert the operator to possible temperature fluctuations that can effect end product. Use the (+) and (-) buttons to change this setting. The range is 0° to 85°F {-17.8° to 29.4°C}.</p>
<p>SCREEN 55</p> <p>H.Ai</p> <p>10</p>	<p>This screen displays the Process High Alarm Inhibit Time. This setting is used to adjust the amount of time after chiller start-up the Process High Alarm input will be ignored. This is used so that the chiller can lower the temperature of the coolant below the temperature set at Screen 54. Use the (+) and (-) buttons to change this setting. The range is 0 to 300 seconds.</p>
<p>SCREEN 56</p> <p>H.Ad</p> <p>5</p>	<p>This screen displays the Process High Alarm Delay Time. This setting is used to adjust the amount of time after the chiller has detected a Process High Alarm, that its input will be ignored. This is used to eliminate nuisance alarms during startup or operation. Use the (+) and (-) buttons to change this setting. The range is 0 to 60 seconds.</p>

 **NOTE:** Grey shaded screens denote supervisor functions. To access the supervisor screens, see *Operation section entitled, Using the Supervisor's Password.*

Control Function Descriptions



NOTE: Grey shaded screens denote supervisor functions. To access the supervisor screens, see *Operation section entitled, Using the Supervisor's Password.*

Screen

Function

SCREEN 57

H.SA

95

This screen displays the Process High Temperature Shutdown Setpoint. This setting is used to shut down the chiller when the “To Process” coolant temperature exceeds the user-entered maximum coolant temperature set at this screen. This is used to prevent any damage to the chiller or end product. Use the (+) and (-) buttons to change this setting. The range is 50° to 100°F {10° to 37.8°C}.

SCREEN 58

H.Si

300

This screen displays the Process High Temperature Shutdown Inhibit Time. This setting is used to adjust the amount of time after chiller start-up the Process High Temperature Shutdown input will be ignored. This is used so that the chiller can lower the process temperature to normal operating conditions. Use the (+) and (-) buttons to change this setting. The range is 0 to 900 seconds.

SCREEN 59

H.Sd

5

This screen displays the Process High Temperature Shutdown Delay Time. This setting is used to adjust the amount of time after the chiller has detected a Process High Shutdown, that its input will be ignored. This is used to eliminate nuisance alarms during startup or operation. Use the (+) and (-) buttons to change this setting. The range is 0 to 60 seconds.



SCREEN 60 (Freeze prevention)

L.AL

40

This screen displays the Process Low Alarm Setpoint. This setting is used to activate a Process Low Alarm when the chiller’s process control input (Screen 27) temperature falls below the user-entered minimum coolant temperature set at this screen. This is used to prevent any damage to the chiller or end product. Use the (+) and (-) buttons to change this setting. The range is 35° to 50°F {-1.7° to 10°C} or if a glycol mixture is used 15° to 50°F {-9.4° to 10°C}.

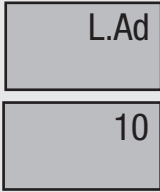
Control Function Descriptions (continued)

Screen	Function
SCREEN 61  SCREEN 61 displays two fields: the top field contains 'L.Ai' and the bottom field contains '10'.	This screen displays the Process Low Alarm Inhibit Time. This setting is used to adjust the amount of time after chiller start-up the Process Low Alarm input will be ignored. This is used so that the chiller can raise the temperature of the coolant above the temperature set at Screen 60. Use the (+) and (-) buttons to change this setting. The range is 0 to 180 seconds.
SCREEN 62  SCREEN 62 displays two fields: the top field contains 'L.Ad' and the bottom field contains '10'.	This screen displays the Process Low Alarm Delay Time. This setting is used to adjust the amount of time after the chiller has detected a Process Low Alarm, that its input will be ignored. This is used to eliminate nuisance alarms. Use the (+) and (-) buttons to change this setting. The range is 0 to 180 seconds.
SCREEN 63  SCREEN 63 displays two fields: the top field contains 'dE.H' and the bottom field contains '5'.	This screen displays the Process Deviation High Alarm Setpoint. This setting is used to activate a Process Deviation High Alarm when the chiller's process control input (Screen 27) coolant temperature exceeds the user-entered coolant temperature by the amount set at this screen. This is used to alert the operator to possible temperature fluctuations that can effect end product. Use the (+) and (-) buttons to change this setting. The range is 0° to 25°F {0° to 14°C}.
Screen 64  Screen 64 displays two fields: the top field contains 'dE.L' and the bottom field contains '5'.	This screen displays the Process Deviation Low Alarm Setpoint. This setting is used to activate a Process Low Alarm when the chiller's process control input (Screen 27) coolant temperature falls below the user-entered coolant temperature by the amount set at this screen. This is used to alert the operator to possible temperature fluctuations that can effect end product. Use the (+) and (-) buttons to change this setting. The range is 0° to 25°F {0° to 14°C}.



NOTE: Grey shaded screens denote supervisor functions. To access the supervisor screens, see [Operation section entitled, Using the Supervisor's Password.](#)

Control Function Descriptions



NOTE: Grey shaded screens denote supervisor functions. To access the supervisor screens, see *Operation section entitled, Using the Supervisor's Password.*

Screen

SCREEN 65

dE.i

600

SCREEN 66

dE.d

30

SCREEN 67

dL.L

80

SCREEN 68

Lb.e

OFF

Function

This screen displays the Process Deviation High Alarm Inhibit Time. This setting is used to adjust the amount of time after chiller start-up that the Process High Alarm input will be ignored. This is used so that the chiller can reduce the temperature of the coolant to within the temperature range set at Screen 63. Use the (+) and (-) buttons to change this setting. The range is 0 to 900 seconds.

This screen displays the Process Deviation High Alarm Delay Time. This setting is used to adjust the amount of time after the chiller has detected a Process Deviation High Alarm, that its input will be ignored. This is used so that the chiller's temperature can resume normal operating conditions. Use the (+) and (-) buttons to change this setting. The range is 0 to 900 seconds.

This screen displays the Process Deviation Low Shutdown Alarm Setpoint. This setting is the maximum deviation below the user-entered low temperature setpoint, Screen 19. When the coolant falls below the setpoint by the amount set at this screen, the chiller automatically shuts down to avoid freeze damage to the evaporator or process material. Use the (+) and (-) buttons to change this setting. The range is 0° to 80°F {0° to 44.9°C}.

This screen displays the Process Loop Break On/Off. This setting can be used when the process temperature is higher or lower than the actual temperature setpoint, but never exceeds the Process Deviation High or Low setpoints. When enabled, this setting will activate a Process Loop Break Alarm. This setting will always be deactivated when the Ramp-to setting has been enabled. Use the (+) and (-) buttons to turn this setting on or off.

Control Function Descriptions (continued)

Screen	Function
<p>SCREEN 69</p> <p>Lb.t</p> <p>10</p>	<p>This screen displays the Process Loop Break Time. This setting is used to adjust the amount of time the Process Loop Break will wait before alarming. (Screen 68). However, if the actual temperature reaches the setpoint temperature. The timer on the delay time will reset. Use the (+) and (-) buttons to change this setting. The range is 0 to 900 seconds.</p>
<p>SCREEN 70 (optional)</p> <p>ALS</p> <p>10</p>	<p>This screen displays the Alarm Silence Timer. This setting is used to adjust the amount of time after the “Alarm Acknowledgement” button has been pressed that the optional beacon and visual alarms will be de-activated. However, if the alarm condition has not been satisfied the optional beacon and visual alarms will be re-activated. Use the (+) and (-) buttons to change this setting. The range is 0 to 120 minutes.</p>
<p>SCREEN 71 (optional)</p> <p>AF.t</p> <p>300</p>	<p>This screen displays the Autofill Alarm Timer. This setting is used to adjust the amount of time after the control does not receive an input signal from the chiller’s reservoir float switch before signaling an alarm and shutting off Autofill. Use the (+) and (-) buttons to change this setting. The range is 0 to 900 seconds.</p>
<p>SCREEN 72</p> <p>nCCH</p> <p>10</p>	<p>This screen displays the Compressor Cycles Per Hour Alarm Point. This setting is used to adjust the number of compressor on/off cycles, per hour, in which the control will allow before activating a shutdown alarm. If the number of compressor On/Off cycles exceeds this setting, the chiller will shutdown. Use the (+) and (-) buttons to change this setting. The range is 2 to 15 cycles/hour.</p>

 **NOTE:** Grey shaded screens denote supervisor functions. To access the supervisor screens, see *Operation section entitled, Using the Supervisor’s Password.*

Control Function Descriptions

Screen

SCREEN 73

FP

41

Function

This screen displays the Freeze Protection Shutdown Alarm Setpoint. This setting is the minimum low temperature setpoint before the chiller will immediately shut down to avoid freezing of the process fluid. Use the (+) and (-) buttons to change this setting. The range is 35° to 50°F {1.7° to 10°C} or if a glycol mixture is used, 15° to 50°F {-9.4° to 10°C}.

Control Function Descriptions

Screen

SCREEN 74

run

tnn

SCREEN 75 (Read-only)

cPr

30.0

SCREEN 76 (Read-only)

cPC

20.0

SCREEN 77 (Read-only)

LLvC

25.0

Function

This is the first screen of the Running Time Status Menu tree. To access this screen press and release both the “**Scroll**” and “**Function**” buttons until this screen is shown on the chiller’s dual LED display.

➡ **TIP:** Pressing and holding the “**Scroll**” button while pressing the “**Function**” button will increase menu navigation speed.

This screen displays the total run time (hours x 100) of the compressor.

This screen displays the total number of cycles (cycles x 100) of the compressor.

This screen displays the total number of cycles (cycles x 100) of the Liquid Line Solenoid valve (LLSV).

Control Function Descriptions (continued)

Screen	Function
SCREEN 78 (Read-only) <div style="border: 1px solid black; padding: 2px; width: fit-content; margin: 2px auto;">HgC</div> <div style="border: 1px solid black; padding: 2px; width: fit-content; margin: 2px auto;">25.0</div>	This screen displays the total number of cycles (cycles x 100) of the Hot-Gas Bypass valve (HGBP).
SCREEN 79 (Read-only) <div style="border: 1px solid black; padding: 2px; width: fit-content; margin: 2px auto;">PPr</div> <div style="border: 1px solid black; padding: 2px; width: fit-content; margin: 2px auto;">681.0</div>	This screen displays the total run time (hours x 100) of the process pump.
SCREEN 80 (Read-only) <div style="border: 1px solid black; padding: 2px; width: fit-content; margin: 2px auto;">PPC</div> <div style="border: 1px solid black; padding: 2px; width: fit-content; margin: 2px auto;">84.0</div>	This screen displays the total number of cycles (cycles x 100) of the process pump.
SCREEN 81 (Read-only) <div style="border: 1px solid black; padding: 2px; width: fit-content; margin: 2px auto;">Fnr</div> <div style="border: 1px solid black; padding: 2px; width: fit-content; margin: 2px auto;">111.0</div>	This screen displays the total run time (hours x 100) of the fan. (Air-cooled only)
SCREEN 82 (Read-only) <div style="border: 1px solid black; padding: 2px; width: fit-content; margin: 2px auto;">FnC</div> <div style="border: 1px solid black; padding: 2px; width: fit-content; margin: 2px auto;">42.0</div>	This screen displays the total number of cycles (cycles x 100) of the fan. (Air-cooled only)

Control Function Descriptions

Screen
<p>SCREEN 83</p> <div style="border: 1px solid black; padding: 5px; margin-bottom: 5px; text-align: center;">Set</div> <div style="border: 1px solid black; padding: 5px; margin-bottom: 5px; text-align: center;">uP</div>
<p>SCREEN 84</p> <div style="border: 1px solid black; padding: 5px; margin-bottom: 5px; text-align: center;">PaSS</div> <div style="border: 1px solid black; padding: 5px; margin-bottom: 5px; text-align: center;">210</div>
<p>SCREEN 85</p> <div style="border: 1px solid black; padding: 5px; margin-bottom: 5px; text-align: center; background-color: #cccccc;">unit</div> <div style="border: 1px solid black; padding: 5px; margin-bottom: 5px; text-align: center; background-color: #cccccc;">F</div>
<p>SCREEN 86</p> <div style="border: 1px solid black; padding: 5px; margin-bottom: 5px; text-align: center; background-color: #cccccc;">deCP</div> <div style="border: 1px solid black; padding: 5px; margin-bottom: 5px; text-align: center; background-color: #cccccc;">oFF</div>

Function

This is the first screen of the Setup Menu tree. To access this screen press and release both the “Scroll” and “Function” buttons until this screen is shown on the chiller’s dual LED display.

TIP: Pressing and holding the “Scroll” button while pressing the “Function” button will increase menu navigation speed.

This screen displays the Supervisor’s Password. This setting is used to gain access to supervisor screens within the control. Use the (+) and (-) buttons to enter the password. The supervisor password is 210. *See Operation section entitled, Using the Supervisor’s Password.*

NOTE: Grey shaded screens denote supervisor functions. To access the supervisor screens, *see Operation section entitled, Using the Supervisor’s Password.*

This screen displays the Units Selection. This setting is used to change the chiller’s temperature readout to either Fahrenheit or Celsius. Use the (+) and (-) buttons to toggle between the two selections. A corresponding LED on the control panel will illuminate under the current selection. *See Operation section entitled, Changing from Fahrenheit to Celsius Units.*

This screen displays the Decimal Display Point for Temperature. This setting is used to include the decimal point reading for temperature. Use the (+) and (-) buttons to toggle between “on” or “off”. *See Operation section entitled, Enabling/Disabling Display Decimal Point for Temperature Display.*

Control Function Descriptions (continued)



NOTE: Grey shaded screens denote supervisor functions. To access the supervisor screens, see *Operation section entitled, Using the Supervisor's Password.*



NOTE: Ethernet communications will require configuration through the ethernet control software.

Screen

SCREEN 87

FiL

oFF

SCREEN 88

gLy

no

SCREEN 89

id

1

SCREEN 90

bAud

9600

Function

This screen displays the optional AutoFill feature “On” or “Off”. Use the (+) and (-) buttons to toggle between “on” or “off”. (Additional hardware must be installed for this feature to be activated. *See Appendix G entitled, Installing Autofill (optional).*)

This screen displays the Glycol Enable/Disable screen. Use the (+) and (-) buttons to toggle between “yes” or “no”. *See Operation section entitled, Glycol Operation Enable/Disable.*

This screen displays the Communication ID. This is used to label where the chiller will be on a Modbus network. Use the (+) and (-) buttons to select the Modbus address. The range is 1 to 247. *See Operation section entitled, Setting Serial Modbus Communication ID.*

This screen displays the Baud Rate. The Baud Rate can be changed to 2400, 4800, 9600 and 19200 according to your particular communications setup. Use the (+) and (-) buttons to select the Baud Rate. *See Operation section entitled, Adjusting Baud Rate.*

Control Function Descriptions

Screen

SCREEN 91

C.r

oFF

SCREEN 92

Hg.r

oFF

SCREEN 93

PP.r

oFF

SCREEN 94

F.r

oFF

Function

This screen displays the Compressor Cycle Count Reset. This setting is used to clear the cycle count on screen 76 when replacing the motor starter of the compressor. Use the (+) and (-) buttons to reset the compressor cycle count.



NOTE: Grey shaded screens denote supervisor functions. To access the supervisor screens, see [Operation section entitled, Using the Supervisor's Password.](#)

This screen displays the Hot-gas Bypass Valve Cycle Count Reset. This setting is used to clear the cycle count on screen 78 when replacing the Hot-gas Bypass valve. Use the (+) and (-) buttons to reset the Hot-gas Bypass valve cycle count.

This screen displays the Process Pump Cycle Count Reset. This setting is used to clear the cycle count on screen 80 when replacing the process pump. Use the (+) and (-) buttons to reset the process pump cycle count.

This screen displays the Fan Cycle Count Reset. This setting is used to clear the cycle count on screen 82 when replacing the fan. Use the (+) and (-) buttons to reset the fan cycle count.

Control Function Descriptions (continued)

Screen

SCREEN 95

LL.r

oFF

SCREEN 96

Ld.d

oFF

Function

This screen displays the Liquid Line Solenoid Valve Cycle Count Reset. This setting is used to clear the cycle count on screen 77 when replacing the Liquid Line Solenoid valve (LLSV). Use the (+) and (-) buttons to reset the liquid line solenoid valve cycle count.

This screen displays the Load Default. This setting is used to load all default settings within the Setup Menu Branch except: run times, PID values, cycle counters, controller option type, chiller type, Autofill option and Hot-gas Bypass valve present. Use the (+) and (-) buttons to reset the load defaults. *See Maintenance section entitled, Reloading Factory Default Parameters.*

Control Function Descriptions





Screen	Function
<p>SCREEN 97</p> <div style="border: 1px solid black; padding: 2px; width: fit-content; margin-bottom: 5px;">tE</div> <div style="border: 1px solid black; padding: 2px; width: fit-content;">St</div>	<p>This is the first screen of the Test Menu tree. To access this screen press and release both the “Scroll” and “Function” buttons until this screen is shown on the chiller’s dual LED display.</p>
<p>SCREEN 98 (Read-only)</p> <div style="border: 1px solid black; padding: 2px; width: fit-content; margin-bottom: 5px;">in.1</div> <div style="border: 1px solid black; padding: 2px; width: fit-content;">oFF</div>	<p>This screen displays the status of the Flow Switch. This switch is normally-open and closes when water is flowing. (On = water flow, Off = no water flow)</p>
<p>SCREEN 99 (Read-only)</p> <div style="border: 1px solid black; padding: 2px; width: fit-content; margin-bottom: 5px;">in.2</div> <div style="border: 1px solid black; padding: 2px; width: fit-content;">on</div>	<p>This screen displays the status of the High Refrigerant Pressure Switch. This switch is normally-closed and opens when high pressure (550 PSI {37.9 bar}) is reached from the compressor during a High Pressure Alarm. (On = no high pressure, Off = high pressure)</p>
<p>SCREEN 100 (Read-only)</p> <div style="border: 1px solid black; padding: 2px; width: fit-content; margin-bottom: 5px;">in.3</div> <div style="border: 1px solid black; padding: 2px; width: fit-content;">on</div>	<p>This screen displays the status of the Low Refrigerant Pressure Switch. This switch is normally-closed and opens when low pressure (110 PSI {7.6 bar}) is reached from the compressor during a Low Pressure Alarm. (On = no low pressure, Off = low pressure)</p>
<p>SCREEN 101 (Read-only)</p> <div style="border: 1px solid black; padding: 2px; width: fit-content; margin-bottom: 5px;">in.4</div> <div style="border: 1px solid black; padding: 2px; width: fit-content;">oFF</div>	<p>This screen displays the status of the Fan Cycling Pressure Switch that enables the fan on top of an air-cooled chiller to activate depending on the pressure at the outlet of the condenser. This switch is normally-open and closes when pressure at the outlet of the compressor is above 450 PSI {31.0 bar}. (On = fan on, Off = fan off when below 320 PSI {22.1 bar})</p>

➡ **TIP:** Pressing and holding the “Scroll” button while pressing the “Function” button will increase menu navigation speed.

 **NOTE:** Grey shaded screens denote supervisor functions. To access the supervisor screens, see [Operation section entitled, Using the Supervisor’s Password.](#)

 **WARNING:** Only a qualified electrical technician, trained in the use of this equipment and in avoiding exposure to voltage hazards, should perform procedures that require access to the chiller while power is on.

Control Function Descriptions (continued)

Screen	Function
<p> NOTE: Screen 102 will only be shown when the optional Autofill hardware and axillary board are installed.</p>	<p>SCREEN 102 (Read-only)</p> <div style="border: 1px solid black; padding: 5px; margin-bottom: 5px; text-align: center;">in.5</div> <div style="border: 1px solid black; padding: 5px; text-align: center;">oFF</div> <p>This screen displays the status of the optional Autofill Switch (float valve) that enables the chiller to automatically fill its internal reservoir. This switch is normally open and closes when the reservoir is filled to its capacity. (On = filled to capacity, Off = no water/filling)</p>
<p> NOTE: Grey shaded screens denote supervisor functions. To access the supervisor screens, see Operation section entitled, Using the Supervisor's Password.</p>	<p>SCREEN 103</p> <div style="border: 1px solid black; padding: 5px; margin-bottom: 5px; background-color: #cccccc; text-align: center;">ou.1</div> <div style="border: 1px solid black; padding: 5px; background-color: #cccccc; text-align: center;">oFF</div> <p>This screen tests the functionality of the Hot-Gas Bypass valve (HGBP). Use the (+) or (-) buttons to test the valve. The (+) button will open the valve and keep it open until the (-) button is pressed.</p>
<p> NOTE: The chiller must be in Standby mode to test outputs. To access Standby mode, press the "Stop" button on the control panel during normal operation.</p>	<p>SCREEN 104</p> <div style="border: 1px solid black; padding: 5px; margin-bottom: 5px; background-color: #cccccc; text-align: center;">ou.2</div> <div style="border: 1px solid black; padding: 5px; background-color: #cccccc; text-align: center;">OFF</div> <p>This screen tests the functionality of the process water pump. Use the (+) or (-) buttons to test the pump. The (+) button will turn on the pump and keep it on until the (-) button is pressed.</p>
	<p>SCREEN 105</p> <div style="border: 1px solid black; padding: 5px; margin-bottom: 5px; background-color: #cccccc; text-align: center;">ou.3</div> <div style="border: 1px solid black; padding: 5px; background-color: #cccccc; text-align: center;">oFF</div> <p>This screen tests the functionality of the compressor. Use the (+) or (-) buttons to test the compressor. The (+) button will activate the compressor and keep it on until the (-) button is pressed.</p> <p> WARNING: Only qualified technicians with proper training should test this function. (No alarm conditions or guaranteed off timer.)</p>

Control Function Descriptions (continued)

Screen

Function

SCREEN 106 (Air-cooled Only)

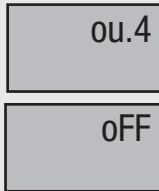

This screen tests the functionality of the fan motor. Use the (+) or (-) buttons to test the fan. The (+) button will activate the fan and keep it on until the (-) button is pressed.

 **NOTE:** Grey shaded screens denote supervisor functions. To access the supervisor screens, see [Operation section entitled, Using the Supervisor's Password.](#)

SCREEN 107 (Optional)

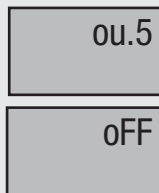

This screen tests the functionality of the Liquid Line Solenoid valve (LLSV). The liquid line solenoid valve isolates the high and low sides of the compressor. Use the (+) or (-) buttons to test the valve. The (+) button will open the two halves of the compressor and will leave them open until the (-) button is pressed.

 **NOTE:** The chiller must be in Standby mode to test outputs. To access Standby mode, press the "Stop" button on the control panel during normal operation.

SCREEN 108 (Optional)

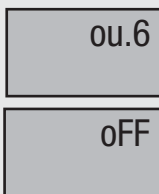

This screen tests the functionality of the optional audible and visual alarm indicators. Use the (+) or (-) buttons to test the alarm indicators. The (+) button activates the alarm indicators and will leave them on until the (-) button is pressed.

SCREEN 109 (Optional)

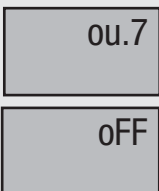

This screen tests the functionality of the Autofill operation. Use the (+) or (-) buttons to test Autofill. The (+) button will allow water to flow into the chiller's reservoir and will leave it flowing until the (-) button is pressed.

 **NOTE:** Screen 109 will only be shown when the optional Autofill hardware and axillary board are installed.

Before Starting

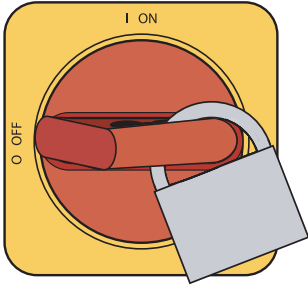

Before you start daily operation of the chiller, you need to perform scheduled preventative maintenance. *See Maintenance section entitled, Preventative Maintenance Schedule.*



WARNING: Electrical Hazard

Before performing any work on this item, disconnect and/or lock out electrical power sources to prevent injury from unexpected energization or startup.

Daily maintenance includes:

- Checking electrical connections
- Checking process fluid level in the pump tank
- Checking the condenser coil for debris (air-cooled only) or “Y” Strainer (water-cooled)
- Verifying pump discharge pressure
- Inspect piping for leaks and to ensure all valves are open.

Before starting the chiller be sure to:

- **Open the “To Process” valve (factory optional)** to the full open position.
- **Open the “From Process” valve (factory optional)** to the 3/4 open position. You will need to adjust this valve when the chiller is running to obtain the desired pump discharge pressure. To find the approximate water flow, *see Description section entitled, Pump Curves.*
- **Open the supply valve** if the chiller has the optional Autofill function.



NOTE: All panels must be in place before starting an air-cooled chiller.

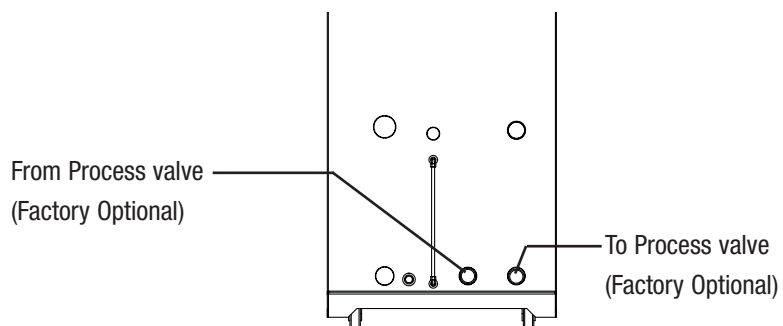



Starting the Chiller

- 1 Make sure the “To Process” valve is in the fully open position and the “From Process” valve is in the 3/4 open position.**
- 2 Turn on the main power to the chiller.** Ensure that the chiller’s optional disconnect dial is in the ON position. This powers up the control and the display lights will illuminate.
- 3 Press the START button.** 

If everything is installed correctly:

- The pump LED will illuminate.
- Compressor contactor, Liquid Line Solenoid valve (LLSV) and Hot-gas Bypass valve (HGBP) will energize.
- Hot-gas Bypass valve will remain on for three (3) seconds, the Bypass LED will illuminate.

 **NOTE:** The above description is a normal start-up procedure when the actual process temperature is above setpoint temperature.

 **NOTE:** Before pressing the “Start” button, check to ensure the Compressor LED is not flashing. The chiller’s compressor will not start if the LED is flashing.

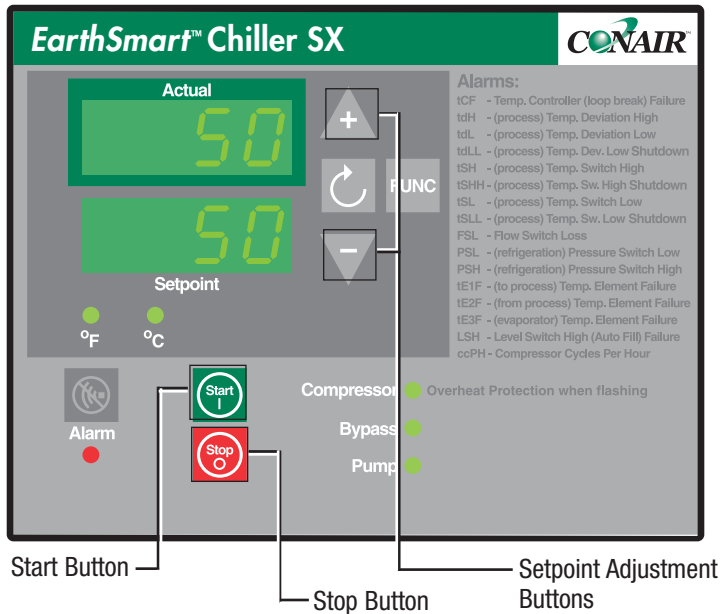
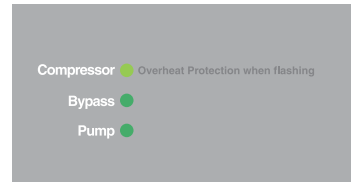

Stopping the Chiller

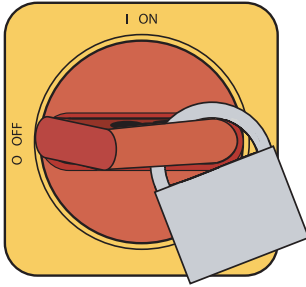

1 Press the STOP button.



- The Liquid Line Solenoid valve (LLSV) will de-energize, causing the compressor to pump down (the compressor pumps refrigerant from the low side of the compressor to the high side until the low pressure switch opens).
- The compressor LED will flash and the compressor will shut down once:
 - The low pressure cut out limit is reached
 - 85 PSI {5.8 bar} for temperature ranges of 40° to 70°F {4.4° to 21.1°C}
 - 50 PSI {3.4 bar} for temperature ranges below 40°F {4.4°C}
 - If the cut out limit is NOT reached, the compressor will shut off after 30 seconds.



2 Be sure to disconnect and/or lockout the main power if you have stopped the chiller to perform maintenance or repair.



IMPORTANT: Do not use the main power switch to stop the chiller. Turning off power to the control and chiller during normal operation prevents the necessary shut down period.

EarthSmart Chiller Sequence of Operation (Normal Running Sequence)

1 The chiller is in running mode. The pump and compressor are on (LEDs are illuminated).



2 The chiller will maintain as close to user-entered setpoint temperature as possible. When the temperature is above setpoint 100% cooling capacity is in effect to cool down the process temperature to setpoint temperature.

3 Process temperature will begin to lower to setpoint temperature. Depending on the PID settings, the Hot-gas Bypass valve (HGBP) will cycle as the process temperature reaches the setpoint temperature. (The Bypass LED will be illuminated)

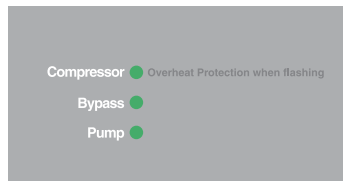

4 If the process temperature begins to ‘drift’ below the setpoint temperature, the HGBP will cycle to increase actual temperature to maintain the setpoint temperature. (Bypass LED will illuminate)

- If actual temperature drops below the setpoint temperature by 4°F {2.2°C} (for more than four (4) seconds) this will cause the compressor to start its shut down sequence. Within thirty (30) seconds the chiller’s compressor will shut off, but the pump will remain on and functioning.
- The compressor will start only after the guaranteed off timer has expired and when the actual temperature is above the setpoint temperature by 2°F {1.1°C}.



NOTE: For air-cooled models, the fan(s) will remain on until the coolant discharge pressure falls below the fan cut-out pressure (320 PSI {22.1 bar})



NOTE: For water-cooled models, the condenser water regulating valve will remain open until the coolant pressure drops below the valve’s setting.

Adjusting Setpoint Temperature

Use the temperature setpoint to set the temperature of the process coolant that will exit the chiller at the “To Process” outlet. Depending on the chiller’s Process Variable Selection, the actual temperature will be measured from the process, to the process or an average of both. *See Operation section entitled, Adjusting the Process Variable Selection.*

To adjust the temperature setpoint:



- 1 Use the (+) or (-) buttons to increase or decrease the temperature setpoint from the Main Menu screen.** Holding down the (+) or (-) buttons will cause the setpoint to ramp up or ramp down at a faster rate. The temperature setpoint will be automatically saved to the chiller’s controller. The chiller will begin to raise or lower the process temperature, according to your setting.

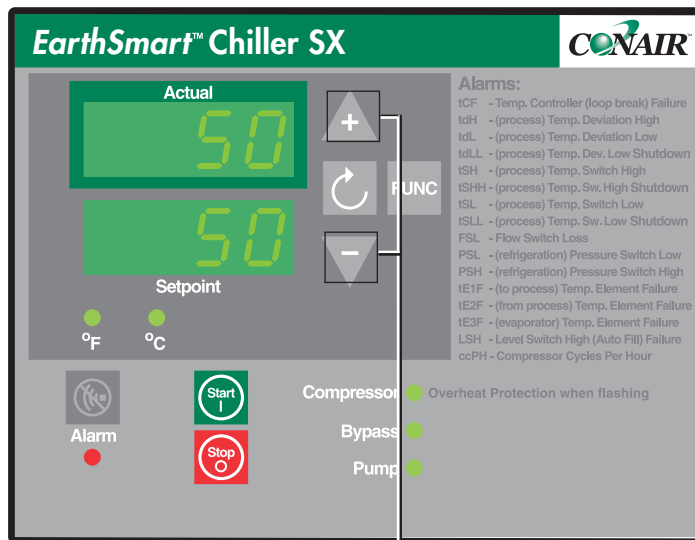

Setpoint Adjustment Buttons

How to Use the Supervisor's Password

The supervisor's password must be entered before you can use or make changes to some screens on the EarthSmart Chiller's control.

To enter the supervisor password:

- 1 Press and release both the “Scroll” and “Function” buttons together until the main screen of the Setup Menu (Screen 83) is displayed.

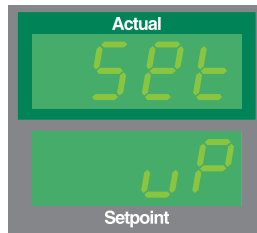

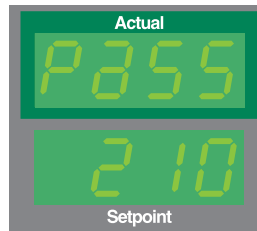

- 2 Press the “Scroll” button until the Password screen (Screen 84) is displayed.



- 3 Use the (+) or (-) buttons to increase or decrease the number in the lower screen. Holding down the (+) or (-) buttons will cause the number to ramp up or down at a faster rate. The default supervisory password is 210. Enter this number to make changes to screens where the supervisor's password is necessary to use or change a function of the chiller.

- 4 Press the “Scroll” button to lock in the selection or press the “Function” button to lock in the selection and exit to the Main Menu.

 **NOTE:** The Supervisor's Password will be active for ten minutes. After ten minutes the password must be entered again to alter supervisor password screens.

 **NOTE:** Entering the password is required to access all shaded screens. See [Operation section entitled, EarthSmart Chiller Menu Tree](#).



 **TIP:** Pressing and holding the “Scroll” button while pressing the “Function” button will increase menu navigation speed.



Autotuning Requirements

Autotuning enhances the EarthSmart Chiller control's ability to govern actual process temperature in relation to setpoint temperature. It is advised to perform an Autotune only under normal operating conditions and specifications.

See below for requirements for a successful Autotune:

- **The chiller must be in “Stop” mode and under normal load.**
- **All components of the chiller must be in proper working order.**
- **The chiller’s process coolant should be 20°F {11.2°C} above or below the user-entered setpoint.** The chiller can Autotune from above the user-entered setpoint. However, since the chiller controls the process temperature by introducing hot gas into the process, it is recommended to start with a process temperature that is 20°F {-6.7°C} below the user-entered setpoint.

See Troubleshooting section entitled, Autotune Errors, for diagnoses of error codes during Autotuning.

Autotuning Procedure

Autotuning enhances the EarthSmart Chiller control's ability to govern actual process temperature in relation to setpoint temperature. Preloaded parameters are used to adjust the chiller's operation to obtain optimum functionality. It is advised to perform an Autotune only under normal operating conditions and specifications.

➡ **TIP:** Pressing and holding the “**Scroll**” button while pressing the “**Function**” button will increase menu navigation speed.

To perform an Autotune:

- 1 Adjust the Process Variable Selection.** Select the Process Variable the control will use for Autotuning to optimize performance. *See Operation section entitled, Adjusting the Process Variable Selection.*
- 2 Adjust the AutoTune PID cycle time setting.** Press and release both the “Scroll” and “Function” buttons together until the main screen of the Process Menu (Screen 9) is displayed.

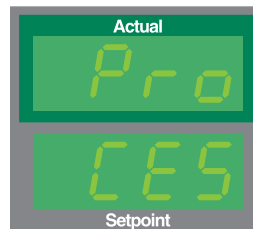

Autotuning Procedure (continued)

- 3** Press the “Scroll” button until the Cycle screen (Screen 16) is displayed.

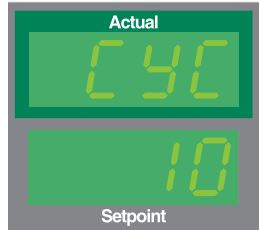

- 4** Use the (+) or (-) buttons to increase or decrease the amount of cycle time. The PID settings will cycle within the time set at this screen. A short time setting will improve how closely the chiller will maintain temperature, but it will reduce the life expectancy of the HGBP valve. A longer time setting will not control the chiller’s temperature closely, but will extend the life expectancy of the HGBP valve. Standard default setting is 10 seconds.

- 5** Press the “Scroll” button to lock in the selection or press the “Function” button to lock in the selection and exit to the Main Menu.

- 6** Lower the user-entered setpoint to a minimum of 20°F {11.2°C} below the actual process temperature by using the (+) or (-) buttons.

- 7** Press the “Start” button to have the chiller begin lowering the process temperature to the user-entered setpoint.

- 8** Press the “Stop” button to place the chiller in “Standby” mode, once the actual temperature is at the user-entered temperature.

- 9** Increase the user-entered temperature setpoint to a minimum of 20°F {11.2°C} above the actual process temperature by using the (+) or (-) buttons.

- 10** Enter the Supervisor’s password within the Setup Menu Branch. *See Operation section entitled, Using Supervisor’s Password.*

- 11** **Activate AutoTune.** Press and release both the “Scroll” and “Function” buttons together until the main screen of the Process Menu (Screen 9) is displayed.

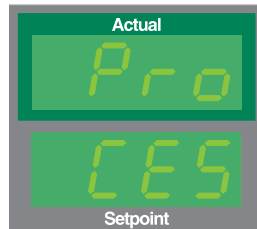

➡ **TIP:** Pressing and holding the “Scroll” button while pressing the “Function” button will increase menu navigation speed.

Autotuning Procedure (continued)



12 Once at the Process Menu Branch, press the “Scroll” button until the Autotune screen (Screen 11) is displayed.

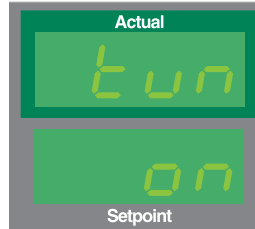

13 Use the (+) or (-) buttons to turn “on” or “off” the Autotune.



14 Press the “Function” button to start the Autotune.

15 Wait for the control to complete the Autotune cycle. During the Autotune several messages may be shown in the LED display:

- “tune SetL” - The system is setting the measured values from the control reference.
- “tune run” - The system is calculating the optimal PID settings.
- “tune done” - The system has completed the Autotune cycle and has saved the PID parameters.



NOTE: In the event that an error is displayed during Autotuning, *see* [Troubleshooting section entitled, Autotune Errors.](#)



NOTE: When performing an Autotune, the duration for the chiller to complete one tune will be at least ten (10) minutes.

16 Press the “Stop” button once to return the chiller to normal operation, after the Autotune cycle is complete.

Changing from Fahrenheit to Celsius Units

The EarthSmart Chiller’s display can be programmed to display either Fahrenheit or Celsius temperature units.

To select either Fahrenheit or Celsius temperature units:

- 1** Enter the Supervisor’s password within the Setup Menu Branch. *See Operation section entitled, Using Supervisor’s Password.*
- 2** Press the “Function” button to save the password entry and exit to the Main Menu.
- 3** Press and release both the “Scroll” and “Function” buttons together until the main screen of the Setup Menu (Screen 83) is displayed.

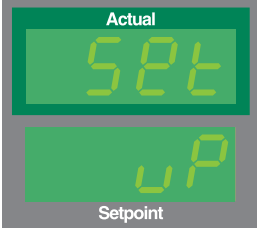

- 4** Press the “Scroll” button until the Units screen (Screen 85) is displayed.



- 5** Use the (+) or (-) buttons to toggle between Fahrenheit or Celsius.
- 6** Press the “Scroll” button to lock in the selection or press the “Function” button to lock in the selection and exit to the Main Menu.

TIP: Pressing and holding the “Scroll” button while pressing the “Function” button will increase menu navigation speed.



Enabling/Disabling Display Decimal Point for Temperature

➤ **TIP:** Pressing and holding the “**Scroll**” button while pressing the “**Function**” button will increase menu navigation speed.

The EarthSmart Chiller’s display can be programmed to display temperature units (Fahrenheit or Celsius) up to one decimal point.

To enable/disable decimal point temperature control readout:

1 Enter the Supervisor’s password within the Setup Menu Branch. *See Operation section entitled, Using Supervisor’s Password.*

FUNC

2 Press the “**Function**” button to save the password entry and exit to the Main Menu.



FUNC

3 Press and release both the “**Scroll**” and “**Function**” buttons together until the main screen of the Setup Menu (Screen 83) is displayed.

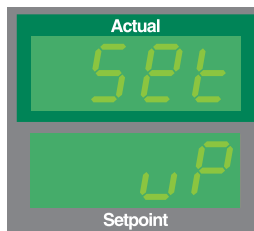

4 Press the “**Scroll**” button until the Display Decimal Point screen (Screen 86) is displayed.

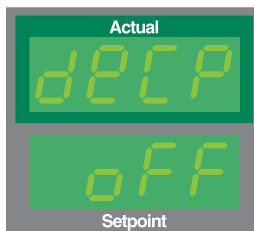

5 Use the (+) or (-) buttons to turn on or off the decimal point readout.



6 Press the “**Scroll**” button to lock in the selection or press the “**Function**” button to lock in the selection and exit to the Main Menu.

Glycol Operation Enable/Disable

The EarthSmart Chiller’s process coolant can be mixed with glycol for lower process temperature operation. Proper water to glycol mixture is required for your specific process temperature. The EarthSmart Chiller does not monitor the percentage of glycol to water. *See Installation section entitled, Filling the Chiller.*

 **WARNING:** Warranty does **NOT** include evaporator freeze-up.

To enable/disable glycol operation:

- 1 Enter the Supervisor’s password within the Setup Menu Branch.** *See Operation section entitled, Using Supervisor’s Password.*
- 2 Press the “Function” button** to save the password entry and exit to the Main Menu.
- 3 Press and release both the “Scroll” and “Function” buttons together until the main screen of the Setup Menu (Screen 83) is displayed.**

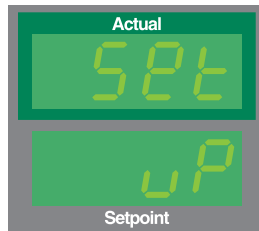

- 4 Press the “Scroll” button until the Glycol screen (Screen 88) is displayed.**

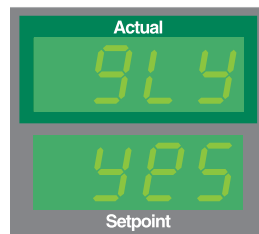

- 5 Use the (+) or (-) buttons to toggle between “Yes” or “No” for glycol mixture.**
- 6 Press the “Scroll” button to lock in the selection** or press the “Function” button to lock in the selection and exit to the Main Menu.

 **TIP:** Pressing and holding the “Scroll” button while pressing the “Function” button will increase menu navigation speed.

 **NOTE:** The Process Low Alarm Setpoint **must** be adjusted lower when enabling Glycol operation, *see Operation section entitled, Adjusting the Process Low Alarm Setpoint (L.AL)*



Adjusting the Process Variable Selection

◆ **TIP:** Pressing and holding the “Scroll” button while pressing the “Function” button will increase menu navigation speed.

The EarthSmart Chiller’s controller allows the user to select where the “Actual” process temperature will be read from. (“To Process”, “From Process” or “Average”) Depending upon the specific setup of your process, adjusting this parameter will provide a more accurate temperature readout.

To adjust the Process Variable Selection:



1 Press and release both the “Scroll” and “Function” buttons together until the main screen of the Input Menu (Screen 26) is displayed.

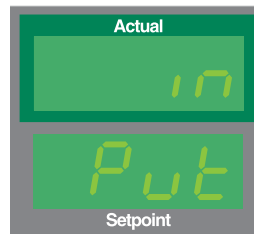

2 Press the “Scroll” button until the Control screen (Screen 27) is displayed.



3 Use the (+) or (-) buttons to toggle between “to”, “fro” or “Avg” selections.



4 Press the “Scroll” button to lock in the selection or press the “Function” button to lock in the selection and exit to the Main Menu.

 **NOTE:** Conair recommends using the “To Process” process variable selection to protect against freezing of the coolant. “From Process” and “Average” process variable selections are less accurate and promote nuisance alarms.

Autofill Enable/Disable (optional)

The optional Autofill feature automatically fills the chiller's internal reservoir. An optional Conair-supplied level switch located inside the reservoir indicates whether the chiller requires more process coolant or when it has been filled to capacity. *See Appendix G entitled, Installing Autofill (optional).*

To enable/disable the Autofill option:

- 1 Enter the Supervisor's password within the Setup Menu Branch.** *See Operation section entitled, Using Supervisor's Password.*
- 2 Press the "Function" button** to save the password entry and exit to the Main Menu.
- 3 Press and release both the "Scroll" and "Function" buttons together until the main screen of the Setup Menu (Screen 83) is displayed.**

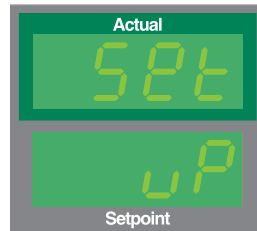

- 4 Press the "Scroll" button until the Autofill screen (Screen 87) is displayed.**

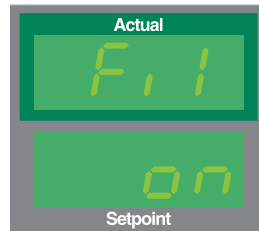

- 5 Use the (+) or (-) buttons to enable or disable the Autofill option.**
- 6 Press the "Scroll" button to lock in the selection** or press the "Function" button to lock in the selection and exit to the Main Menu.

TIP: Pressing and holding the "Scroll" button while pressing the "Function" button will increase menu navigation speed.

IMPORTANT: The optional Autofill function will not operate without the level switch and auxiliary board.



Setting Serial Modbus Communication ID

➡ **TIP:** Pressing and holding the “**Scroll**” button while pressing the “**Function**” button will increase menu navigation speed.

 **NOTE:** Ethernet communications will require configuration through the ethernet control software.

The EarthSmart Chiller can be configured to communicate over a Modbus network. An optional kit must be installed for the chiller to use the Modbus network. This optional kit will include: a communications daughter card, internal connecting harness and a panel mount DB-9 terminal. *See Appendix K entitled, EarthSmart Chiller Modbus Communications, for assigning Modbus address settings.*

To set the EarthSmart Chiller’s Modbus address:

1 Enter the Supervisor’s password within the Setup Menu Branch. *See Operation section entitled, Using Supervisor’s Password.*



2 Press the “**Function**” button to save the password entry and exit to the Main Menu.



3 Press and release both the “**Scroll**” and “**Function**” buttons together until the main screen of the Setup Menu (Screen 83) is displayed.

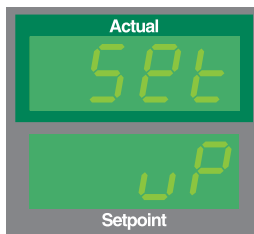

4 Press the “**Scroll**” button until the Communications screen (Screen 89) is displayed.

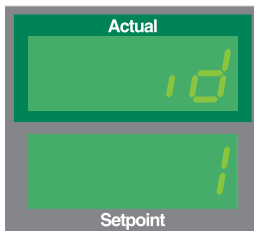

5 Use the (+) or (-) buttons to increase or decrease the address number assignment. *See Appendix K entitled, EarthSmart Chiller Modbus Communications.*



6 Press the “**Scroll**” button to lock in the selection or press the “**Function**” button to lock in the selection and exit to the Main Menu.

7 Restart the chiller for the changes to take effect.

Adjusting Serial Baud Rate

The EarthSmart Chiller’s controller allows the user to select the Baud Rate of their particular communications network. The selections are 2400, 4800, 9600 and 19200.

To adjust the Baud Rate selection:

- 1 Enter the Supervisor’s password within the Setup Menu Branch.** *See Operation section entitled, Using Supervisor’s Password.*
- 2 Press the “Function” button** to save the password entry and exit to the Main Menu.
- 3 Press and release both the “Scroll” and “Function” buttons together** until the main screen of the Setup Menu (Screen 83) is displayed.

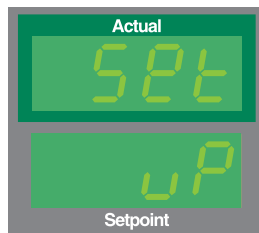

- 4 Press the “Scroll” button** until the Baud Rate screen (Screen 90) is displayed.

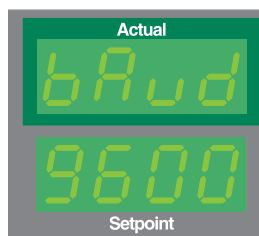

- 5 Use the (+) or (-) buttons** to select the Baud Rate of your communications network. (2400, 4800, 9600 and 19200)
- 6 Press the “Scroll” button** to lock in the selection or press the “Function” button to lock in the selection and exit to the Main Menu.
- 7 Restart the chiller** for the changes to take effect.

TIP: Pressing and holding the “Scroll” button while pressing the “Function” button will increase menu navigation speed.



Setting Alarm Parameters



NOTE: Upon chiller start-up. If an alarm condition exists, both the Inhibit and Delay time settings will be additive. Both times will have to expire before the chiller's control will indicate an alarm condition.



WARNING: Only a qualified electrical technician, trained in the use of this equipment should adjust this setting. Improper adjustment can be harmful to the compressor's life span and may void warranty.

The EarthSmart Chiller alarm parameters can be set according to your particular application. Most alarms include an inhibit time and a delay time before actually indicating an alarm condition. The inhibit time and delay times are used to avoid repeated alarming that may otherwise allow the chiller to resume normal operating conditions.

- **Inhibit Time** - This is the time the chiller's control will ignore an alarm input while initially starting the chiller. (Pushing the "Start" button)
- **Delay Time** - This is the time the chiller's control will ignore an alarm input during normal operating conditions of the chiller.

Adjusting the Low Pressure Inhibit Time (LP.i)

This setting allows the user to set the time from when a low refrigerant pressure alarm is detected to when the alarm signals upon chiller start-up. The range for this setting is 0 to 120 seconds and the standard default setting is 60 seconds.

To adjust the control's Low Pressure Inhibit Time:

1 Enter the Supervisor's password within the Setup Menu Branch. *See Operation section entitled, Using Supervisor's Password.*



2 Press the "Function" button to save the password entry and exit to the Main Menu.



3 Press and release both the "Scroll" and "Function" buttons together until the main screen of the Alarm Setup Menu (Screen 49) is displayed.

• **TIP:** Pressing and holding the "Scroll" button while pressing the "Function" button will increase menu navigation speed.

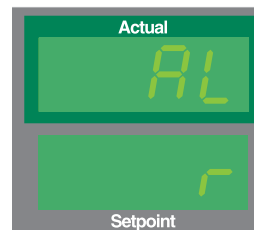

(continued)

Adjusting the Low Pressure Inhibit Time (LP.i) (continued)

- 4** Press the “Scroll” button until the Low Pressure Inhibit screen (Screen 50) is displayed.

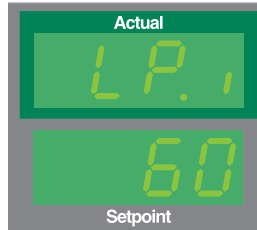

- 5** Use the (+) or (-) buttons to increase or decrease the amount of time delay.
- 6** Press the “Scroll” button to lock in the selection or press the “Function” button to lock in the selection and exit to the Main Menu.





WARNING: Only a qualified electrical technician, trained in the use of this equipment should adjust this setting. Improper adjustment can be harmful to the compressor's life span and may void warranty.

Adjusting the Low Pressure Delay Time (LP.d)

This setting allows the user to set the time from when a low refrigerant pressure alarm is detected when the chiller is in normal operation. The range for this setting is 0 to 30 seconds and the standard default setting is 5 seconds.

To adjust the control's Low Pressure Delay Time:

- 1** Enter the Supervisor's password within the Setup Menu Branch. *See Operation section entitled, Using Supervisor's Password.*
- 2** Press the "Function" button to save the password entry and exit to the Main Menu.
- 3** Press and release both the "Scroll" and "Function" buttons together until the main screen of the Alarm Setup Menu (Screen 49) is displayed.



FUNC



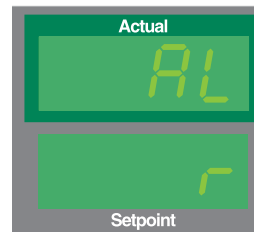

FUNC

TIP: Pressing and holding the "Scroll" button while pressing the "Function" button will increase menu navigation speed.

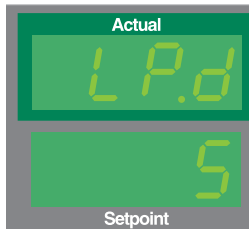

- 4** Press the "Scroll" button until the Low Pressure Inhibit screen (Screen 51) is displayed.



- 5** Use the (+) or (-) buttons to increase or decrease the amount of time delay.



- 6** Press the "Scroll" button to lock in the selection or press the "Function" button to lock in the selection and exit to the Main Menu.

Adjusting the Flow Switch Alarm Inhibit Time (FL.i)

This setting ensures that there is adequate flow through the evaporator before allowing the compressor to start. The time set at this screen is the time after initial start-up of the chiller that the control will wait before indicating an alarm and shutting down, if there is no flow. The range for this setting is 0 to 60 seconds and the standard default setting is 10 seconds.

TIP: Pressing and holding the “Scroll” button while pressing the “Function” button will increase menu navigation speed.

To adjust the control’s Flow Switch Alarm Inhibit Time:

- 1** Enter the Supervisor’s password within the Setup Menu Branch. *See Operation section entitled, Using Supervisor’s Password.*
- 2** Press the “Function” button to save the password entry and exit to the Main Menu.
- 3** Press and release both the “Scroll” and “Function” buttons together until the main screen of the Alarm Setup Menu (Screen 49) is displayed.

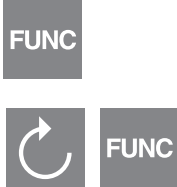

Operation 4

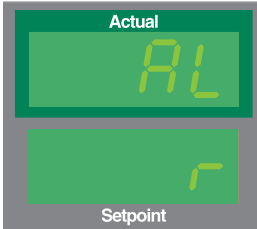

- 4** Press the “Scroll” button until the Flow Switch Inhibit screen (Screen 52) is displayed.

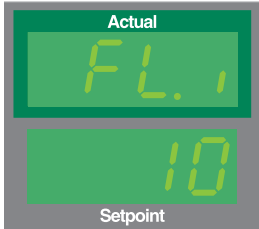

- 5** Use the (+) or (-) buttons to increase or decrease the amount of time delay.
- 6** Press the “Scroll” button to lock in the selection or press the “Function” button to lock in the selection and exit to the Main Menu.



Adjusting the Flow Switch Alarm Delay Time (FL.d)

◆ **TIP:** Pressing and holding the “Scroll” button while pressing the “Function” button will increase menu navigation speed.

This setting ensures that there is adequate flow through the evaporator during normal chiller operation. The time set at this screen is the time the control will wait before indicating an alarm and shutting down, if there is no flow. The range for this setting is 0 to 30 seconds and the standard default setting is 5 seconds.

To adjust the control’s Flow Switch Alarm Delay Time:

1 Enter the Supervisor’s password within the Setup Menu Branch. *See Operation section entitled, Using Supervisor’s Password.*



2 Press the “Function” button to save the password entry and exit to the Main Menu.



3 Press and release both the “Scroll” and “Function” buttons together until the main screen of the Alarm Setup Menu (Screen 49) is displayed.

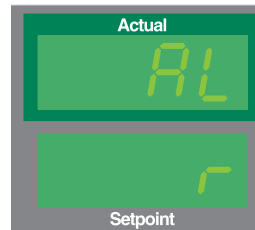

4 Press the “Scroll” button until the Flow Switch Delay screen (Screen 53) is displayed.

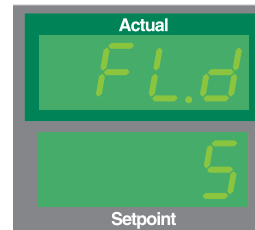

5 Use the (+) or (-) buttons to increase or decrease the amount of time delay.



6 Press the “Scroll” button to lock in the selection or press the “Function” button to lock in the selection and exit to the Main Menu.

Adjusting the Process High Alarm Setpoint (H.AL)

This setting ensures the chiller does not exceed maximum operational temperature and alerts the user with a passive alarm to abnormal operating temperatures. The range for this setting is 0° to 85°F {-17° to 29.4°C} and the standard default setting is 85°F {29.4°C}.

To adjust the control's Process High Alarm Setpoint:

- 1 Enter the Supervisor's password within the Setup Menu Branch.** *See Operation section entitled, Using Supervisor's Password.*
- 2 Press the "Function" button** to save the password entry and exit to the Main Menu.
- 3 Press and release both the "Scroll" and "Function" buttons together** until the main screen of the Alarm Setup Menu (Screen 49) is displayed.

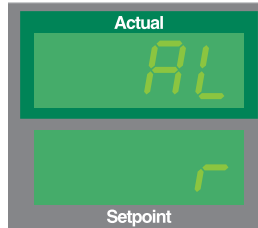

- 4 Press the "Scroll" button** until the Process High Alarm Setpoint screen (Screen 54) is displayed.

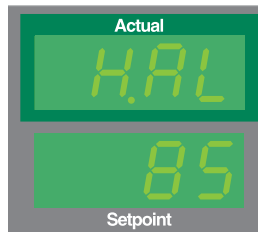

- 5 Use the (+) or (-) buttons** to increase or decrease the temperature setting.
- 6 Press the "Scroll" button** to lock in the selection or press the "Function" button to lock in the selection and exit to the Main Menu.

TIP: Pressing and holding the "Scroll" button while pressing the "Function" button will increase menu navigation speed.



Adjusting the Process High Alarm Inhibit Time (HA.i)

◆ **TIP:** Pressing and holding the “**Scroll**” button while pressing the “**Function**” button will increase menu navigation speed.

This setting ensures the chiller will have enough time to lower the process coolant’s temperature during initial chiller start-up before alerting the user with a passive alarm. The range for this setting is 0 to 300 seconds and the standard default setting is 10 seconds.

To adjust the control’s Process High Alarm Inhibit Time:

1 Enter the Supervisor’s password within the Setup Menu Branch. *See Operation section entitled, Using Supervisor’s Password.*



2 Press the “**Function**” button to save the password entry and exit to the Main Menu.



3 Press and release both the “**Scroll**” and “**Function**” buttons together until the main screen of the Alarm Setup Menu (Screen 49) is displayed.

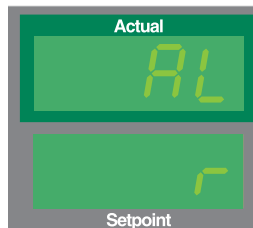

4 Press the “**Scroll**” button until the Process High Alarm Inhibit screen (Screen 55) is displayed.

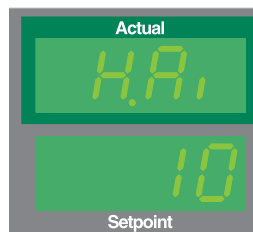

5 Use the (+) or (-) buttons to increase or decrease the amount of time delay.



6 Press the “**Scroll**” button to lock in the selection or press the “**Function**” button to lock in the selection and exit to the Main Menu.

Adjusting the Process High Alarm Delay Time (HA.d)

This setting ensures the chiller will have enough time to lower the process coolant's temperature during normal operation before alerting the user with a passive alarm. The range for this setting is 0 to 60 seconds and the standard default setting is 5 seconds.

To adjust the control's Process High Alarm Delay Time:

- 1** Enter the Supervisor's password within the Setup Menu Branch. *See Operation section entitled, Using Supervisor's Password.*
- 2** Press the "Function" button to save the password entry and exit to the Main Menu.
- 3** Press and release both the "Scroll" and "Function" buttons together until the main screen of the Alarm Setup Menu (Screen 49) is displayed.

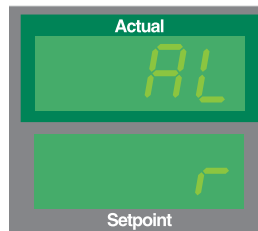

- 4** Press the "Scroll" button until the Process High Alarm Delay screen (Screen 56) is displayed.

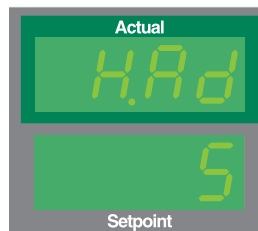

- 5** Use the (+) or (-) buttons to increase or decrease the amount of time delay.
- 6** Press the "Scroll" button to lock in the selection or press the "Function" button to lock in the selection and exit to the Main Menu.

TIP: Pressing and holding the "Scroll" button while pressing the "Function" button will increase menu navigation speed.



Adjusting the Process High Temperature Shutdown Setpoint (H.SA)

• TIP: Pressing and holding the “Scroll” button while pressing the “Function” button will increase menu navigation speed.

This setting is the absolute highest temperature the chiller can reach before immediately alarming and shutting down due to abnormal operating temperatures. The range for this setting is 50° to 100°F {10° to 37.8°C} and the standard default setting is 95°F {35°C}.

To adjust the control’s Process High Temperature Shutdown Setpoint:

1 Enter the Supervisor’s password within the Setup Menu Branch. *See Operation section entitled, Using Supervisor’s Password.*



2 Press the “Function” button to save the password entry and exit to the Main Menu.



3 Press and release both the “Scroll” and “Function” buttons together until the main screen of the Alarm Setup Menu (Screen 49) is displayed.

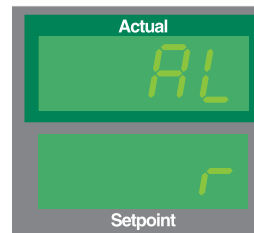

4 Press the “Scroll” button until the Process High Alarm Shutdown Setpoint screen (Screen 57) is displayed.

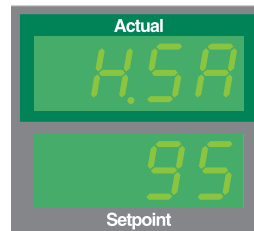

5 Use the (+) or (-) buttons to increase or decrease the temperature setting.



6 Press the “Scroll” button to lock in the selection or press the “Function” button to lock in the selection and exit to the Main Menu.

Adjusting the Process High Temperature Shutdown Inhibit Time (H.Si)

This setting ensures the chiller will begin to lower the process coolant’s temperature during initial chiller start-up before alerting the user to a shut down alarm. The range for this setting is 0 to 900 seconds and the standard default setting is 300 seconds.

To adjust the control’s Process High Temperature Shutdown Inhibit Time:

- 1 Enter the Supervisor’s password within the Setup Menu Branch.** *See Operation section entitled, Using Supervisor’s Password.*
- 2 Press the “Function” button** to save the password entry and exit to the Main Menu.
- 3 Press and release both the “Scroll” and “Function” buttons together until the main screen of the Alarm Setup Menu (Screen 49) is displayed.**

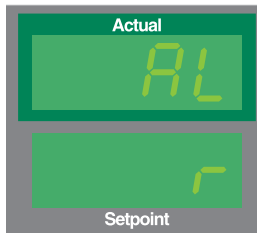

- 4 Press the “Scroll” button until the Process High Shutdown Inhibit screen (Screen 58) is displayed.**

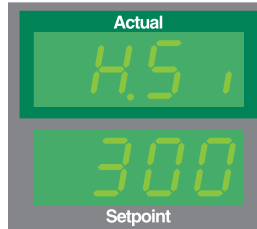

- 5 Use the (+) or (-) buttons to increase or decrease the amount of time delay.**
- 6 Press the “Scroll” button to lock in the selection or press the “Function” button to lock in the selection and exit to the Main Menu.**

TIP: Pressing and holding the “Scroll” button while pressing the “Function” button will increase menu navigation speed.



Adjusting the Process High Temperature Shutdown Delay Time (H.Sd)

• TIP: Pressing and holding the “Scroll” button while pressing the “Function” button will increase menu navigation speed.

This setting ensures the chiller will begin to lower the process coolant’s temperature during normal operation before alerting the user to a shut down alarm. The range for this setting is 0 to 60 seconds and the standard default setting is 5 seconds.

To adjust the control’s Process High Temperature Shutdown Delay Time:

1 Enter the Supervisor’s password within the Setup Menu Branch. *See Operation section entitled, Using Supervisor’s Password.*



2 Press the “Function” button to save the password entry and exit to the Main Menu.



3 Press and release both the “Scroll” and “Function” buttons together until the main screen of the Alarm Setup Menu (Screen 49) is displayed.

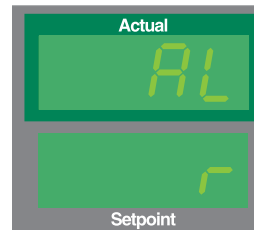

4 Press the “Scroll” button until the Process High Shutdown Delay screen (Screen 59) is displayed.

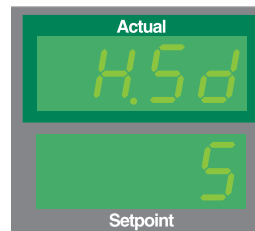

5 Use the (+) or (-) buttons to increase or decrease the amount of time delay.



6 Press the “Scroll” button to lock in the selection or press the “Function” button to lock in the selection and exit to the Main Menu.

Adjusting the Process Low Alarm Setpoint (L.AL)

This setting ensures the chiller does not drop below the minimum operational temperature and alerts the user with a passive alarm to abnormal operating temperatures. The range for this setting is 35° to 50°F {-1.7° to 10°C} or if a glycol mixture is being used, 15° to 50°F {-9.4° to 10°C} and the standard default setting is 40°F {4.4°C}.

To adjust the control's Process Low Alarm Setpoint:

- 1** Enter the Supervisor's password within the Setup Menu Branch. *See Operation section entitled, Using Supervisor's Password.*
- 2** Press the "Function" button to save the password entry and exit to the Main Menu.
- 3** Press and release both the "Scroll" and "Function" buttons together until the main screen of the Alarm Setup Menu (Screen 49) is displayed.

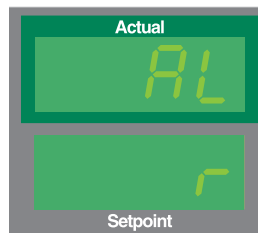

- 4** Press the "Scroll" button until the Process Low Alarm Setpoint screen (Screen 60) is displayed.

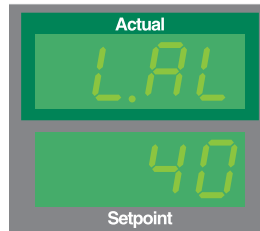

- 5** Use the (+) or (-) buttons to increase or decrease the temperature setting.
- 6** Press the "Scroll" button to lock in the selection or press the "Function" button to lock in the selection and exit to the Main Menu.

TIP: Pressing and holding the "Scroll" button while pressing the "Function" button will increase menu navigation speed.



Adjusting the Process Low Alarm Inhibit Time (L.Ai)

❖ **TIP:** Pressing and holding the “Scroll” button while pressing the “Function” button will increase menu navigation speed.

This setting ensures the chiller will begin to raise the process coolant’s temperature during initial chiller start-up before alerting the user with a passive alarm. The range for this setting is 0 to 180 seconds and the standard default setting is 10 seconds.

To adjust the control’s Process Low Inhibit Time:

1 Enter the Supervisor’s password within the Setup Menu Branch. *See Operation section entitled, Using Supervisor’s Password.*



2 Press the “Function” button to save the password entry and exit to the Main Menu.



3 Press and release both the “Scroll” and “Function” buttons together until the main screen of the Alarm Setup Menu (Screen 49) is displayed.

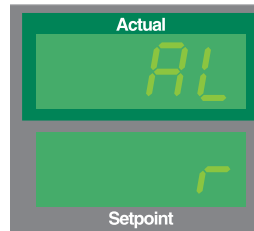

4 Press the “Scroll” button until the Process Low Alarm Inhibit screen (Screen 61) is displayed.

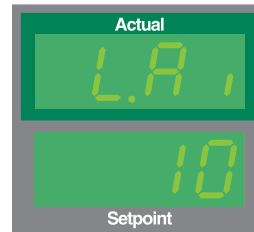

5 Use the (+) or (-) buttons to increase or decrease the amount of time delay.



6 Press the “Scroll” button to lock in the selection or press the “Function” button to lock in the selection and exit to the Main Menu.

Adjusting the Process Low Alarm Delay Time (L.Ad)

This setting ensures the chiller will begin to raise the process coolant’s temperature during normal operation before alerting the user with a passive alarm. The range for this setting is 0 to 180 seconds and the standard default setting is 10 seconds.

To adjust the control’s Process Low Delay Time:

- 1** Enter the Supervisor’s password within the Setup Menu Branch. *See Operation section entitled, Using Supervisor’s Password.*
- 2** Press the “Function” button to save the password entry and exit to the Main Menu.
- 3** Press and release both the “Scroll” and “Function” buttons together until the main screen of the Alarm Setup Menu (Screen 49) is displayed.

• **TIP:** Pressing and holding the “Scroll” button while pressing the “Function” button will increase menu navigation speed.

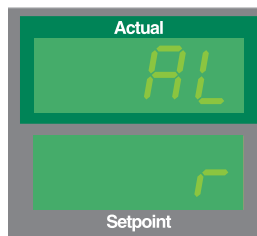

- 4** Press the “Scroll” button until the Process Low Alarm Delay screen (Screen 62) is displayed.

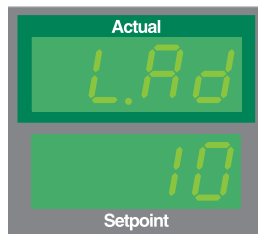

- 5** Use the (+) or (-) buttons to increase or decrease the amount of time delay.
- 6** Press the “Scroll” button to lock in the selection or press the “Function” button to lock in the selection and exit to the Main Menu.



Adjusting the Process Deviation High Alarm Setpoint (dE.H)

• **TIP:** Pressing and holding the “Scroll” button while pressing the “Function” button will increase menu navigation speed.

This setting is used to activate a Process Deviation High Passive Alarm when the chiller’s actual process temperature exceeds the user-entered temperature by the value set at this screen. The range for this setting is 0° to 25° {0 to 14° C} and the standard default setting is 5°F {2.8°C}.

To adjust the control’s Process Deviation High Alarm Setpoint:

1 Enter the Supervisor’s password within the Setup Menu Branch. *See Operation section entitled, Using Supervisor’s Password.*



2 Press the “Function” button to save the password entry and exit to the Main Menu.



3 Press and release both the “Scroll” and “Function” buttons together until the main screen of the Alarm Setup Menu (Screen 49) is displayed.

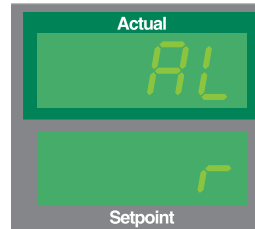

4 Press the “Scroll” button until the Process Deviation High Alarm screen (Screen 63) is displayed.

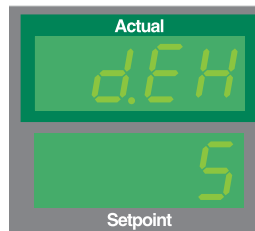

5 Use the (+) or (-) buttons to increase or decrease the temperature setting.



6 Press the “Scroll” button to lock in the selection or press the “Function” button to lock in the selection and exit to the Main Menu.

Adjusting the Process Deviation Low Alarm Setpoint (dE.L)

This setting is used to activate a Process Deviation High Passive Alarm when the chiller’s actual process temperature drops below the user-entered temperature by the value set at this screen. The range for this setting is 0° to 25° {0 to 14° C} and the standard default setting is 5°F {2.8°C}.

To adjust the control’s Process Deviation Low Alarm Setpoint:

- 1 Enter the Supervisor’s password within the Setup Menu Branch.** *See Operation section entitled, Using Supervisor’s Password.*
- 2 Press the “Function” button** to save the password entry and exit to the Main Menu.
- 3 Press and release both the “Scroll” and “Function” buttons together** until the main screen of the Alarm Setup Menu (Screen 49) is displayed.

TIP: Pressing and holding the “Scroll” button while pressing the “Function” button will increase menu navigation speed.

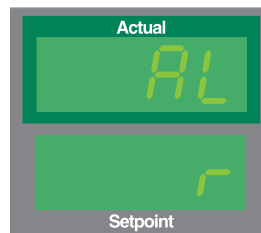

- 4 Press the “Scroll” button** until the Process Deviation Low Alarm screen (Screen 64) is displayed.

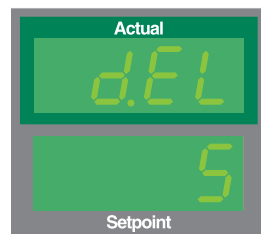

- 5 Use the (+) or (-) buttons** to increase or decrease the temperature setting.
- 6 Press the “Scroll” button** to lock in the selection or press the “Function” button to lock in the selection and exit to the Main Menu.



Adjusting the Process Deviation High Alarm Inhibit Time (dE.i)

➡ **TIP:** Pressing and holding the “Scroll” button while pressing the “Function” button will increase menu navigation speed.

This setting ensures the chiller will begin to lower the process coolant’s temperature during initial chiller start-up before alerting the user with a passive alarm. The range for this setting is 0 to 900 seconds and the standard default setting is 600 seconds.

To adjust the control’s Process Deviation High Alarm Inhibit Time:

1 Enter the Supervisor’s password within the Setup Menu Branch. *See Operation section entitled, Using Supervisor’s Password.*



2 Press the “Function” button to save the password entry and exit to the Main Menu.



3 Press and release both the “Scroll” and “Function” buttons together until the main screen of the Alarm Setup Menu (Screen 49) is displayed.

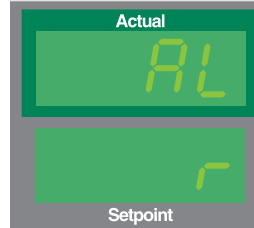

4 Press the “Scroll” button until the Process Deviation High Alarm Inhibit screen (Screen 65) is displayed.

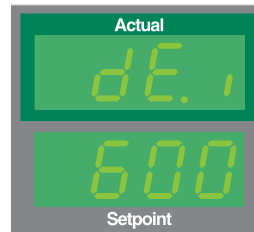

5 Use the (+) or (-) buttons to increase or decrease the amount of time delay.



6 Press the “Scroll” button to lock in the selection or press the “Function” button to lock in the selection and exit to the Main Menu.

Adjusting the Process Deviation High Alarm Delay Time (dE.d)

This setting ensures the chiller will begin to lower the process coolant’s temperature during normal operation before alerting the user with a passive alarm. The range for this setting is 0 to 900 seconds and the standard default setting is 30 seconds.

To adjust the control’s Process Deviation High Alarm Delay Time:

- 1 Enter the Supervisor’s password within the Setup Menu Branch.** *See Operation section entitled, Using Supervisor’s Password.*
- 2 Press the “Function” button** to save the password entry and exit to the Main Menu.
- 3 Press and release both the “Scroll” and “Function” buttons together** until the main screen of the Alarm Setup Menu (Screen 49) is displayed.

TIP: Pressing and holding the “Scroll” button while pressing the “Function” button will increase menu navigation speed.

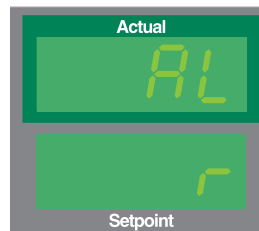

- 4 Press the “Scroll” button** until the Process Deviation High Alarm Delay screen (Screen 66) is displayed.

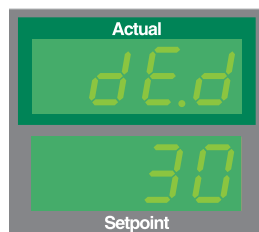

- 5 Use the (+) or (-) buttons** to increase or decrease the amount of time delay.
- 6 Press the “Scroll” button** to lock in the selection or press the “Function” button to lock in the selection and exit to the Main Menu.



Adjusting the Process Deviation Low Shutdown Alarm Setpoint (dL.L)

• TIP: Pressing and holding the “Scroll” button while pressing the “Function” button will increase menu navigation speed.

This setting is used to activate a Process Deviation Low Alarm and shuts down the chiller when the actual process temperature drops below the setting at this screen. The range for this setting is 0° to 80° {0 to 44.9°C} below the user-entered setpoint and the standard default setting is deliberately set at 80°F {44.9°C}.

To adjust the control’s Process Deviation Low Shutdown Alarm Setpoint:

1 Enter the Supervisor’s password within the Setup Menu Branch. *See Operation section entitled, Using Supervisor’s Password.*



2 Press the “Function” button to save the password entry and exit to the Main Menu.



3 Press and release both the “Scroll” and “Function” buttons together until the main screen of the Alarm Setup Menu (Screen 49) is displayed.

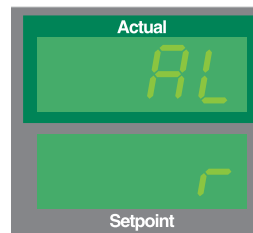

4 Press the “Scroll” button until the Process Deviation Low Shutdown Alarm Setpoint screen (Screen 67) is displayed.

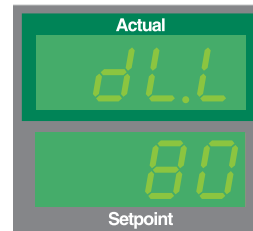

5 Use the (+) or (-) buttons to increase or decrease the temperature setting.



6 Press the “Scroll” button to lock in the selection or press the “Function” button to lock in the selection and exit to the Main Menu.

Enabling/Disabling Process Loop Break (Lb.E)

This setting, when enabled, is used to activate a Process Loop Break Shut Down Alarm when the actual process temperature is slightly higher or lower than the actual user-entered temperature, however, the actual temperature never exceeds the Process Deviation High or Low setpoints.

To enable the Process Loop Break:

- 1 Enter the Supervisor's password within the Setup Menu Branch.** *See Operation section entitled, Using Supervisor's Password.*
- 2 Press the "Function" button** to save the password entry and exit to the Main Menu.
- 3 Press and release both the "Scroll" and "Function" buttons together** until the main screen of the Alarm Setup Menu (Screen 49) is displayed.

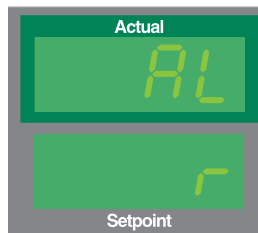

- 4 Press the "Scroll" button** until the Process Loop Break On/Off screen (Screen 68) is displayed.

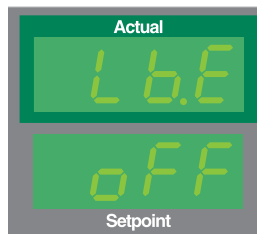

- 5 Use the (+) or (-) buttons** to turn the Process Loop Break on or off.
- 6 Press the "Scroll" button** to lock in the selection or press the "Function" button to lock in the selection and exit to the Main Menu.

TIP: Pressing and holding the "Scroll" button while pressing the "Function" button will increase menu navigation speed.



Adjusting the Process Loop Break Timer (Lb.t)

• **TIP:** Pressing and holding the “Scroll” button while pressing the “Function” button will increase menu navigation speed.

This setting is used to adjust the amount of time after the chiller’s control has detected Process Loop Break until it activates a Process Loop Break Shutdown Alarm. The timer will automatically reset when the chiller’s actual process temperature reaches the user-entered process temperature. The range for this setting is 0 to 900 seconds and the standard default setting is 10 seconds.

To adjust the Process Loop Break Timer:

1 Enter the Supervisor’s password within the Setup Menu Branch. *See Operation section entitled, Using Supervisor’s Password.*



2 Press the “Function” button to save the password entry and exit to the Main Menu.

3 Press and release both the “Scroll” and “Function” buttons together until the main screen of the Alarm Setup Menu (Screen 49) is displayed.

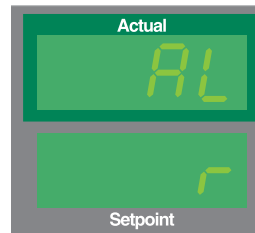

4 Press the “Scroll” button until the Process Loop Break Timer screen (Screen 69) is displayed.



5 Use the (+) or (-) buttons to increase or decrease the amount of time delay.



6 Press the “Scroll” button to lock in the selection or press the “Function” button to lock in the selection and exit to the Main Menu.

Adjusting the Alarm Silence Timer (ALS)

This setting is used to adjust the amount of time after the “Alarm Acknowledgment” button has been pressed that the optional beacon and visual alarm indicators will be deactivated. If, after the “Alarm Acknowledgment” button has been pressed and the alarm condition has not been satisfied, it will re-activate. The range for this setting is 0 to 120 minutes and the standard default setting is 10 minutes.

To adjust the Alarm Silence Timer:

- 1 Enter the Supervisor’s password within the Setup Menu Branch.** *See Operation section entitled, Using Supervisor’s Password.*
- 2 Press the “Function” button** to save the password entry and exit to the Main Menu.
- 3 Press and release both the “Scroll” and “Function” buttons together** until the main screen of the Alarm Setup Menu (Screen 49) is displayed.

➡ **TIP:** Pressing and holding the “Scroll” button while pressing the “Function” button will increase menu navigation speed.

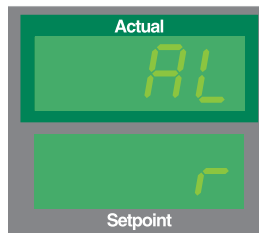

- 4 Press the “Scroll” button** until the Alarm Silence Timer screen (Screen 70) is displayed.

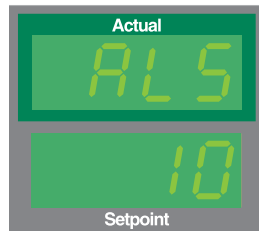

- 5 Use the (+) or (-) buttons** to increase or decrease the temperature setting.
- 6 Press the “Scroll” button** to lock in the selection or press the “Function” button to lock in the selection and exit to the Main Menu.



Adjusting the Autofill Alarm Timer (AF.t) (optional)

◆ TIP: Pressing and holding the “Scroll” button while pressing the “Function” button will increase menu navigation speed.

This setting is used to adjust the amount of time after the chiller’s control has not received an input signal from the optional reservoir float switch before activating an alarm. The range for this setting is 0 to 900 seconds and the standard default setting is 300 seconds.

To adjust the Autofill Alarm Timer:

1 Enter the Supervisor’s password within the Setup Menu Branch. *See Operation section entitled, Using Supervisor’s Password.*



2 Press the “Function” button to save the password entry and exit to the Main Menu.



3 Press and release both the “Scroll” and “Function” buttons together until the main screen of the Alarm Setup Menu (Screen 49) is displayed.

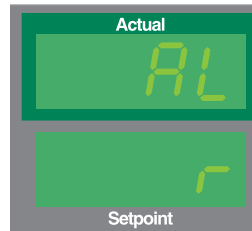

4 Press the “Scroll” button until the Autofill Alarm Timer screen (Screen 71) is displayed.

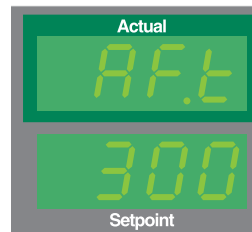

5 Use the (+) or (-) buttons to increase or decrease the amount of time delay.



6 Press the “Scroll” button to lock in the selection or press the “Function” button to lock in the selection and exit to the Main Menu.

Adjusting the Compressor Cycles per Hour Alarm Setpoint (nCCH)

This setting is used to adjust the number of compressor On/Off cycles per hour the chiller’s control will allow before activating a shutdown alarm. The one hour time frame is started when the user presses the “Start” button and refreshes every hour after startup. The range for this setting is 2 to 15 cycles/hour and the standard default setting is 10 cycles per hour.

TIP: Pressing and holding the “Scroll” button while pressing the “Function” button will increase menu navigation speed.

To adjust the Compressor Cycles per Hour Alarm Setpoint:

- 1** Enter the Supervisor’s password within the Setup Menu Branch. *See Operation section entitled, Using Supervisor’s Password.*
- 2** Press the “Function” button to save the password entry and exit to the Main Menu.
- 3** Press and release both the “Scroll” and “Function” buttons together until the main screen of the Alarm Setup Menu (Screen 49) is displayed.

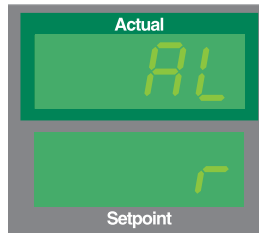

- 4** Press the “Scroll” button until the Compressor Cycles per Hour Alarm Setpoint screen (Screen 72) is displayed.

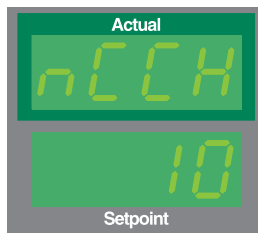

- 5** Use the (+) or (-) buttons to increase or decrease the amount of cycles per hour.
- 6** Press the “Scroll” button to lock in the selection or press the “Function” button to lock in the selection and exit to the Main Menu.



Adjusting the Freeze Protection Shutdown Alarm Setpoint (FP)

➡ **TIP:** Pressing and holding the “Scroll” button while pressing the “Function” button will increase menu navigation speed.

This setting is used to adjust the minimum low temperature setpoint before the chiller will immediately shut down to avoid freezing of the process fluid. The range for this setting is 35° to 50°F {1.7° to 10°C} or if a glycol mixture is used, 15° to 50°F {-9.4° to 10°C}. The standard default setting is 41°F {5°C}.

To adjust the Freeze Protection Shutdown Alarm Setpoint:

1 Enter the Supervisor’s password within the Setup Menu Branch. *See Operation section entitled, Using Supervisor’s Password.*



2 Press the “Function” button to save the password entry and exit to the Main Menu.



3 Press and release both the “Scroll” and “Function” buttons together until the main screen of the Alarm Setup Menu (Screen 49) is displayed.

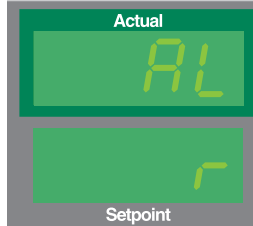

4 Press the “Scroll” button until the Freeze Protection Shutdown Alarm Setpoint screen (Screen 73) is displayed.

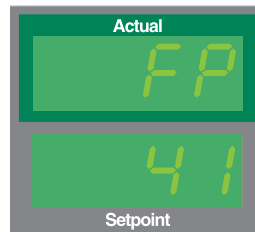

5 Use the (+) or (-) buttons to turn the Process Loop Break on or off.



6 Press the “Scroll” button to lock in the selection or press the “Function” button to lock in the selection and exit to the Main Menu.



Maintenance

Maintenance features	5-2
Warnings and cautions	5-3
Preventative maintenance schedule	5-4
Checking electrical connections	5-6
Cleaning the brazed plate evaporator or water-cooled condenser	5-7
Cleaning the air-cooled condenser	5-10
Checking the refrigerant charge and quality	5-11
Checking the compressor's oil level	5-12
Checking the hot-gas bypass valve operation	5-14
Cleaning the evaporator and condenser "Y" strainer	5-16
Checking or cleaning the flow switch	5-20
Checking reservoir level	5-22
Checking pump performance	5-23
Reloading factory default parameters	5-24

Maintenance Features

Conair EarthSmart Series Chillers need regular, scheduled maintenance for peak performance.

To maintain the best performance of the chiller, it must be cleaned and inspected regularly. Maintenance includes a daily, monthly, and semi-annual schedule. *See Maintenance section entitled, Preventative Maintenance Schedule and Appendix B entitled, Maintenance Log.*

Use this maintenance schedule as a guide. You may need to shorten the time of the maintenance schedule, depending on how often you use the chiller. Among the features that require preventative maintenance are:

- The refrigerant system.
- Electrical cables, terminals and control lights.
- The condenser, condenser filter strainer inlets.
- Caster locks.
- Temperature and pressure readings.
- Process fluid level.
- Energy-efficiency.
- Evaporator, filter strainer at evaporator and condenser inlets.
- Cooling water treatment system (if used).

Warnings and Cautions



WARNING: Improper installation, operation or servicing may result in equipment damage or personal injury.

This equipment should only be installed, adjusted and serviced by a qualified technician who is familiar with the construction, operation and potential hazards of this type of machine.

All wiring, disconnects and fuses should be installed by a qualified electrical technician in accordance with electrical codes in your region.



WARNING: Electrical Hazard

Before performing any work on this item, disconnect and lock out electrical power sources to prevent injury from unexpected energization or startup. Be sure that power to the chiller is OFF when doing any maintenance on the chiller. Follow all safety rules when performing any maintenance on this equipment.



CAUTION: Hot Surfaces

Always protect yourself from hot surfaces when working on the EarthSmart Chiller, especially when working on or around the compressor and condenser. These devices can reach up to 160°F {71°C}. Allow these devices to cool before performing any maintenance or troubleshooting.



WARNING: Refrigerant Hazard

Only a certified refrigerant technicians should examine and correct problems involving the refrigerant circuit.

To maintain the best performance, follow the maintenance schedule and record information in the Maintenance Log in Appendix B.

Preventative Maintenance Schedule

Daily, or as often as needed

- Checking process fluid level in the pump tank**
Check the process fluid level in the water level gauge on the back of the chiller. If low, *see Installation section entitled, Filling the Chiller.*
- Verifying pump discharge pressure**
While the pump is running, check that the pump pressure gauges (not included) are within range. To change the pressure open or close the “To Process” valve.
- Inspecting piping for leaks**
Check to see that pipes are not leaking. Look for standing water on the floor or inside the chiller cabinet, tighten and/or clean as necessary.
- Inspecting the condenser coil for debris (Air-cooled only)**
Remove the wire mesh side panel and filter in front of the condenser coil. Remove any debris from the coils and clean the fan blades. *See Maintenance section entitled, Cleaning the Air-cooled Condenser.*

IMPORTANT: Conair recommends that the wire terminations be tightened during any servicing of the chiller.

Weekly, or as often as needed

- Checking temperature and pressure readings**
Check that the temperature displays on the control screen, on the condenser inlet and outlet and pressure gauges (not included) on the condenser piping indicate normal operation.
- Checking efficiency**
Review the performance data on the Maintenance Log found in Appendix B. If you notice a decrease in efficiency over time, check all heat transfer surfaces of the evaporator and condenser for fouling. Clean as needed.
- Checking refrigerant sight glass**
There should not be any bubbles in the sight glass unless when the Hot-gas Bypass valve (HGBP) is energized. *See Maintenance section entitled, Checking Refrigerant Charge.*
- Checking reservoir level**
Check the water level gauge on the back of the chiller. If fluid level is low, fill. *See Maintenance section entitled, Checking Reservoir Level.*
- Cleaning the Evaporator and Condenser “Y” strainer**
See Maintenance section entitled, Cleaning the Evaporator and Condenser “Y” Strainer.

Preventative Maintenance Schedule

Monthly

- Inspecting cooling water treatment system**
If your chiller uses a cooling water treatment system, maintain proper chemical levels and follow the recommendations of your water treatment specialist. Otherwise, change water in the reservoir tank monthly to decrease water hardness. *See Appendix D entitled, Water Quality Control.*
- Checking electrical connections, amps and volts**
Make sure electrical connections are properly seated. *See Maintenance section entitled, Checking Electrical Connections.* Check fan, compressor, pump, amps and volts by checking the data tag located inside the electrical enclosure. *See Description section entitled, Specifications: EarthSmart ECW and ECA Series.*
- Cleaning**
Wipe all external surfaces to maintain finish.
- Inspecting condenser**
Check the condenser for adequate airflow or water flow. Check the condenser surface for dirt and clogging. If dirt or clogs are present, clean the condenser. *See Maintenance sections entitled, Cleaning the Evaporator or Water-cooled Condenser and Cleaning the Air-cooled Condenser.* Check, clean and replace the filter at the air inlet of the air-cooled condenser coil inspect and clean the fan blades, as needed.
- Inspecting the control panel**
Check for loose wires, burned contacts, and signs of overheated wires. Check that all panel lights illuminate. *See Maintenance section entitled, Checking Electrical Connections.*
- Checking refrigerant charge**
With the compressor running, check the sight glass between the receiver and evaporator for proper refrigerant condition. *See Maintenance section entitled, Checking Refrigerant Charge.*
- Cleaning the Evaporator and Condenser “Y” strainer**
See Maintenance section entitled, Cleaning the Evaporator and Condenser “Y” Strainer.

Annually

- Cleaning the evaporator or air-cooled condenser**
See Maintenance sections entitled, Cleaning the Brazed Plate Evaporator or Water-cooled Condenser and Cleaning the Air-cooled Condenser.
- Check refrigerant piping**
Verify that no oil is present on fittings or cabinet. Wipe clean and check charge/operation of circuit.

To maintain the best performance, follow the maintenance schedule and record information in the Maintenance Log in Appendix B.

Checking Electrical Connections

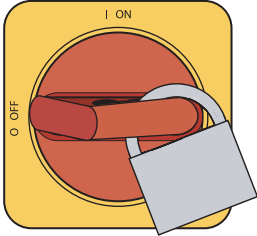

IMPORTANT: Always refer to the wiring diagrams that came with your chiller to locate specific electrical components. Illustrations in the User Guide are intended to be representative only.



WARNING: Electrical Hazard

Before performing any work on this item, disconnect and lock out electrical power sources to prevent injury from unexpected energization or startup. Be sure that power to the chiller is OFF when doing any maintenance on the chiller. Follow all safety rules when performing any maintenance on this equipment.



WARNING: Improper installation, operation or servicing may result in equipment damage or personal injury.

This equipment should only be installed, adjusted and serviced by a qualified technician personnel who is familiar with the construction, operation and potential hazards of this type of machine.

All wiring, disconnects and fuses should be installed by a qualified electrical technician in accordance with electrical codes in your region.

- 1 Be sure the main power is disconnected** and/or the chiller's optional disconnect switch is locked out. Always disconnect and lockout the main power source before opening the unit for servicing.
- 2 Open the electrical enclosure.**
- 3 Inspect all wires and connections.** Look for loose wires, burned contacts and signs of over-heated wires. Compare the wiring to the wiring diagrams you received with your chiller. Have a qualified electrician make any necessary repairs or replacements.
- 4 Close the electrical enclosure door.**
- 5 Inspect the exterior power cords.** Cords should not be crimped, exposed or rubbing against the frame. If the main power cord runs along the floor, make sure it is positioned where it could not rest in pooling water or could not be ran over and cut by wheels or casters.

Cleaning the Brazed Plate Evaporator or Water-cooled Condenser

Minerals and other contaminants produce deposits, scales, slime or algae on heat transfer surfaces exposed to water. Fouled surfaces result in decreased cooling capacity. Implement a water treatment program to slow the fouling.



CAUTION: Hot Surfaces

Always protect yourself from hot surfaces when working on the chiller, especially when working on or around the compressor and condenser. These devices can reach up to 160°F {71°C}. Allow these devices to cool before performing any maintenance or troubleshooting.

Water quality should be maintained at a pH level of 7.4, but not less than 6.0 for proper heat exchanger life.

To clean the brazed plate adapter:

- 1 Disconnect and lock out main power.**
- 2 Remove the chiller's side panels.**
- 3 Prepare a 5% solution of Phosphoric acid or Oxalic acid and water.** Do not heat the acid solution.
- 4 If cleaning the evaporator, shut the “To” and “From Process” valves and the drain reservoir.** *See Installation section entitled, Drain Connection.*
- 4b If cleaning the condenser, close the condenser inlet and outlet valves and drain the condenser piping.**
- 5 If cleaning the evaporator, disconnect the pump from the heat exchanger.**
Install a cap in the opening of the heat exchanger where the pump was connected.
- 5b If cleaning the condenser, disconnect piping to the condenser.** Install a cap in the opening of the condenser where the piping was connected.



NOTE: All brazed plate heat exchangers are copper and stainless steel.



NOTE: EarthSmart Chiller models 1.5, 3 and 5 have Tube-in-Tube style heat exchangers made with copper and steel. Follow recommended guidelines of the cleaning solution supplier for mixtures based upon the severity of fouling.



NOTE: These connections may vary depending on the model you have purchased. Be sure to see the labeling on your particular unit.

(continued)

Cleaning the Brazed Plate Evaporator or Water-cooled Condenser (continued)



CAUTION: Hot Surfaces

Always protect yourself from hot surfaces when working on the chiller, especially when working on or around the compressor and condenser. These devices can reach up to 160°F {71°C}. Allow these devices to cool before performing any maintenance or troubleshooting.



NOTE: All brazed plate heat exchangers are copper and stainless steel.



NOTE: EarthSmart Chiller models 1.5, 3 and 5 have Tube-in-Tube style heat exchangers made with copper and steel. Follow recommended guidelines of the cleaning solution supplier for mixtures based upon the severity of fouling.



NOTE: These connections may vary depending on the model you have purchased. Be sure to see the labeling on your particular unit.

6 Remove RTD from bottom of evaporator or condenser.

7 For the evaporator, connect 1/2-inch tubing to the 1/2-inch connections of the heat exchanger. SEE below to install customer supplied chemical pump and solution fitted to the heat exchanger.

7b For the condenser, remove 3/8 inch heat exchanger plug to drain. Connect as shown below and back flush. SEE below to install customer supplied chemical pump and solution fitted to the heat exchanger.

8 Back-flush the solution through the heat exchanger and the chiller.

9 Flush the heat exchanger and the chiller piping with fresh water after cleaning.

10 Reconnect the chiller pump to the heat exchanger. Remove the cap in the heat exchanger and reconnect the hose from the pump.

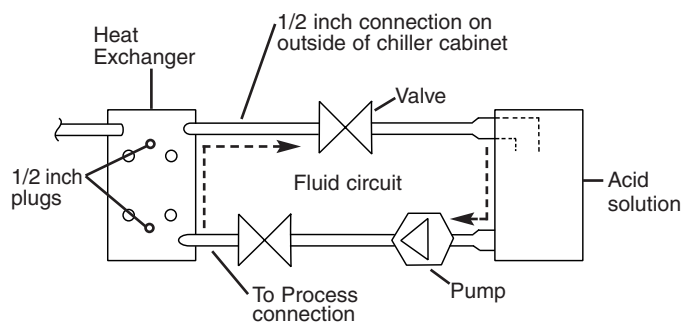

Cleaning the Brazed Plate Evaporator or Water-cooled Condenser (continued)



CAUTION: Hot Surfaces

Always protect yourself from hot surfaces when working on the chiller, especially when working on or around the compressor and condenser. These devices can reach up to 160°F {71°C}. Allow these devices to cool before performing any maintenance or troubleshooting.

- 11** Re-install the RTD for the evaporator or condenser.
- 12** For the evaporator, open the “To Process” and “From Process” valves (factory optional)
- 12b** For the condenser, open the condenser inlet and outlet valves.
- 13** Replace the chiller’s side panels.
- 14** Reapply main power.



NOTE: These connections may vary depending on the model you have purchased. Be sure to see the labeling on your particular unit.

Cleaning the Air-Cooled Condenser

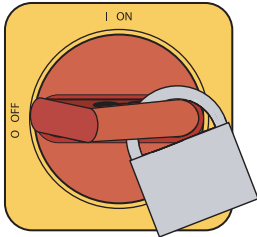

Replacement air filters are available from Conair.

Contact Conair Parts
(800) 458 1960
From outside of the
United States, call:
(814) 437 6861

 **NOTE:** Conair recommends cleaning the air-cooled chiller's exhaust fan blades when cleaning the filter.



WARNING: Electrical Hazard

Before performing any work on this item, disconnect and lock out electrical power sources to prevent injury from unexpected energization or startup. Be sure that power to the chiller is OFF when doing any maintenance on the chiller. Follow all safety rules when performing any maintenance on this equipment.



CAUTION: Hot Surfaces

Always protect yourself from hot surfaces when working on the chiller, especially when working on or around the compressor and condenser. These devices can reach up to 160°F {71°C}. Allow these devices to cool before performing any maintenance or troubleshooting.

The air-cooled condenser can accumulate dirt and clog quickly if it is ran in a dusty or dirty environment. A clogged condenser increases refrigerant discharge pressure, lowers performance, and may cause the fan motor(s) and compressor to overheat.

To clean the air-cooled condenser:

- 1 Disconnect and lockout power to the chiller.**
- 2 Remove the wire mesh air filter that is located on the side of the chiller by lifting up and out.**

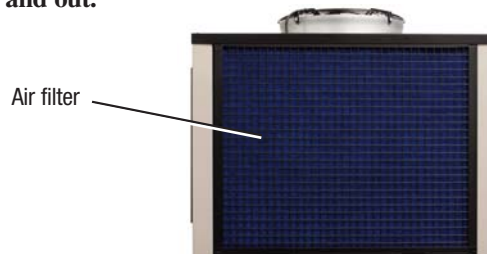

- 3 Inspect the coils.** Use a flashlight to check between coil surfaces.
- 4 Clean the dirty coils with a soft brush or vacuum.**
- 5 Flush with cool water or a commercial coil cleaner that is compatible with aluminum alloys.** Conair recommends spraying the coil cleaner from inside the chiller's cabinet.
- 5 Inspect and clean the air filter.** Replace as needed.



CAUTION: Wear eye protection.

If you use compressed air to clean the equipment, you must wear eye protection and observe all OSHA and other safety regulations pertaining to the use of compressed air.

Checking the Refrigerant Charge and Quality

WARNING: Refrigerant hazard

Only certified refrigerant technicians should examine and correct problems involving the refrigerant circuit.

 **CAUTION:** Always disconnect and lock out the main power sources before making electrical connections. Electrical connections should be made only by a qualified electrical technician.

All chillers are fully charged with R-410A refrigerant from Conair. Your chiller's model nameplate identifies the type and amount of total refrigerant charge required. *See Description section entitled, Specifications: EarthSmart ECW and ECA Series.*

Check refrigerant charge while the chiller is running under normal load. Check the refrigerant charge through the sight glass. Use a flashlight, if necessary, and check the liquid-line sight glass:

- **Under full load conditions**, the refrigerant should be clear (no bubbles).
- **Under low load conditions**, when the Hot-Gas Bypass valve (HGBP) is operating, bubbles may be visible in the sight glass. This is normal.

If the charge is low and the chiller is under warranty, contact Conair service; or have a local, certified refrigeration technician add R-410A refrigerant to the system.

A refrigerant quality label is located within the sight glass. A green label is normal. A yellow or dark brown label indicates that the refrigerant is contaminated.

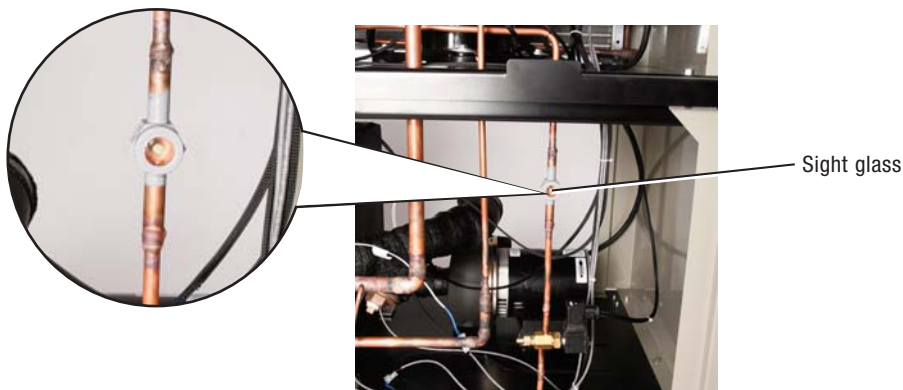

Checking the Compressor's Oil Level (Models ECW 7.5 and higher)



WARNING: Electrical Hazard

Before performing any work on this item, disconnect and lock out electrical power sources to prevent injury from unexpected energization or startup. Be sure that power to the chiller is OFF when doing any maintenance on the chiller. Follow all safety rules when performing any maintenance on this equipment.



CAUTION: Hot Surfaces

Always protect yourself from hot surfaces when working on the chiller, especially when working on or around the compressor and condenser. These devices can reach up to 160°F {71°C}. Allow these devices to cool before performing any maintenance or troubleshooting.

During normal operation, the EarthSmart compressor oil level should be between 1/8 and 1/2 full, and when at rest or in Stop mode the oil level should be 1/8 to 3/4 full.

To check the compressor's oil level:

- 1 Disconnect and lockout power to the chiller.**
- 2 Remove the left-side panel. (As viewed from the control)**
- 3 Locate the compressor,** it is positioned in the upper compartment of the chiller's cabinet.
- 4 Locate the compressor's sight glass.** The sight glass is positioned on the bottom of the compressor.

Checking the Compressor's Oil Level (Models ECW 7.5 and higher) (continued)



- 5 Check the compressor's oil level.** If no oil is visible, use a flashlight and look for bubbles rising in the sight glass. This may be an indication of liquid refrigerant in the compressor or the compressor is overfilled with oil.
- 6 Contact Conair Service or a certified refrigerant technician** if the compressor oil level is below the recommended limits or if bubbles are visible in the sight glass.
- 7 Replace the right-side panel.**
- 8 Reapply main power to the chiller.**

IMPORTANT: Attempting to service the compressor will void any warranty.

Checking the Hot-gas Bypass Valve Operation



WARNING: Electrical Hazard

Before performing any work on this item, disconnect and lock out electrical power sources to prevent injury from unexpected energization or startup. Be sure that power to the chiller is OFF when doing any maintenance on the chiller. Follow all safety rules when performing any maintenance on this equipment.



CAUTION: Hot Surfaces

Always protect yourself from hot surfaces when working on the chiller, especially when working on or around the compressor and condenser. These devices can reach up to 160°F {71°C}. Allow these devices to cool before performing any maintenance or troubleshooting.



IMPORTANT: Always refer to the wiring diagrams that came with your chiller to locate specific electrical components. Illustrations in the User Guide are intended to be representative only.

The Hot-gas Bypass valve (HGBP) is used as a heating element to maintain the user-entered setpoint temperature of the EarthSmart Chiller's process fluid. The HGBP valve allows refrigerant to bypass the chiller's condenser where heat is removed. Refrigerant is introduced to the evaporator to heat the process fluid providing consistent chiller temperatures. If the HGBP valve is closed, 100% cooling capacity is used to reduce or maintain temperature.

To check the Hot-gas Bypass valve's functionality:

1 Remove the left-side panel. (As viewed from the control)

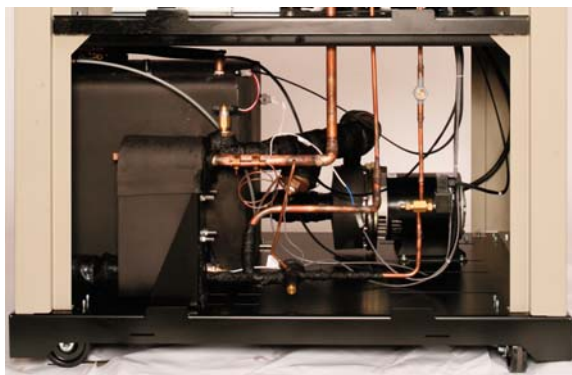

Checking the Hot-gas Bypass Valve Operation (continued)

- 2** Locate the TXV and follow the refrigerant piping to the evaporator. The Hot-gas Bypass line is the piping running down from the upper portion of the chiller's cabinet between the evaporator and TXV.

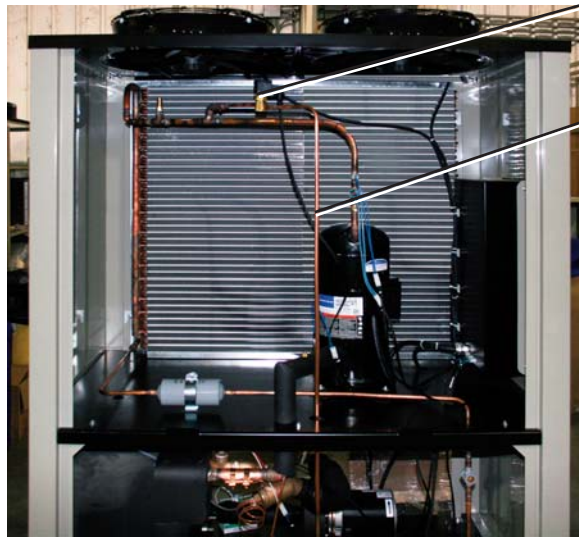

Hot-gas
Bypass valve

Hot-gas
Bypass line



IMPORTANT: Always refer to the wiring diagrams that came with your chiller to locate specific electrical components. Illustrations in the User Guide are intended to be representative only.

- 3** During operation the bypass LED on the chiller's control panel will pulse on and off indicating that the valve is being energized. There should also be a 'click' from the valve and refrigerant flowing (hissing sound) to the evaporator.
- 4** Measure the temperature of the Hot-gas Bypass line as the valve is energized. If the valve is functioning properly, there should be a noted temperature rise from when the valve is off to when it is energized.
- 5** Verify that the Hot-gas Bypass valve coil is functioning correctly and that power is reaching the coil when the bypass LED is energized, if no sign of refrigerant flow or temperature change has been detected. See the chiller's electrical wiring diagram.
- 6** Contact Conair Service or a certified refrigerant technician to replace the Hot-gas Bypass valve, if the valve is damaged or not functioning properly.

IMPORTANT: Attempting to service the Hot-gas Bypass valve will void any warranty.

Cleaning the Evaporator and Condenser “Y” Strainer (Air and Water-cooled)



WARNING: Electrical Hazard

Before performing any work on this item, disconnect and lock out electrical power sources to prevent injury from unexpected energization or startup. Be sure that power to the chiller is OFF when doing any maintenance on the chiller. Follow all safety rules when performing any maintenance on this equipment.



CAUTION: Hot Surfaces

Always protect yourself from hot surfaces when working on the chiller, especially when working on or around the compressor and condenser. These devices can reach up to 160°F {71°C}. Allow these devices to cool before performing any maintenance or troubleshooting.

The EarthSmart Chiller’s “Y” strainer(s) can accumulate dirt and clog quickly if it is ran in a poor water quality environment; which will cause poor chiller performance.

To clean the evaporator “Y” strainer (Air and Water-cooled):

- 1 Disconnect and/or lockout power to the chiller.**
- 2 Shut off the “To Process” and “From Process” valves (factory optional).**
- 3 Open the Fill/Drain valve.** Close the valve when the water level gauge on the back of the chiller reads half full.
- 4 Remove the left-side panel. (As viewed from the control)**

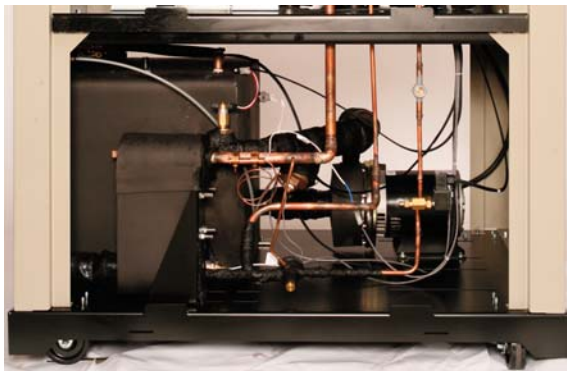

(continued)

Cleaning the Evaporator and Condenser “Y” Strainer (continued) (Air and Water-cooled)

5 Locate the evaporator “Y” strainer at the discharge of the Evaporator pump.

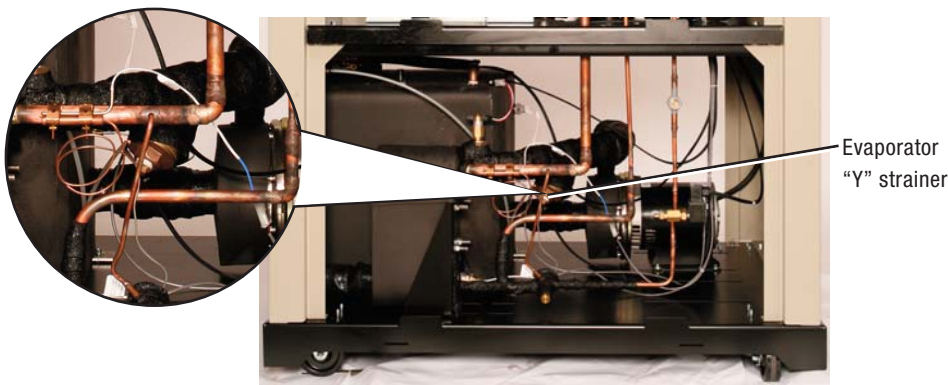

6 Remove the center plug from the cap to drain any water in the strainer, by using an appropriately-sized pipe wrench.

7 Remove the strainer from the strainer housing.

8 Inspect the strainer. Check for holes tears or filter blinding, clean or replace as necessary.

9 Re-install the strainer and strainer cap. Properly seal all piping with approved Teflon tape or pipe dope.

IMPORTANT: Check to ensure the strainer is properly seated before applying the strainer cap. Crushing of the strainer can occur if it is not fully inserted back into the strainer housing.

10 Check to ensure no leaking has occurred before returning the chiller to normal operation.

Replacement “Y” strainers are available from Conair.

Contact Conair Parts
(800) 458 1960
From outside of the
United States, call:
(814) 437 6861

(continued)

Cleaning the Evaporator and Condenser “Y” Strainer (continued)

(Water-cooled only)



WARNING: Electrical Hazard

Before performing any work on this item, disconnect and lock out electrical power sources to prevent injury from unexpected energization or startup. Be sure that power to the chiller is OFF when doing any maintenance on the chiller. Follow all safety rules when performing any maintenance on this equipment.



CAUTION: Hot Surfaces

Always protect yourself from hot surfaces when working on the chiller, especially when working on or around the compressor and condenser. These devices can reach up to 160°F {71°C}. Allow these devices to cool before performing any maintenance or troubleshooting.

The EarthSmart Chiller’s “Y” strainer can accumulate dirt and clog quickly if it is ran in a poor water quality environment; which will cause poor chiller performance.

To clean the condenser “Y” strainer (Water-cooled only):

- 1 Disconnect and/or lockout power to the chiller.**
- 2 Shut off water flow to the condenser inlet and outlet valves (factory optional).**
- 3 Remove the right-side panel.** (As view from the control)
- 4 Locate the “Y” strainer at the inlet of the condenser.**

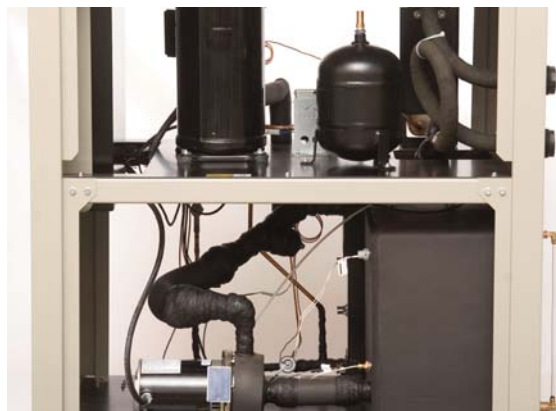

(continued)

Cleaning the Evaporator and Condenser “Y” Strainer (continued) (Water-cooled only)

5 Locate the evaporator “Y” strainer at the discharge of the condenser.

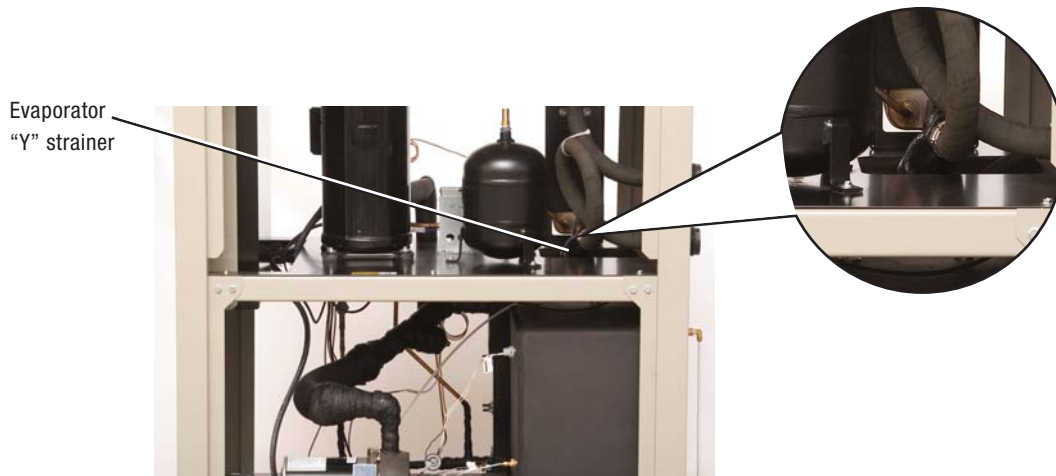

6 Remove the center plug from the cap to drain any water in the strainer, by using an appropriately-sized pipe wrench.

7 Remove the strainer from the strainer housing.

8 Inspect the strainer. Check for holes tears or filter blinding, clean or replace as necessary.

9 Re-install the strainer and strainer cap. Properly seal all piping with approved Teflon tape or pipe dope.

IMPORTANT: Check to ensure the strainer is properly seated before applying the strainer cap. Crushing of the strainer can occur if it is not fully inserted back into the strainer housing.

10 Check to ensure no leaking has occurred before returning the chiller to normal operation.

Replacement “Y” strainers are available from Conair.

Contact Conair Parts
(800) 458 1960
From outside of the
United States, call:
(814) 437 6861

Checking or Cleaning the Flow Switch

WARNING: Electrical Hazard

Before performing any work on this item, disconnect and lock out electrical power sources to prevent injury from unexpected energization or startup. Be sure that power to the chiller is OFF when doing any maintenance on the chiller. Follow all safety rules when performing any maintenance on this equipment.

CAUTION: Hot Surfaces

Always protect yourself from hot surfaces when working on the chiller, especially when working on or around the compressor and condenser. These devices can reach up to 160°F {71°C}. Allow these devices to cool before performing any maintenance or troubleshooting.

The EarthSmart Chiller's flow switch can accumulate dirt and deposits and give inaccurate water flow readouts in a poor water quality environment. Periodically check the flow switch when Flow Switch Failure (FSL) alarms become more apparent.

To check and/or clean the flow switch:

- 1 Disconnect and/or lockout power to the chiller.**
- 2 Shut off the “To Process” and “From Process” valves (factory optional).**
- 3 Open the Fill/Drain valve.** Close the valve when the water level gauge on the back of the chiller reads half full.
- 4 Remove the left-side panel. (As view from the control)**

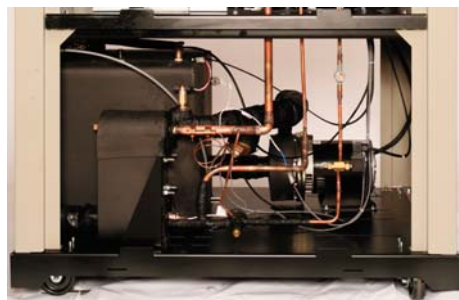

(continued)

Checking or Cleaning the Flow Switch (continued)

- 5 Remove the two (2) screws at the top of the switch.** Ensure to mark the position of the circuit selection switch located on top of the switch, “NO” (normally-open).

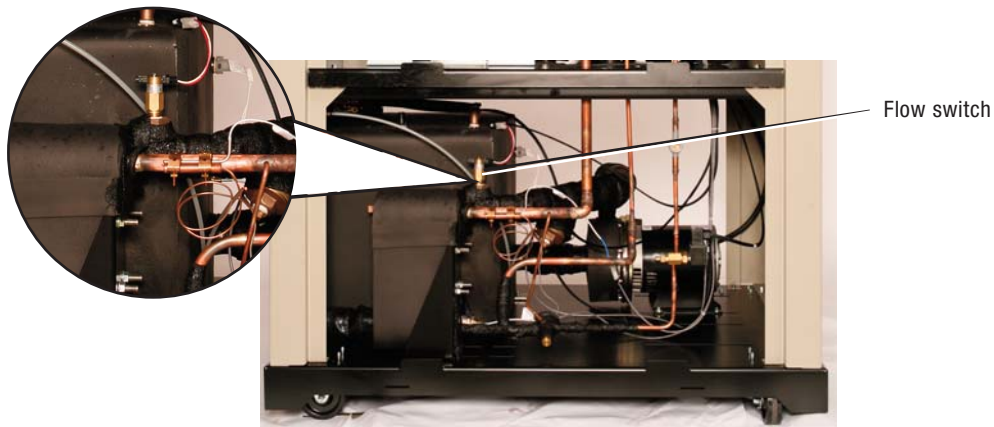

- 6 Unscrew the switch from the piping with an appropriately-sized wrench.** Note the arrow direction on the side of the switch before removing, the switch **must** be installed back into this location.
- 7 Inspect and clean the switch** by tapping the paddle on a hard surface. This will loosen debris in the upper housing so the paddle will move again and/or spray with lubricant to free up moving parts, or replace as necessary.
- 8 Apply Teflon tape or pipe dope to the switch threads and re-insert THE switch into the piping** with proper flow direction.
- 9 Re-install electrical hardware to the switch** and fill the reservoir and open the “To Process” and “From Process” valves (factory optional).
- 10 Reapply main power to the chiller** to test the switch.

Replacement flow switches are available from Conair.

Contact Conair Parts
(800) 458 1960
From outside of the
United States, call:
(814) 437 6861

Checking Reservoir Level

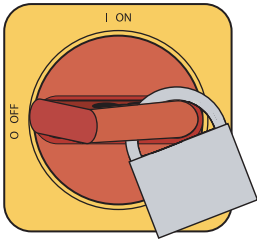

WARNING: Electrical Hazard

Before performing any work on this item, disconnect and lock out electrical power sources to prevent injury from unexpected energization or startup. Be sure that power to the chiller is OFF when doing any maintenance on the chiller. Follow all safety rules when performing any maintenance on this equipment.

Check the fluid level in the reservoir. The read-out in the sight glass on the back of the chiller should be 3/4 full.

To manually fill the reservoir:

- 1 Disconnect and/or lockout power to the chiller.**
- 2 Locate the Fill/Drain valve on the back of the chiller and open the valve.**
- 3 Refill the reservoir.** Monitor the level using the water level indicator on the back of the chiller. Because the EarthSmart Chiller can use either pure water or a glycol/water mixture, make sure you are adding the correct fluid for your application. *See Installation section entitled, Filling the Chiller.*

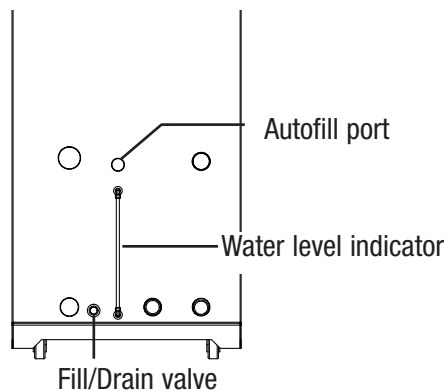

IMPORTANT: When using a glycol mixture, the use of the optional Autofill function is **not** recommended.

Checking Pump Performance



CAUTION: Hot Surfaces

Always protect yourself from hot surfaces when working on the chiller, especially when working on or around the compressor and condenser. These devices can reach up to 160°F {71°C}. Allow these devices to cool before performing any maintenance or troubleshooting.

Checking your EarthSmart Chiller's pump performance ensures that the motor pump is operating properly. Proper operation of the motor pump maintains correct water pressure to your process, which allows cooling of your system.

To check motor pump performance:

- 1 Check the difference between the pump discharge pressure at the “To Process connection (inline pressure gauge not included) and the pressure at the inlet of the evaporator.**
- 2 Plot the discharge pressure from the “To Process” connection on the pump curve that is specific to your model chiller, *see Description section entitled, Pump Curves.*** The pump curves will indicate the flow of the process fluid in gallons per minute.
- 3 Check the pump motor's full load amp usage.** Typically, the pump motor will be running at 80% or higher of its full load amp (FLA) rating. If the pump's FLA rating is below 80%, there may be low process fluid flow. *See Installation section entitled, Checking Pump Rotation.*
- 4 Check pump impeller performance, if the pump motor's rotation is correct, by shutting off the “To Process” valve (factory optional) during operation. Note the “To Process” pressure from the pump and reference this number (0 gpm) on the pump curve, *see Description section entitled, Pump Curves.*** If there is no significant difference between the pump curve pressure and the actual pressure, the pump impeller is operating properly. If there is a difference of 5 psig or more between the actual pressure and the pump curve readout, replace the pump. *See Troubleshooting section entitled, Replacing Pump Components.*



NOTE: When using the motor pump in the pump tank, the “From Process” water pressure is determined by the height above the inlet. Add 1 psi for every 2.31 ft {70.4 cm} above the inlet.

Replacement motor pumps and water pressure gauges are available from Conair.

Contact Conair Parts
(800) 458 1960
From outside of the
United States, call:
(814) 437 6861

Reloading Factory Default Parameters

❖ **TIP:** Pressing and holding the “Scroll” button while pressing the “Function” button will increase menu navigation speed.

Reloading the factory default parameters should only be performed when all other troubleshooting methods have been attempted. Reloading default parameters will reset **all** parameters except: Run Times, PID Values, Cycle Counters, Controller Option Type, Chiller Type, Autofill Option and Hot-gas Bypass valve present.

To reload all factory default parameters:

1 Enter the Supervisor’s password within the Setup Menu Branch. *See Operation section entitled, Using Supervisor’s Password.*

FUNC

2 Press the “Function” button to save the password entry and exit to the Main Menu.



FUNC

3 Press and release both the “Scroll” and “Function” buttons together until the main screen of the Setup Menu (Screen 82) is displayed.

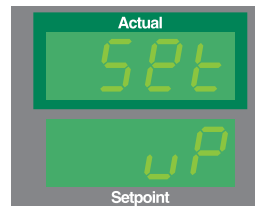

4 Press the “Scroll” button until the Load Default screen (Screen 95) is displayed.

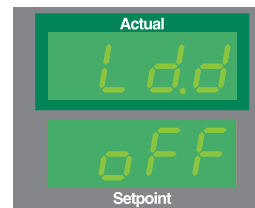

5 Use the (+) or (-) buttons to turn the Load Default on or off.



6 Press the “Scroll” button to lock in the selection or press the “Function” button to lock in the selection and exit to the Main Menu.

7 Error code “0297” will be shown in the chiller’s display. This is normal after resetting factory defaults.

8 Restart the chiller’s control to resume normal operation.

Troubleshooting

Before beginning	6-2
Identifying the cause of a problem	6-2
A few words of caution	6-3
<u>TROUBLESHOOTING</u>	
Chiller problems	6-4
Autotuning errors	6-6
Passive alarms	6-8
Shut down alarms	6-13
Additional alarms	6-20
Replacing the RTD	6-22
Removing pump components	6-23
Replacing the contactor	6-24

Before Beginning

You can avoid most problems by following the recommended installation, operation and maintenance procedures outlined in this User Guide. If you have a problem, this section will help you determine the cause and tell you how to fix it.

Before you begin troubleshooting:

- ❑ Find any wiring, piping and assembly diagrams that were shipped with your equipment. These are the best references for correcting a problem. The diagrams will note any custom features or options not covered in this User Guide.
- ❑ Check that you have manuals for other equipment connected in the system. Troubleshooting may require investigating other equipment attached to, or connected with the chiller.

Identifying the Cause of a Problem

The Troubleshooting section covers problems directly related to the operation and maintenance of the EarthSmart Chiller.

Types of conditions you may see include control problems (not lighting, or lighting and not running) and alarm conditions (passive or shut down).

When the alarm light is displayed:



- 1 Note the alarm and press the “Acknowledge Alarm” button once to silence the optional audible and visual alarms and display the alarm message, if still active.**
- 2 Find the error message in the diagnostics table of this *Troubleshooting section*. Use information provided to diagnose and resolve the cause of the alarm.**
- 3 Note that, after correcting the problem, pressing the “Acknowledge Alarm” button a second time will clear the alarm.** If the alarm reappears, the cause has not been resolved.

A Few Words of Caution

 **WARNING: Improper installation, operation or servicing may result in equipment damage or personal injury.**

This equipment should only be installed, adjusted and serviced by a qualified technician who is familiar with the construction, operation and potential hazards of this type of machine.

All wiring, disconnects and fuses should be installed by a qualified electrical technician in accordance with electrical codes in your region.

 **WARNING: Electrical Hazard**

Before performing any work on this item, disconnect and lock out electrical power sources to prevent injury from unexpected energization or startup. Be sure that power to the chiller is OFF when doing any maintenance on the chiller. Follow all safety rules when performing any maintenance on this equipment.

 **CAUTION: Hot Surfaces**

Always protect yourself from hot surfaces when working on the chiller, especially when working on or around the compressor and condenser. These devices can reach up to 160°F {71°C}. Allow these devices to cool before performing any maintenance or troubleshooting.

 **WARNING: Refrigerant Hazard**

Only a certified refrigerant technician should examine and correct problems involving the refrigerant circuit.

Chiller Problems

Look here if the control panel is not lit, or if the power is on and the EarthSmart Chiller will not run.

Symptom	Possible cause	Solution
<p>The control is not lit and the chiller is not working.</p>	Power is not reaching the chiller.	<p>Check the power cord and plug. Make sure the cord and plug are properly connected.</p> <p>Ensure that the optional disconnect switch is in the “On” position.</p> <p>Check fuses, breakers and power supplies. Replace or reset as necessary.</p>
	Interconnecting control ribbon cable is loose or disconnected.	Resecure control cable, ensure the main board’s LED is flashing.
	The correct power is not reaching the unit.	Check the voltage specification on the chiller nameplate. <i>See Description section entitled, Specifications: EarthSmart ECW and ECA Series.</i>
	There is a problem with the control panel.	The control panel may have failed. Contact Conair Service.
<p>The control is not lit and there is no alarm condition. The compressor hums, but does not run.</p>	The input voltage is incorrect.	Check the main supply voltage. It must be within 10% of the nameplate rating.
	There is a phase loss and/or the compressor’s contactor is welded shut.	<p>Check the phase-to-phase voltages.</p> <p>Check the phase continuity through the compressor contactor.</p> <p>Check the wiring at the compressor. Replace or repair as needed.</p> <p>The motor starter protector is damaged. Replace the motor starter, <i>see Appendix J entitled, Motor Protection.</i></p>

Chiller Problems

Symptom	Possible cause	Solution
<p>The compressor LED on the control panel is lit, but the compressor is not running.</p>	<p>The compressor's overload has been tripped.</p>	<p>Reset and properly adjust the compressor overload.</p>
	<p>The compressor contactor is damaged or defective.</p>	<p>Replace the contactor. <i>See Troubleshooting section entitled, Replacing the Contactor.</i></p>
	<p>The compressor module is defective or damaged. (EarthSmart Chillers, Models 15 tons and above)</p>	<p><i>See Appendix I entitled, Compressor Module Troubleshooting.</i></p>
	<p>Internal compressor motor protector has tripped. (EarthSmart Chillers, Models 10 tons and below)</p>	<p>Recycle the power and allow the chiller to sit idle for up to one hour.</p>
<p>The Hot-gas Bypass valve (HGBP) LED is lit, but the valve is not energized.</p>	<p>Loose wiring connections to the HGBP valve.</p>	<p>Check interconnecting wiring, resecure as necessary.</p>
	<p>Damaged or defective HGBP valve coil.</p>	<p><i>See Maintenance section entitled, Checking the Hot-gas Bypass Valve Operation.</i></p>

Autotuning Errors

Listed below are possible errors that may be displayed when attempting an Autotune cycle.

Symptom	Possible cause	Solution
<div style="border: 1px solid black; padding: 2px; width: fit-content; margin-bottom: 5px;">tune</div> <div style="border: 1px solid black; padding: 2px; width: fit-content;">err2</div>	The Hot-Gas Bypass valve (HGBP) is not affecting the process fluid. (Damaged Hot-gas Bypass valve, coil or clogged valve)	Have a certified refrigeration technician replace the valve.
<div style="border: 1px solid black; padding: 2px; width: fit-content; margin-bottom: 5px;">tune</div> <div style="border: 1px solid black; padding: 2px; width: fit-content;">err3</div>	The temperature deviation between the user-entered temperature setpoint and the actual process temperature is less than 20°F {11.1°C}.	Exit the Autotune cycle and restart with a lower process temperature setpoint. <i>See Operation section entitled, Adjusting Setpoint Temperature.</i>
<div style="border: 1px solid black; padding: 2px; width: fit-content; margin-bottom: 5px;">tune</div> <div style="border: 1px solid black; padding: 2px; width: fit-content;">err5</div>	Maximum time allowed for an Autotune cycle (15 minutes) has expired.	Exit the Autotune cycle and restart.

Autotuning Errors (continued)

Listed below are possible errors that may be displayed when attempting an Autotune cycle.

Symptom	Possible cause	Solution
tune	The Autotune failed to calculate a meaningful response of the system.	Exit the Autotune cycle and restart.
err6	PID settings are not within their default ranges.	Exit the Autotune cycle and restart.
	Chiller system has no consistency.	<i>See Operation section entitled, Autotuning Requirements.</i>
	Poor water flow.	Check to ensure that all water inlet and outlet valves are in the opened position.
	Hot-gas Bypass valve temperatures are varying.	<i>See Maintenance section entitled, Checking the Hot-gas Bypass valve Operation.</i>

Passive Alarms

During a passive alarm the chiller continues to operate, but if ignored, could lead to a condition that will shut down the chiller.



 **NOTE:** Passive alarms are controlled by the Process Variable Selection, Screen 27. *See Operation section entitled, Adjusting the Process Variable Selection.*

Symptom	Possible cause	Solution
<p>Autofill Failure (optional)</p> <div style="border: 1px solid black; padding: 5px; width: fit-content; margin-bottom: 5px;">LSH</div> <div style="border: 1px solid black; padding: 5px; width: fit-content; margin-bottom: 5px;">HH.MM</div> <p> NOTE: An Autofill Failure Alarm (LSH) turns the Autofill valve off.</p>	<p>The inlet valve for the process fluid is closed.</p> <p>Leak in the reservoir tank.</p> <p>Damaged water inlet hose.</p> <p>Water pressure is low.</p> <p>Reservoir float level switch is stuck closed or has loose or damaged wiring.</p> <p>The float level switch is improperly installed or is damaged.</p>	<p>Open the process fluid inlet valve.</p> <p>Check and/or replace reservoir tank.</p> <p>Replace inlet hose.</p> <p>Increase water pressure or check to ensure water inlet valve is fully opened.</p> <p>Increase Autofill Delay Time. <i>See Operation section entitled, Adjusting the Autofill Timer (optional).</i></p> <p>Check and/or clean the float level switch. <i>See Appendix H entitled, Cleaning the Autofill Valve.</i></p> <p><i>Check the float level switch. See Appendix G entitled, Installing Autofill (optional).</i></p>
<p>Evaporator RTD Failure</p> <div style="border: 1px solid black; padding: 5px; width: fit-content; margin-bottom: 5px;">tE3F</div> <div style="border: 1px solid black; padding: 5px; width: fit-content; margin-bottom: 5px;">HH.MM</div>	<p>Loose or disconnected RTD sensor on the evaporator.</p> <p>Damaged RTD sensor near the evaporator's suction piping.</p>	<p>Check the evaporator RTD sensor, tighten or reconnect as necessary.</p> <p>Replace evaporator RTD sensor. <i>See Troubleshooting section entitled, Replacing the RTD and Appendix F entitled, RTD Resistance Chart.</i></p>

Passive Alarms

During a passive alarm the chiller continues to operate, but if ignored, could lead to a condition that will shut down the chiller.

 **NOTE:** Passive alarms are controlled by the Process Variable Selection, Screen 27. *See Operation section entitled, Adjusting the Process Variable Selection.*

Symptom	Possible cause	Solution
<p>Process Temperature Switch High</p> <div style="border: 1px solid black; padding: 5px; width: fit-content; margin-bottom: 5px;">tSH</div> <div style="border: 1px solid black; padding: 5px; width: fit-content;">HH.MM</div> <p> NOTE: This alarm automatically clears when the alarm condition is resolved. Pressing the “Alarm Acknowledgement” button is not required. The alarm will be present in the Alarm Log.</p>	<p>Load too high for chiller.</p> <p>Initial process temperature is too high.</p> <p>User-entered process fluid temperature is too high.</p> <p>Refrigerant charge is too low.</p> <p>User-entered Process High Passive Alarm Setpoint (H.AL) is set too low.</p> <p>Process High Temperature Alarm Delay and Inhibit times are set too short.</p> <p>Hot-gas Bypass valve is stuck open.</p>	<p>Reduce the load on the chiller.</p> <p>Lower initial process fluid temperature.</p> <p>Lower user-entered process fluid temperature setpoint. <i>See Operation section entitled, Adjusting Setpoint Temperature.</i></p> <p><i>See Maintenance section entitled, Checking the Refrigerant Charge and Quality.</i></p> <p>Increase the Process High Passive Alarm Setpoint (H.AL). <i>See Operation section entitled, Adjusting the Process High Alarm Setpoint (H.AL).</i></p> <p>Increase the Process High Temperature Alarm Delay and Inhibit times. <i>See Operation sections entitled, Adjusting the Process High Inhibit Time (HA.i) and Adjusting the Process High Delay Time (HA.d).</i></p> <p><i>See Maintenance section entitled, Checking the Hot-gas Bypass Valve Operation.</i></p>
<p>“From Process” Temperature Element Failure</p> <div style="border: 1px solid black; padding: 5px; width: fit-content; margin-bottom: 5px;">tE2F</div> <div style="border: 1px solid black; padding: 5px; width: fit-content;">HH.MM</div>	<p>Damaged “From Process” RTD.</p> <p>Loose or damaged RTD connection.</p> <p> NOTE: This alarm is only passive when the chiller is controlling from “To Process”.</p>	<p>Replace the “From Process” RTD. <i>See Troubleshooting section entitled, Replacing the RTD.</i></p> <p>Check the RTD connection. Resecure as necessary.</p>

Passive Alarms

During a passive alarm the chiller continues to operate, but if ignored, could lead to a condition that will shut down the chiller.

 **NOTE:** Passive alarms are controlled by the Process Variable Selection, Screen 27. *See Operation section entitled, Adjusting the Process Variable Selection.*

Symptom	Possible cause	Solution
<p>Process Deviation High</p> <div style="border: 1px solid black; padding: 5px; width: fit-content; margin: 5px 0;">tdH</div> <div style="border: 1px solid black; padding: 5px; width: fit-content; margin: 5px 0;">HH.MM</div> <p> NOTE: This alarm automatically clears when the alarm condition is resolved. Pressing the “Alarm Acknowledgement” button is not require. The alarm will be present in the Alarm Log.</p>	<p>Load too high for chiller.</p> <p>Initial process temperature is too high.</p> <p>User-entered process fluid temperature is too high.</p> <p>Process Deviation High Setpoint is too low.</p> <p>The compressor is not running.</p> <p>Hot-gas Bypass valve is stuck open.</p> <p>Improper Autotune.</p> <p>Low airflow through the condenser. (Air-cooled only)</p>	<p>Reduce the load on the chiller.</p> <p>Lower initial process fluid temperature.</p> <p>Lower user-entered process temperature setpoint. <i>See Operation section entitled, Adjusting Setpoint Temperature.</i></p> <p>Increase Process Deviation High Setpoint. <i>See Operation section entitled, Adjusting the Process Deviation High Alarm Setpoint (dE.H).</i></p> <p>Replace the compressor.</p> <p>Verify that the compressor overload and wiring is installed properly. <i>See Appendix J entitled, Motor Protection.</i></p> <p>Check to ensure the valve is not clogged. <i>See Maintenance section entitled, Checking the Hot-gas Bypass Valve.</i></p> <p>Have a certified refrigeration technician replace the solenoid valve.</p> <p>Run the Autotune sequence again. <i>See Operation section entitled, Autotuning Requirements and Autotuning Procedure.</i></p> <p>Reload factory Autotune presets. <i>See Operation section entitled, Control Function Descriptions, Screens 13, 14, 15 and 16.</i></p> <p>Check and/or replace the air filter. <i>See Maintenance section entitled, Cleaning the Air-cooled Condenser.</i></p>

Passive Alarms

During a passive alarm the chiller continues to operate, but if ignored, could lead to a condition that will shut down the chiller.

 **NOTE:** Passive alarms are controlled by the Process Variable Selection, Screen 27. *See Operation section entitled, Adjusting the Process Variable Selection.*

Symptom	Possible cause	Solution
<p>Process Deviation High (continued)</p> <div style="border: 1px solid black; padding: 5px; width: fit-content; margin: 5px auto;">tdH</div> <div style="border: 1px solid black; padding: 5px; width: fit-content; margin: 5px auto;">HH.MM</div>	<p>Low water flow through the condenser. (Water-cooled only)</p> <p>Ambient air temperature is too high. (Air-cooled only, maximum 95°F {35°C})</p> <p>Condenser water inlet temperature is too high. (Water-cooled only, maximum 85°F {29.4°C})</p> <p>Improper TXV valve setting or operation.</p>	<p>Check and/or clean the water-cooled condenser. <i>See Maintenance sections entitled, Cleaning the Evaporator and Condenser “Y” Strainer and Cleaning the Braze Plate Evaporator and Water-cooled Condenser.</i></p> <p>Verify proper airflow around the chiller. Ensure there is no discharge air recirculation.</p> <p>Reduce condenser water inlet temperature.</p> <p>Have a certified refrigeration technician replace the valve.</p>
<p>Process Deviation Low</p> <div style="border: 1px solid black; padding: 5px; width: fit-content; margin: 5px auto;">tdL</div> <div style="border: 1px solid black; padding: 5px; width: fit-content; margin: 5px auto;">HH.MM</div> <p> NOTE: This alarm automatically clears when the alarm condition is resolved. Pressing the “Alarm Acknowledgement” button is not require. The alarm will be present in the Alarm Log.</p>	<p>Load too low for chiller.</p> <p>Damaged or clogged Hot-Gas Bypass valve (HGBP).</p> <p>Compressor cut-out setpoint is set too low.</p> <p>Process Deviation Low Setpoint is set too low.</p> <p>Process Deviation Low Inhibit Time set too low.</p> <p>Process Deviation Low Delay Time set too low.</p>	<p>Increase the load on the chiller.</p> <p>Have a certified refrigeration technician replace the solenoid valve.</p> <p>Adjust the compressor cut-out setpoint. <i>See Operation section entitled, Control Screen Descriptions, Screen 24.</i></p> <p>Increase the Process Deviation Low setpoint. <i>See Operation section entitled, Adjusting the Process Deviation Low Alarm setpoint (dE.L).</i></p> <p>Adjust the Process Deviation Low Inhibit Time setpoint. <i>See Operation section entitled, Adjusting the Process Deviation Low Alarm Inhibit Time (dE.i).</i></p> <p>Adjust the Process Low Delay Time setpoint. <i>See Operation section entitled, Adjusting the Process Deviation Low Alarm Delay Time (dE.d).</i></p>

Passive Alarms

During a passive alarm the chiller continues to operate, but warns of a problem that could prevent correct cooling of your process fluid. If ignored, this problem could lead to a condition that will shut down the chiller.

 **NOTE:** Passive alarms are control by the Process Variable Selection, Screen 27. [See Operation section entitled, Adjusting the Process Variable Selection.](#)

Symptom	Possible cause	Solution
<p>Process Temperature Switch Low</p> <div style="border: 1px solid black; padding: 5px; width: fit-content; margin: 5px auto;">tSL</div> <div style="border: 1px solid black; padding: 5px; width: fit-content; margin: 5px auto;">HH.MM</div> <p> NOTE: This alarm automatically clears when the alarm condition is resolved. Pressing the “Alarm Acknowledgement” button is not require. The alarm will be present in the Alarm Log.</p>	<p>Load too low for chiller.</p> <p>Initial process temperature is too low.</p> <p>User-entered process fluid temperature too low.</p> <p>Process Low Alarm Setpoint is set too high.</p> <p>Process Low Alarm Inhibit Time set too low.</p> <p>Process Low Alarm Delay Time set too low.</p> <p>Glycol usage not enabled.</p> <p>Water flow is too low.</p> <p>Faulty compressor contactor.</p>	<p>Increase the load on the chiller.</p> <p>Increase initial process fluid temperature.</p> <p>Increase user-entered process temperature setpoint. See Operation section entitled, Adjusting Setpoint Temperature.</p> <p>Lower the Process Low Alarm setpoint. See Operation section entitled, Adjusting the Process Low Alarm setpoint (LA.L).</p> <p>Adjust the Process Low Alarm Inhibit Time setpoint. See Operation section entitled, Adjusting the Process Low Alarm Inhibit Time (LA.i).</p> <p>Adjust the Process Low Alarm Delay Time setpoint. See Operation section entitled, Adjusting the Process Low Alarm Delay Time (LA.d).</p> <p>Enable glycol usage, see Operation section entitled, Glycol Operation Enable/Disable.</p> <p>Adjust water flow to your specific chiller model. See Description section entitled, Specifications: EarthSmart ECW and ECW Series.</p> <p>Verify that the compressor contactor disengages in Stop mode, replace as necessary.</p>

Shut Down Alarms

The chiller has automatically shut down because it has detected a serious problem that could damage your material or chiller.

Symptom	Possible cause	Solution
<p>Temperature Controller (Loop Break) Failure</p> <div style="border: 1px solid black; padding: 5px; width: fit-content; margin-bottom: 5px;">tCF</div> <div style="border: 1px solid black; padding: 5px; width: fit-content;">HH.MM</div>	<p>Hot-gas bypass valve is damaged or clogged.</p> <p>Load on the chiller is too high or low.</p> <p>Initial process fluid temperature is either extremely too high or low.</p> <p>Loop Break timer is set too low.</p> <p>Improper Autotune.</p>	<p>Have a certified refrigeration technician replace the solenoid valve.</p> <p>Reduce or increase the load on the chiller. Contact a Conair representative for correct chiller sizing for your process.</p> <p>Lower or increase the initial process fluid temperature to within normal operation conditions.</p> <p>Increase the Loop Break timer duration. <i>See Operation section entitled, Adjusting the Process Loop Break Timer (Lb.t).</i></p> <p>Re-tune the chiller. <i>See Operation section entitled, Autotuning Requirements and Autotuning Procedure.</i></p> <p>Reset factory defaults. <i>See Maintenance section entitled, Reloading Factory Default Parameters.</i></p>
<p>Flow Switch Loss</p> <div style="border: 1px solid black; padding: 5px; width: fit-content; margin-bottom: 5px;">FSL</div> <div style="border: 1px solid black; padding: 5px; width: fit-content;">HH.MM</div>	<p>At start-up, no water flow is detected.</p> <p>The chiller's pump is not operating.</p> <p>The chiller's pump motor starter has tripped.</p> <p>Incorrect pump rotation.</p>	<p>Check to ensure all water valves are open at the chiller and auxiliary equipment. <i>See Maintenance section entitled, Checking Pump Performance.</i></p> <p>Check to ensure the chiller's water reservoir is filled.</p> <p>Check the pump's functionality. <i>See Operation section entitled, Control Function Descriptions, Screen 100.</i></p> <p>Reset to proper pump full load amps or correct overload condition.</p> <p>Incorrect power phasing. <i>See Installation section entitled, Checking Pump Rotation.</i></p>

Shut Down Alarms

The chiller has automatically shut down because it has detected a serious problem that could damage your material or chiller.

Symptom	Possible cause	Solution
<p>Flow Switch Loss (continued)</p> <div style="border: 1px solid black; padding: 5px; width: fit-content; margin: 5px 0;">FSL</div> <div style="border: 1px solid black; padding: 5px; width: fit-content; margin: 5px 0;">HH.MM</div>	<p>Damaged or improperly installed flow switch.</p> <p>Clogged “Y” Strainer.</p> <p>The evaporator is frozen.</p> <p>Clogged or damaged pump impeller.</p>	<p><i>See Maintenance section entitled, Checking or Cleaning the Flow Switch.</i></p> <p><i>See Maintenance section entitled, Cleaning the Evaporator and Condenser “Y” Strainer.</i></p> <p>Stop the chiller and manually start the pump.</p> <p>Let the chiller stand in Stop mode until the evaporator thaws.</p> <p><i>See Maintenance section entitled, Checking Motor Performance.</i></p>
<p>Refrigeration Pressure Switch High</p> <div style="border: 1px solid black; padding: 5px; width: fit-content; margin: 5px 0;">PSH</div> <div style="border: 1px solid black; padding: 5px; width: fit-content; margin: 5px 0;">HH.MM</div> <p> NOTE: Manual resetting of the High Pressure switch is required to clear this alarm. <i>See Appendix M, entitled, Resetting the High Pressure Switch.</i></p>	<p>Load too high for chiller.</p> <p>The high side of the compressor is above 550 PSI. (Air-cooled only)</p> <p>The high side of the compressor is above 550 PSI. (Water-cooled only)</p> <p>Clogged or blocked condenser coils.</p> <p>Insufficient clearance around the chiller.</p> <p>Ambient air temperature is higher than 95°F {35°C}.</p> <p>Condenser water is above 85°F {29.4°C}.</p>	<p>Reduce the load on the chiller.</p> <p>Fan motors are damaged. Replace fan assembly.</p> <p>Fan overload has been tripped, reset overload.</p> <p>Reduce condenser water temperature.</p> <p><i>See Maintenance section entitled, Cleaning the Evaporator and Condenser “Y” Strainer.</i></p> <p>Clean condenser coils. <i>See Maintenance sections entitled, Cleaning the Air-cooled Condensers and Cleaning the Brazed Plate Evaporator or Water-cooled Condenser</i></p> <p>Increase clearance around the chiller. <i>See Installation section entitled, Preparing for Installation.</i></p> <p>Reduce ambient air temperature or move the chiller to a lower temperature environment.</p> <p>Reduce the temperature of the condenser water.</p>

Shut Down Alarms (continued)

The chiller has automatically shut down because it has detected a serious problem that could damage your material or chiller.

Symptom	Possible cause	Solution
Refrigeration Pressure Switch Low <div style="border: 1px solid black; padding: 5px; width: fit-content; margin: 5px auto;">PSL</div> <div style="border: 1px solid black; padding: 5px; width: fit-content; margin: 5px auto;">HH.MM</div>	<p>No or low flow with a failed flow switch and a faulty RTD.</p> <p>The evaporator is fouled.</p> <p>Evaporator frozen.</p> <p>Improper glycol mixture.</p> <p>Faulty TXV solenoid valve.</p> <p>Refrigerant leak.</p> <p>Condenser air or water too cold.</p> <p>Improper fan cycling pressure switch setting.</p>	<p>Check optional “To Process” and “From Process” valves to see if they are open.</p> <p>Check flow switch and RTD. Replace as necessary. <i>See Troubleshooting section entitled, Replacing the RTD and Maintenance section entitled, Checking or Cleaning the Flow Switch.</i></p> <p>Clean evaporator. <i>See Maintenance section entitled, Cleaning the Evaporator or Water-cooled Condenser.</i></p> <p>Check the flow switch, RTD and low temperature cutout on control. Replace as necessary. <i>See Troubleshooting section entitled, Replacing the RTD and Maintenance section entitled, Checking or Cleaning the Flow Switch.</i></p> <p>Re-adjust glycol mixture, <i>see Installation section entitled, Filling the Chiller.</i></p> <p>Check wiring, voltage, coil and relay (see electrical drawings); replace as needed.</p> <p>Check for oil in chiller cabinet and bubbles in refrigerant sight glass. <i>See Maintenance section entitled, Checking the Refrigerant Charge and Quality.</i></p> <p>Have a certified refrigeration technician service the chiller.</p> <p>Check air/water temperature. Water should be 75°F {23.8°C} or higher; air temperature should be 70°F {21.1°C} or higher.</p> <p>Re-adjust fan cycling pressure switch setting. <i>See Appendix L entitled, Pressure switch settings.</i></p>

Shut Down Alarms (continued)

The chiller has automatically shut down because it has detected a serious problem that could damage your material or chiller.

Symptom	Possible cause	Solution
<p>Refrigeration Pressure Switch Low (continued)</p> <div style="border: 1px solid black; padding: 5px; width: fit-content; margin: 5px auto;">PSL</div> <div style="border: 1px solid black; padding: 5px; width: fit-content; margin: 5px auto;">HH.MM</div>	<p>Wiring incorrect.</p> <p>Improperly adjusted Low Pressure Inhibit Time (LP.i).</p> <p>Improperly adjusted Low Pressure Delay Time (LP.d).</p>	<p>Use wiring diagrams and check wiring. Correct as needed.</p> <p>Re-adjust Low Pressure Inhibit Time, <i>see Operation section entitled, Adjusting the Low Pressure Inhibit Time (LP.i).</i></p> <p>Re-adjust Low Pressure Delay Time, <i>see Operation section entitled, Adjusting the Low Pressure Delay Time (LP.d).</i></p>
<p>“To Process” Temperature Element Failure</p> <div style="border: 1px solid black; padding: 5px; width: fit-content; margin: 5px auto;">tE1F</div> <div style="border: 1px solid black; padding: 5px; width: fit-content; margin: 5px auto;">HH.MM</div> <p> NOTE: This alarm is only passive when the chiller is controlling from “From Process”.</p>	<p>Damaged “To Process” RTD.</p> <p>Loose or damaged RTD connection.</p>	<p>Replace “To Process” RTD. <i>See Troubleshooting section entitled, Replacing the RTD.</i></p> <p>Check RTD connection, resecure as necessary.</p>
<p>“From Process” Temperature Element Failure</p> <div style="border: 1px solid black; padding: 5px; width: fit-content; margin: 5px auto;">tE2F</div> <div style="border: 1px solid black; padding: 5px; width: fit-content; margin: 5px auto;">HH.MM</div>	<p>Damaged “From Process” RTD.</p> <p>Loose or damaged RTD connection.</p>	<p>Replace the “From Process” RTD. <i>See Troubleshooting section entitled, Replacing the RTD.</i></p> <p>Check the RTD connection. Resecure as necessary.</p>

Shut Down Alarms (continued)

The chiller has automatically shut down because it has detected a serious problem that could damage your material or chiller.

Symptom	Possible cause	Solution
Process Temperature Switch High Shutdown <div style="border: 1px solid black; padding: 5px; margin: 5px 0; text-align: center;">tSHH</div> <div style="border: 1px solid black; padding: 5px; margin: 5px 0; text-align: center;">HH.MM</div>	<p>Hot-gas Bypass valve is not working properly. (possibly stuck open)</p> <p>Load is too high for the chiller.</p> <p>Process fluid is not flowing between the supply outlet and return inlet.</p> <p>The compressor is not running.</p> <p>Failed Process RTD.</p> <p>Load too high for chiller.</p> <p>Initial process temperature is too high.</p> <p>User-entered process fluid temperature is too high.</p> <p>Refrigerant charge is too low.</p> <p>User-entered Process High Passive Alarm Setpoint (H.AL) is set too low.</p> <p>Process High Temperature Alarm Delay and Inhibit times are set too short.</p>	<p>Have a certified refrigeration technician replace the solenoid valve.</p> <p>Reduce load to the chiller.</p> <p>Check for plugged pipes, closed valves, or failed flow switch.</p> <p>Check to see if compressor light is lit on the control. Check power to compressor and power to compressor contactor.</p> <p><i>See Troubleshooting section entitled, Replacing the RTD.</i></p> <p>Reduce the load on the chiller.</p> <p>Lower initial process fluid temperature.</p> <p>Lower user-entered process fluid temperature setpoint. <i>See Operation section entitled, Adjusting Setpoint Temperature.</i></p> <p><i>See Maintenance section entitled, Checking the Refrigerant Charge and Quality.</i></p> <p>Increase the Process High Passive Alarm Setpoint (H.AL). <i>See Operation section entitled, Adjusting the Process High Alarm Setpoint (H.AL).</i></p> <p>Increase the Process High Temperature Alarm Delay and Inhibit times. <i>See Operation sections entitled, Adjusting the Process High Inhibit Time (HA.i) and Adjusting the Process High Delay Time (HA.d).</i></p>

Shut Down Alarms (continued)

The chiller has automatically shut down because it has detected a serious problem that could damage your material or chiller.

Symptom	Possible cause	Solution
Process Temperature Deviation Low Shutdown	Load too low for chiller.	Increase the load on the chiller.
<div style="border: 1px solid black; padding: 5px; width: fit-content; margin: 0 auto;">tdLL</div>	Damaged or clogged Hot-gas Bypass valve.	Have a certified refrigeration technician replace the solenoid valve.
<div style="border: 1px solid black; padding: 5px; width: fit-content; margin: 0 auto;">HH.MM</div>	Compressor cut-out setpoint is set too low.	Adjust the compressor cut-out setpoint. <i>See Operation section entitled, Control Screen Descriptions, Screen 24.</i>
 NOTE: This setting will not be used unless critical for your particular application.	Process Deviation Low Setpoint is set too high.	Adjust the Process Deviation Low Alarm setpoint. <i>See Operation section entitled, Adjusting the Process Deviation Low Alarm setpoint (dE.L).</i>
	Process Low Alarm Inhibit Time set too low.	Adjust the Process Low Inhibit Time setpoint. <i>See Operation section entitled, Adjusting the Process Low Alarm Inhibit Time (L.Ai).</i>
	Process Low Alarm Delay Time set too low.	Adjust the Process Low Alarm Delay Time setpoint. <i>See Operation section entitled, Adjusting the Process Low Alarm Delay Time (L.Ad).</i>
	Load too low for chiller.	Increase the load on the chiller.
	Initial process temperature is too low.	Increase initial process fluid temperature.
	User-entered process fluid temperature too low.	Increase user-entered process temperature setpoint. <i>See Operation section entitled, Adjusting Setpoint Temperature.</i>
	Glycol usage not enabled.	Enable glycol usage, <i>see Operation section entitled, Glycol Operation Enable/Disable.</i>
	Water flow is too low.	Adjust water flow to your specific chiller model. <i>See Description section entitled, Specifications: EarthSmart ECW and ECW Series.</i>
	Faulty compressor contactor.	Verify that the compressor contactor disengages in Stop mode, replace as necessary.
	Improperly adjusted Process Deviation Low Shutdown Alarm setpoint.	Re-adjust setpoint. <i>See Operation section entitled, Adjusting the Process Deviation Low Shutdown Alarm Setpoint (dL.L).</i>

Shut Down Alarms (continued)

The chiller has automatically shut down because it has detected a serious problem that could damage your material or chiller.

Symptom	Possible cause	Solution
<p>Compressor Cycles Per Hour Exceeded Shutdown</p> <div style="border: 1px solid black; padding: 5px; width: fit-content; margin: 5px auto;">CCPH</div> <div style="border: 1px solid black; padding: 5px; width: fit-content; margin: 5px auto;">HH.MM</div>	<p>The compressor Cut-in and Cut-out set-points are too low.</p> <p>The Hot-gas Bypass valve is not functioning properly.</p> <p>The chiller has not been properly tuned.</p>	<p>Increase the Cut-in and Cut-out set-points. <i>See Operation section entitled, Control Function Descriptions, Screens 24 and 25.</i></p> <p>Check to ensure the chiller is sized correctly to your application. <i>See Description section entitled, Specifications: EarthSmart ECW and ECW Series.</i></p> <p><i>See Maintenance section entitled, Checking the Hot-gas Bypass Valve.</i></p> <p>Reload factory Autotune presets. <i>See Operation section entitled, Control Function Descriptions, Screens 13, 14, 15 and 16.</i></p>
<p>Process Temperature Switch Low Shutdown (Freeze Protection)</p> <div style="border: 1px solid black; padding: 5px; width: fit-content; margin: 5px auto;">tSLL</div> <div style="border: 1px solid black; padding: 5px; width: fit-content; margin: 5px auto;">HH.MM</div>	<p>Load too low for chiller.</p> <p>Damaged or clogged Hot-gas Bypass valve.</p> <p>Glycol usage not enabled.</p> <p>Faulty flow switch.</p> <p>Process setpoint is set too low.</p> <p>The compressor “Cut-out” setpoint is improperly adjusted.</p>	<p>Increase the load on the chiller.</p> <p>Have a certified refrigeration technician replace the solenoid valve.</p> <p>Enable glycol usage, <i>see Operation section entitled, Glycol Operation Enable/Disable.</i></p> <p>Check flow switch operation, <i>see Maintenance section entitled, Checking or Cleaning the Flow Switch.</i></p> <p>Re-adjust the process setpoint higher or add glycol to the process coolant and re-adjust the Process Temperature Switch Low Shutdown setpoint to allow lower temperature. <i>See Installation section entitled, Filling the Chiller and Operation section entitled, Adjusting the Process Temperature Switch Low Shutdown Setpoint.</i></p> <p>Contact Conair Service.</p>

Additional Alarms

Symptom	Possible cause	Solution
<p>Software EEPROM Reset</p> <div style="border: 1px solid black; padding: 2px; width: fit-content; margin-bottom: 5px;">err</div> <div style="border: 1px solid black; padding: 2px; width: fit-content;">0297</div>	<p>Reloading the chiller's default parameters.</p>	<p>Restart the chiller to clear the alarm.</p>
<p>Diagnostic ROM Error</p> <div style="border: 1px solid black; padding: 2px; width: fit-content; margin-bottom: 5px;">err</div> <div style="border: 1px solid black; padding: 2px; width: fit-content;">1400</div>	<p>Diagnostic of the "Read-only Memory" during start-up has failed.</p>	<p>Restart the chiller. Replace the chiller's control board.</p>
<p>Diagnostic RAM Error</p> <div style="border: 1px solid black; padding: 2px; width: fit-content; margin-bottom: 5px;">err</div> <div style="border: 1px solid black; padding: 2px; width: fit-content;">1401</div>	<p>Diagnostic of the "Random Access Memory" during start-up has failed.</p>	<p>Restart the chiller. Replace the chiller's control board.</p>
<p>EEPROM Defaults Loaded</p> <div style="border: 1px solid black; padding: 2px; width: fit-content; margin-bottom: 5px;">err</div> <div style="border: 1px solid black; padding: 2px; width: fit-content;">1402</div>	<p>The system was programmed from a blank start or the system was erased and then re-programmed.</p>	<p>Restart the chiller.</p>

Additional Alarms (continued)

Symptom	Possible cause	Solution
EEPROM Write Error <div style="border: 1px solid black; padding: 2px; width: fit-content; margin: 5px 0;">err</div> <div style="border: 1px solid black; padding: 2px; width: fit-content; margin: 5px 0;">1403</div>	The EEPROM writing function fails testing to ensure a saved value or parameter was written correctly.	Restart the chiller. Replace the chiller's control board.
Corrupt Alarm History Log <div style="border: 1px solid black; padding: 2px; width: fit-content; margin: 5px 0;">err</div> <div style="border: 1px solid black; padding: 2px; width: fit-content; margin: 5px 0;">1495</div>	The control fails to verify the contents of the Alarm History Log, during start-up. The number of power cycles of the chiller reaches 9,999.	Restart the chiller. Restart the chiller.
Too Many EEPROM Writes <div style="border: 1px solid black; padding: 2px; width: fit-content; margin: 5px 0;">err</div> <div style="border: 1px solid black; padding: 2px; width: fit-content; margin: 5px 0;">1496</div>	The rate at which values and parameters are being stored to the chiller's long-term memory in EEPROM exceeds ten writes per second.	Contact Conair Service.

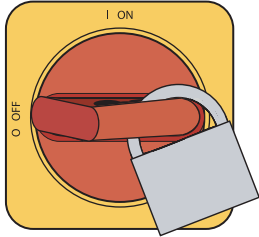

IMPORTANT: Always refer to the wiring diagrams that came with your chiller to locate specific electrical components. Illustrations in the User Guide are intended to be representative only.



NOTE: These connections may vary depending on the model you have purchased. Be sure to see the labeling on your particular unit.

Replacement RTDs are available from Conair.

Contact Conair Parts
(800) 458 1960
From outside of the
United States, call:
(814) 437 6861

Replacing the RTD

To replace the RTD:

- 1 Disconnect and lockout power to the chiller.**
- 2 Disconnect the “To Process” tubing from the “To Process” connection.**

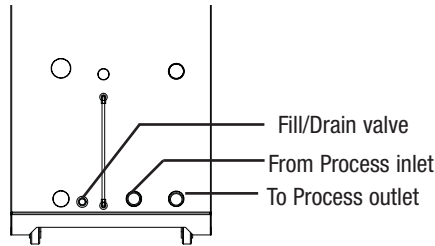

- 3 Open the Drain/Fill valve and drain water from the unit** so the water level is lower than the RTD.

- 4 Open the left-side of the chiller. (As viewed from the control)**

- 5 Disconnect the RTD wiring from the back of the electrical enclosure.** Refer to the wiring diagram.

- 6 Remove the RTD.** Loosen the compression nut to slide the RTD out of the evaporator.

- 7 Install the new RTD.** The new RTD should be inserted in the evaporator so that the tip is extended completely through the evaporator.

- 8 Wire the RTD to the inlet port on the back of the electrical enclosure.**

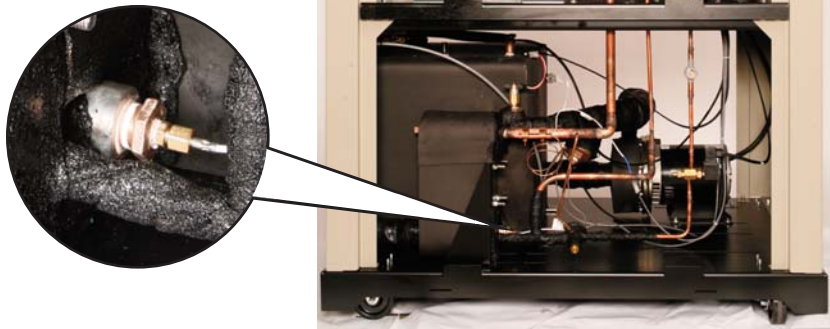

Removing Pump Components

The pump's wet end (impeller, motor, and seal assembly) can be removed for service.

- 1 Disconnect and lockout power to chiller.**
- 2 Open the drain/fill valve and drain the water from the chiller.**

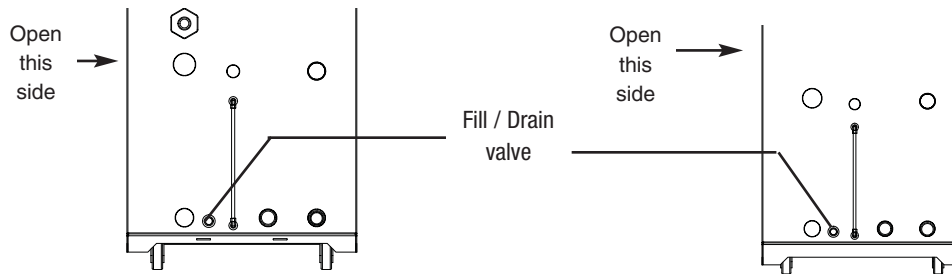
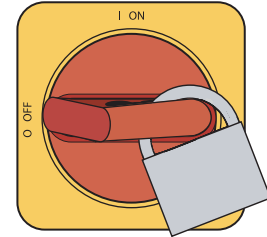

- 3 Open the right-side of the chiller. (As viewed from the control)**
- 4 Remove the bolts connecting the pump motor to the pump base.**
- 5 Remove the pump volute bolts.**
- 6 Inspect, clean, and replace pump parts as needed.** Separate the pump assembly from the pump volute (casing) by prying the flanges and pulling apart. Follow the disassembly and reassembly procedures in the pump manufacturer's manual that accompanies this User Guide.

 **NOTE:** These connections may vary depending on the model you have purchased. Be sure to see the labeling on your particular unit.



IMPORTANT: Always refer to the wiring diagrams that came with your chiller to locate specific electrical components. Illustrations in the User Guide are intended to be representative only.

Replacement pump components are available from Conair.

Contact Conair Parts
(800) 458 1960
From outside of the
United States, call:
(814) 437 6861

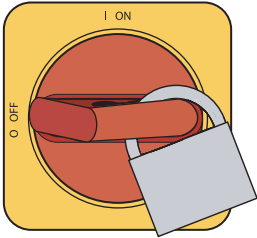

IMPORTANT: Always refer to the wiring diagrams that came with your chiller to locate specific electrical components. Illustrations in the User Guide are intended to be representative only.

Replacement pump components are available from Conair.

Contact Conair Parts
(800) 458 1960
From outside of the
United States, call:
(814) 437 6861

Replacing the Contactor



WARNING: Electrical hazard

Before performing any work on this unit, disconnect and lock out electrical power sources to prevent injury from unexpected energization or startup.

To replace contactor for the pump, compressor or fan:

- 1 Disconnect and lockout power to the chiller.**
- 2 Open the electrical enclosure and locate the correct contactor.** Refer to the wiring diagrams you received with your chiller.
- 3 Disconnect the wiring from the contactor.** Make sure you label each wire so you can correctly install the new contactor.
- 4 Remove the contactor by snapping it off the DIN rail mounting.** Press the top of contactor downward and tip the bottom towards you.
- 5 Snap in the new contactor on the DIN rail.**
- 6 Reconnect the wiring, close the electrical enclosure and reapply main power to the chiller.**
- 7 Test installation by running the chiller under normal load.**

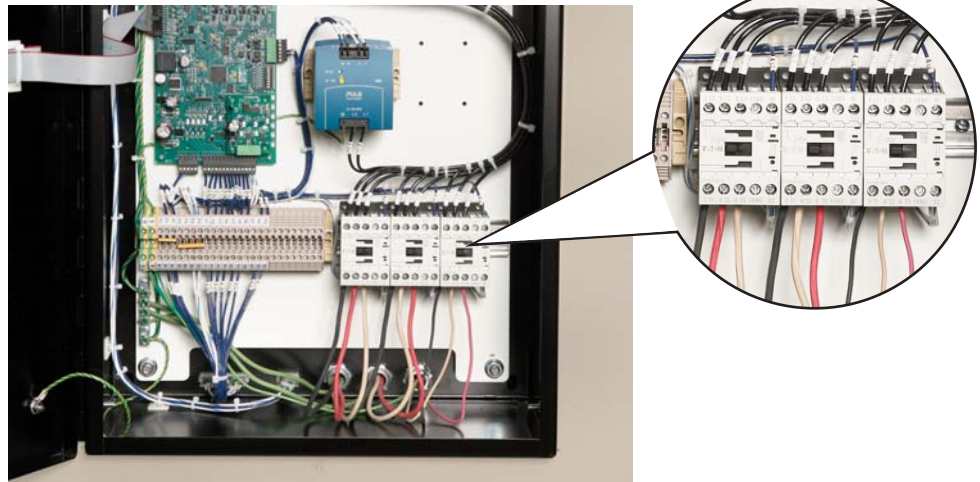

We're Here to Help

Conair has made the largest investment in customer support in the plastics industry. Our service experts are available to help with any problem you might have installing and operating your equipment. Your Conair sales representative also can help analyze the nature of your problem, assuring that it did not result from misapplication or improper use.

Additional manuals and prints for your Conair equipment may be ordered through the Customer Service or Parts Department for a nominal fee. Most manuals can be downloaded free of charge from the product section of the Conair website.
www.conairgroup.com

How to Contact Customer Service

To contact Customer Service personnel, call:



 **NOTE:** Normal operating hours are 8:00 am - 5:00 pm EST. After hours emergency service is available at the same phone number.

Before You Call...

If you do have a problem, please complete the following checklist before calling Conair:

- Make sure you have all model, control type and serial numbers from the serial tag, and parts list numbers for your particular equipment. Service personnel will need this information to assist you..
- Make sure power is supplied to the equipment.
- Make sure that all connectors and wires within and between control systems and related components have been installed correctly.
- Check the troubleshooting guide of this manual for a solution.
- Thoroughly examine the instruction manual(s) for associated equipment, especially controls. Each manual may have its own troubleshooting guide to help you.
- Check that the equipment has been operated as described in this manual.
- Check accompanying schematic drawings for information on special considerations.

Equipment Guarantee

Conair guarantees the machinery and equipment on this order, for a period as defined in the quotation from date of shipment, against defects in material and workmanship under the normal use and service for which it was recommended (except for parts that are typically replaced after normal usage, such as filters, liner plates, etc.). Conair's guarantee is limited to replacing, at our option, the part or parts determined by us to be defective after examination. The customer assumes the cost of transportation of the part or parts to and from the factory.

Performance Warranty

Conair warrants that this equipment will perform at or above the ratings stated in specific quotations covering the equipment or as detailed in engineering specifications, provided the equipment is applied, installed, operated and maintained in the recommended manner as outlined in our quotation or specifications.

Should performance not meet warranted levels, Conair at its discretion will exercise one of the following options:

- Inspect the equipment and perform alterations or adjustments to satisfy performance claims. (Charges for such inspections and corrections will be waived unless failure to meet warranty is due to misapplication, improper installation, poor maintenance practices or improper operation.)
- Replace the original equipment with other Conair equipment that will meet original performance claims at no extra cost to the customer.
- Refund the invoiced cost to the customer. Credit is subject to prior notice by the customer at which time a Return Goods Authorization Number (RGA) will be issued by Conair's Service Department. Returned equipment must be well crated and in proper operating condition, including all parts. Returns must be prepaid.

Purchaser must notify Conair in writing of any claim and provide a customer receipt and other evidence that a claim is being made.

Warranty Limitations

Except for the Equipment Guarantee and Performance Warranty stated above, Conair disclaims all other warranties with respect to the equipment, express or implied, arising by operation of law, course of dealing, usage of trade or otherwise, including but not limited to the implied warranties of merchantability and fitness for a particular purpose.

Maintenance Log

Date	Reading							
Maintenance Item								
Compressor Amps, 100% loaded								
Discharge Pressure								
Suction pressure								
Evaporator water out/inlet temperature								
Process Water Pressure								
Condenser Water Temperature, In/Out								
Condenser Water Pressure, In/Out								
Condenser Fan Amps								
Process Pump Amps								
Unit Volts								
Condenser Air Temp In								
Condenser Air Temp Out								
Oil Level								
Temperature Setpoint								
RTD Temperatures (4)								
To Process Temperature								
From Process Temperature								

Pressure Tables

Evaporator and Piping Pressure Drops

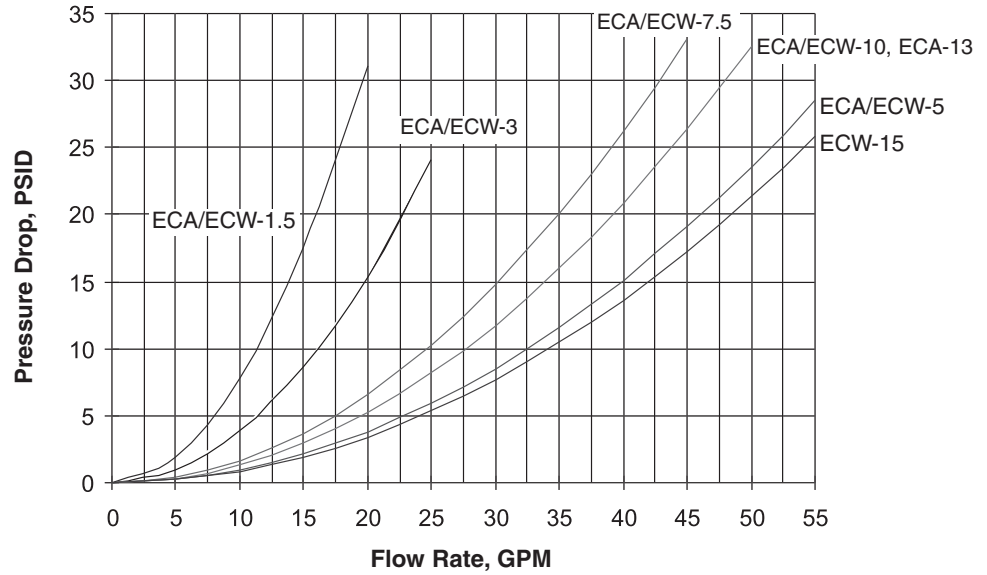

Condenser and Piping Pressure Drops

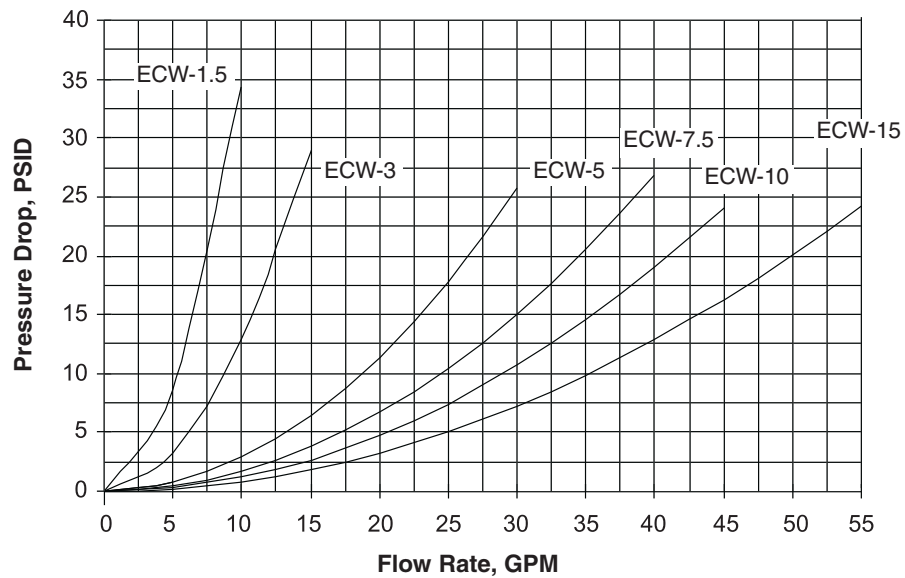

Water Quality Control

Insufficient or improper water treatment can damage the EarthSmart Chiller. A certified water treatment specialist should be consulted for your particular application. It is the owner's responsibility to prevent damage from foreign material or inadequate water treatment.

The two main points to consider for water treatment in chillers are:

- **Corrosion**
- **Organism growth**

Proper chemical treatment will control pH levels and algae growth.

Overhead Plumbing Details

Overhead piping installations above process connections require installing a check valve in the “To Process” line and a 12 inch {305 mm} riser with check valve and vacuum break in the “From Process” line to prevent siphoning when shutting down the chiller. Install a vent tube 12 inches {305 mm} above the highest system point to prevent over pressurization. Maximum height of piping above process connections is 25 ft {7.6 m}.

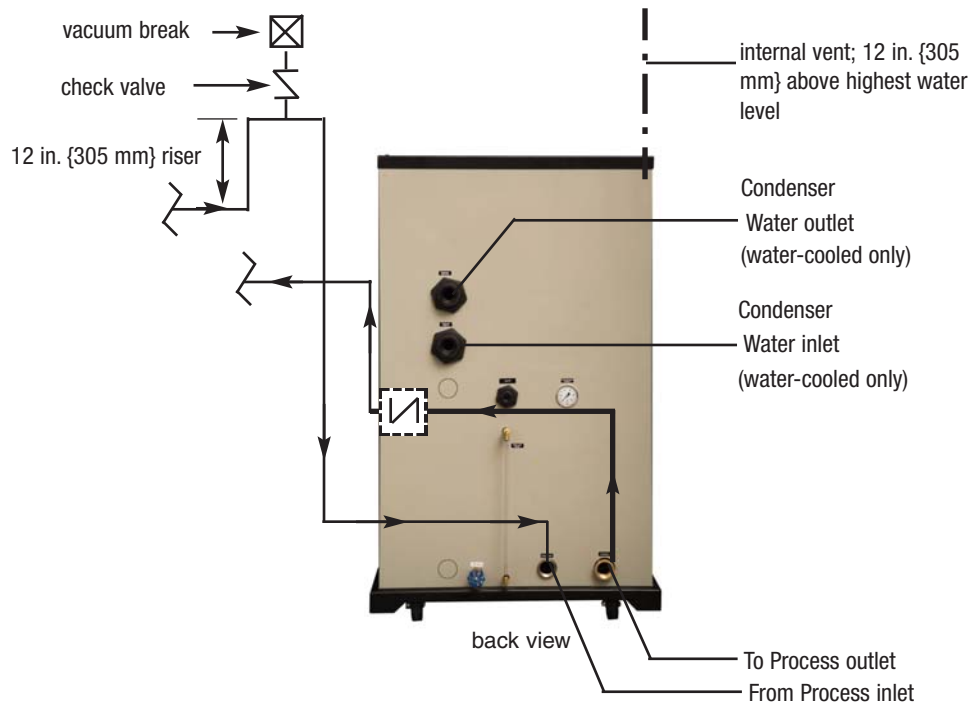

RTD Resistance Chart

You can use the following chart to determine if you need to replace your RTD.

Temp °F	+ 0	+ 1	+ 2	+ 3	+ 4	+ 5	+ 6	+ 7	+ 8	+ 9
0	93.0334	93.2517	93.4699	93.6881	93.9063	94.1244	94.3425	94.5605	94.7786	94.9965
10	95.2145	95.4324	95.6503	95.8681	96.0859	96.3036	96.5214	96.7390	96.9567	97.1743
20	97.3919	97.6094	97.8269	98.0444	98.2618	98.4792	98.6966	98.9139	99.1312	99.3485
30	99.5657	99.7829	100.000	100.217	100.434	100.651	100.868	101.085	101.302	101.519
40	101.736	101.953	102.169	102.386	102.603	102.820	103.036	103.253	103.469	103.686
50	103.903	104.119	104.335	104.552	104.768	104.985	105.201	105.417	105.633	105.849
60	106.066	106.282	106.498	106.714	106.930	107.146	107.362	107.578	107.794	108.009
70	108.225	108.441	108.657	108.872	109.088	109.304	109.519	109.735	109.950	110.166
80	110.381	110.596	110.812	111.027	111.242	111.458	111.673	111.888	112.103	112.318
90	112.533	112.748	112.963	113.178	113.393	113.608	113.823	114.038	114.253	114.468

Temp °F	+ 0	+ 1	+ 2	+ 3	+ 4	+ 5	+ 6	+ 7	+ 8	+ 9
100	114.682	114.897	115.112	115.326	115.541	115.755	115.970	116.184	116.399	116.613
110	116.828	117.042	117.256	117.470	117.685	117.899	118.113	118.327	118.541	118.755
120	118.969	119.183	119.397	119.611	119.825	120.039	120.253	120.466	120.680	120.894
130	121.107	121.321	121.535	121.748	121.962	122.175	122.389	122.602	122.815	123.029
140	123.242	123.455	123.668	123.882	124.095	124.308	124.521	124.734	124.947	125.160
150	125.373	125.586	125.799	126.011	126.224	126.437	126.650	126.862	127.075	127.288
160	127.500	127.713	127.925	128.138	128.350	128.563	128.775	128.987	129.200	129.412
170	129.624	129.836	130.049	130.261	130.473	130.685	130.897	131.109	131.321	131.533
180	131.744	131.956	132.168	132.380	132.592	132.803	133.015	133.227	133.438	133.650
190	133.861	134.073	134.284	134.496	134.707	134.918	135.130	135.341	135.552	135.763



IMPORTANT: Always refer to the wiring diagrams that came with your chiller to locate specific electrical components. Illustrations in the User Guide are intended to be representative only.

Optional Autofill hardware is available from Conair.

Contact Conair Parts
(800) 458 1960
From outside of the
United States, call:
(814) 437 6861

Installing Autofill (optional)



WARNING: Improper installation, operation or servicing may result in equipment damage or personal injury.

This equipment should only be installed, adjusted and serviced by a qualified technician who is familiar with the construction, operation and potential hazards of this type of machine.

All wiring, disconnects and fuses should be installed by a qualified electrical technician in accordance with electrical codes in your region. Always maintain a safe ground. Do not operate the equipment at power levels other than what is specified on the machine data plate.



WARNING: Electrical hazard

Before performing any work on this equipment, disconnect and lock out electrical power sources to prevent injury from unexpected energization or startup.

The optional Autofill function is used to maintain the proper water level in the EarthSmart Chiller's reservoir. A float level switch is used to sense the water level. When the switch contacts close, an input signal is sent to the control board to open the water makeup solenoid valve which allows water to enter the chiller's reservoir.

When the water level opens the switch, the control will wait until the Autofill Delay Time (AF.d) has expired before shutting off the valve. If the float switch remains open for more than the set duration of the Autofill Timer (AF.t), the control will display a Level Switch High Alarm (LSH) and immediately shut off the valve.

If the chiller's reservoir has not been filled before the Autofill Timer has expired, re-adjust the Autofill Timer or press the "**Alarm Acknowledgement**" button to restart the timer.

To install the Autofill function:

- 1 Disconnect and lockout power to the chiller.**
- 2 Shut of the "To Process" and "From Process" valves (factory optional).**

Installing Autofill (optional) (continued)

- 3** Remove the chiller's left and right-side panels.
- 4** Locate the 1/2 inch reservoir plugs on the top left corner and right side of the reservoir. The chiller's reservoir is located in the bottom portion of the chiller's cabinet and towards the back.
- 5** Remove the Autofill knockout, on the back of the chiller above the water level gauge.
- 6** Connect the brass piping to the "In" side of the solenoid valve, by using Teflon tape or pipe dope. Do not over-tighten.

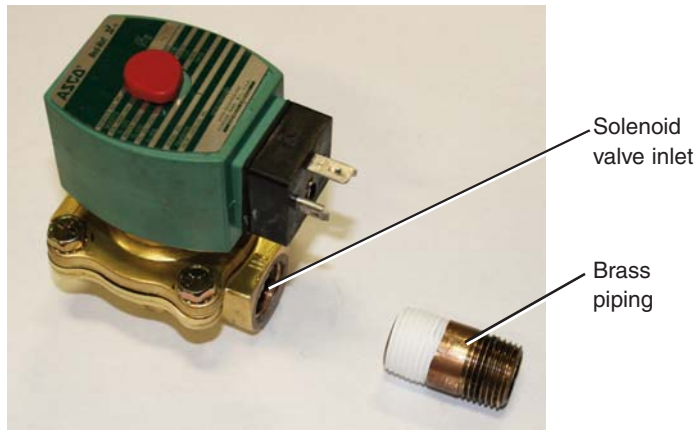

- 7** Connect one (1) of the hose barbs to the "Out" side of the solenoid, by using Teflon tape or pipe dope. Do not over-tighten.

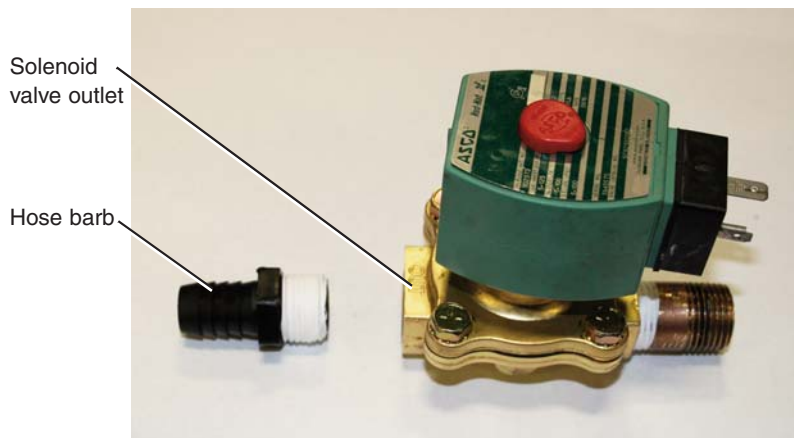

(continued)

Installing Autofill (optional) (continued)

- 8** Connect the brass piping to the outlet of the bulkhead, by using Teflon tape or pipe dope. Do not over-tighten. Install the gasket on the thread side of the bulkhead.

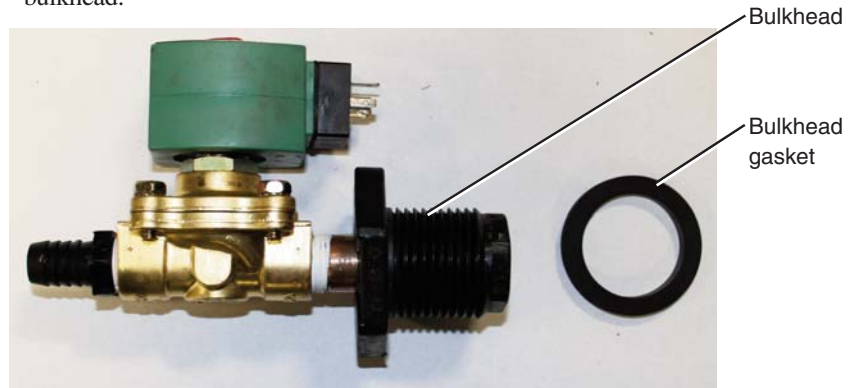

- 9** Connect the hosing to the hose barb, secure with a hose clamp.

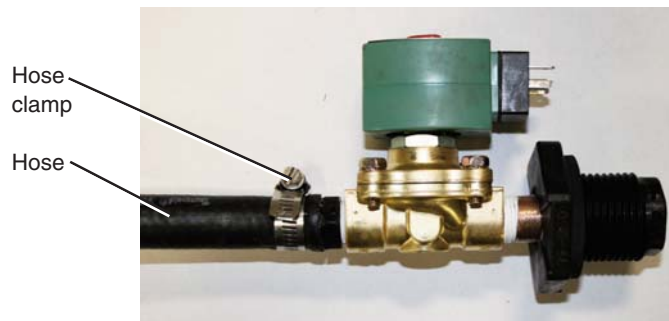

- 10** Insert the solenoid assembly through the knock-out on the back of the chiller, secure it with the left-handed retaining nut. Do not over-tighten.

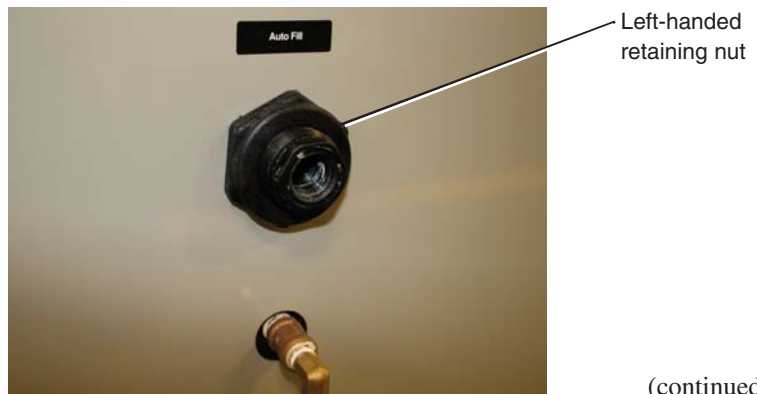

Installing Autofill (optional) (continued)

- 11** Connect one (1) hose barb to the 90° street pipe, by using Teflon tape or pipe dope. Do not over-tighten.

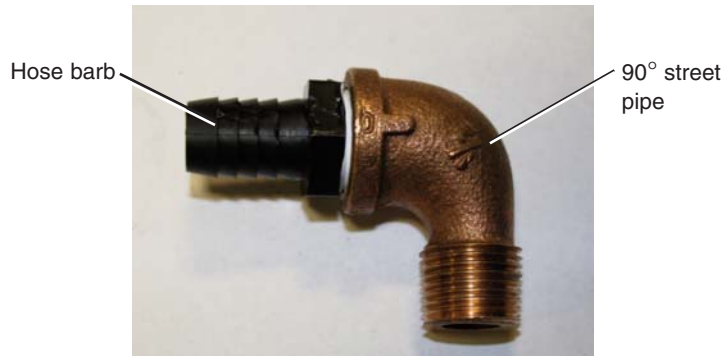

- 12** Connect the 90° street pipe assembly to the chiller's reservoir, by using Teflon tape or pipe dope. Do not over-tighten.

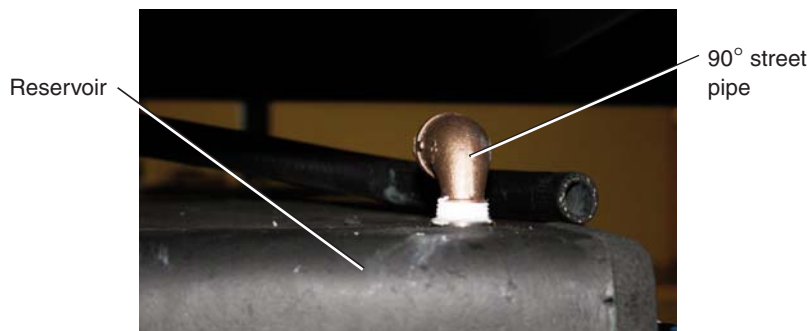

- 13** Connect the loose end of pipe from the solenoid assembly to the 90° street pipe assembly, by securing the connection with a clamp. Do not over-tighten.

(continued)

Installing Autofill (optional) (continued)

- 14** Connect the solenoid plug to the Autofill (13PL) receptical. The Autofill plug is coiled near the lower back of the electrical enclosure in the upper portion of the chiller's cabinet.

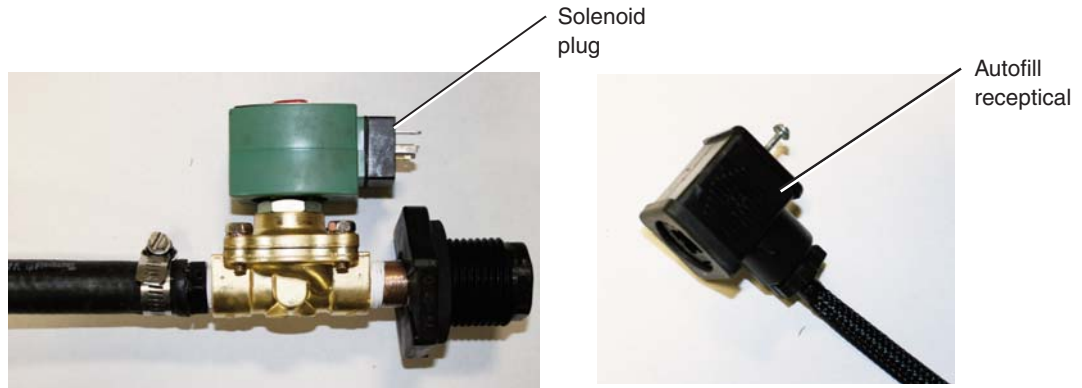

IMPORTANT: Always refer to the wiring diagrams that came with your chiller to locate specific electrical components. Illustrations in the User Guide are intended to be representative only.

- 15** Locate the second port orientated on the reservoir's upper portion facing towards the front of the chiller.

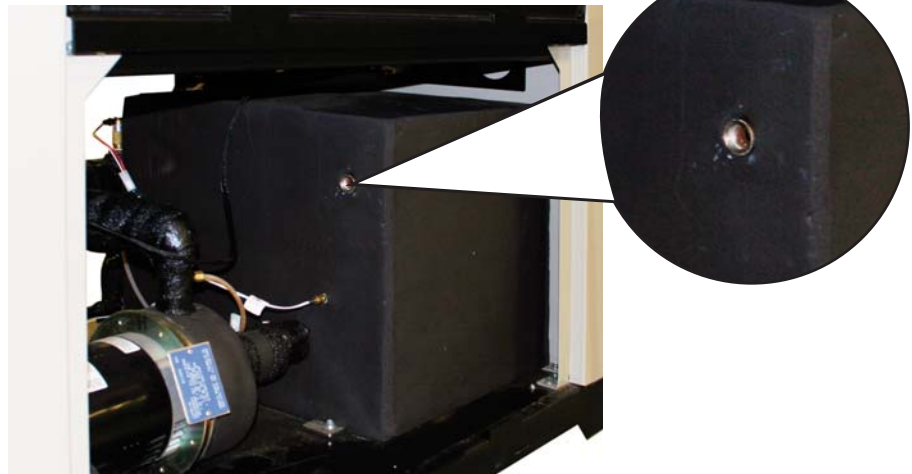

(continued)

Installing Autofill (optional) (continued)

- 16** Install the Autofill switch into the port located on the reservoir's upper portion facing towards the front of the chiller, using Teflon tape or pipe dope. Do not over-tighten. Ensure that the switch is oriented vertically to allow free movement of the switch.

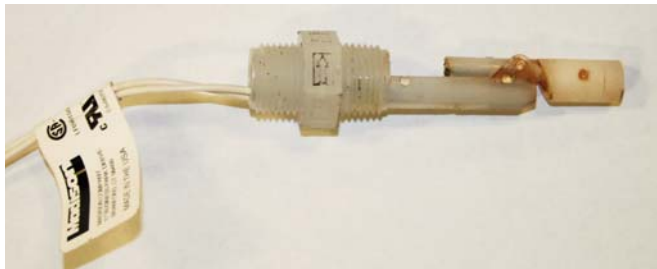

 **NOTE:** Mark the location the the arrow on the Autofill switch. This arrow **must** point upward for the switch to operate properly.

- 17** Connect the Autofill switch to the Autofill (12PL) receptical. The Autofill switch plug is coiled near the lower back of the electrical enclosure in the upper portion of the chiller's cabinet.

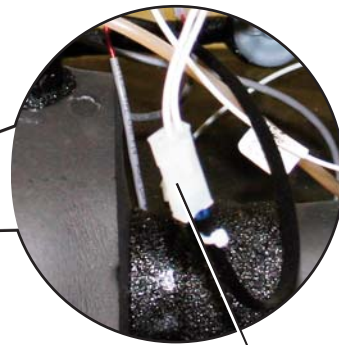
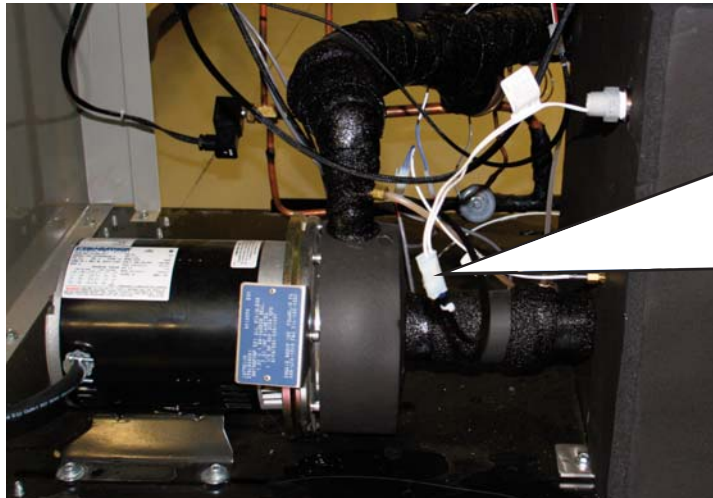

Autofill switch receptical

(continued)

Installing Autofill (optional) (continued)



IMPORTANT: Always refer to the wiring diagrams that came with your chiller to locate specific electrical components. Illustrations in the User Guide are intended to be representative only.

- 18** Open the electrical enclosure and install the Autofill option board into I/O CARD1 HEADER located at the bottom right of the control main board.

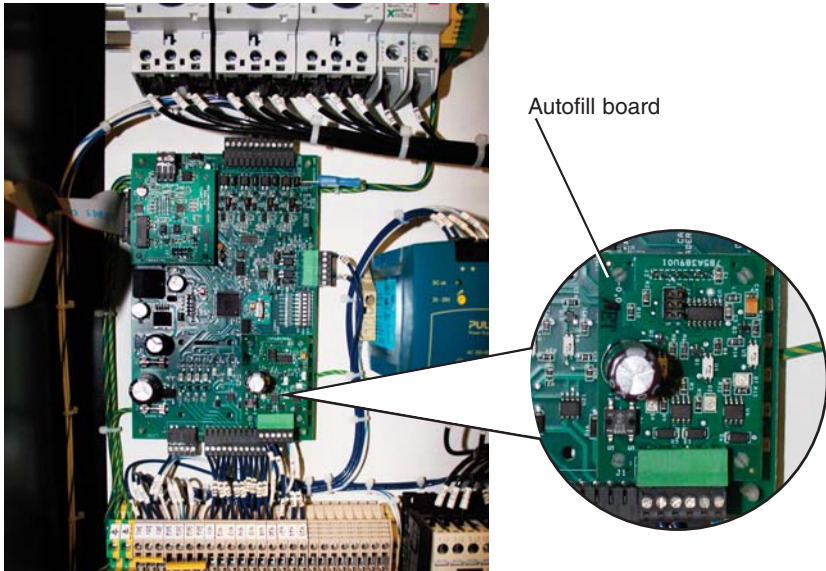

- 19** Wire the Autofill board as shown to wire terminations 301, 302 and 421.

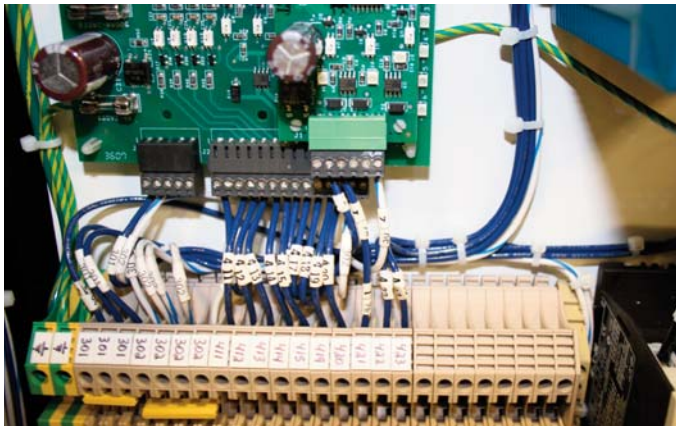

- 20** Close the electrical enclosure, once wiring of the Autofill option is complete.

Installing Autofill (optional) (continued)

- 21** Test the Autofill installation, by closing the drain valve and opening the Autofill supply water.

- 22** Check for leaks by the solenoid valve or on any other fittings and repair as needed.

- 23** Turn on main power supply to the chiller and listen for the solenoid valve to open and monitor the level gauge until the gauge is full.

Cleaning the Autofill Valve (optional)



WARNING: Electrical hazard

Before performing any work on this unit, disconnect and lock out electrical power sources to prevent injury from unexpected energization or startup.

If the EarthSmart Chiller has the optional Autofill valve, it may periodically need servicing to keep the free flow of incoming water into the chiller's reservoir.

The clean/replace the optional Autofill valve:

- 1 Disconnect and lockout power to the chiller.**
- 2 Shut of the “To Process” and “From Process” (factory optional) and Autofill water sources valves.**

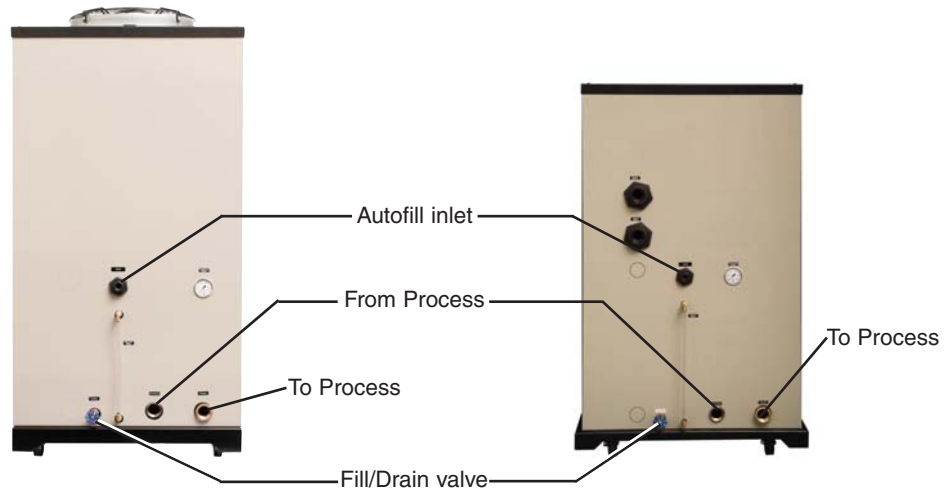

- 3 Open the Fill/Drain valve on the back of the chiller, to drain out the process fluid.**
- 4 Disconnect the Autofill water feed from the optional Autofill inlet.**

(continued)

Cleaning the Autofill Valve (optional)

(continued)

5 Remove the chiller's left and right-side panels.

6 Locate the optional Autofill solenoid above the chiller's reservoir.

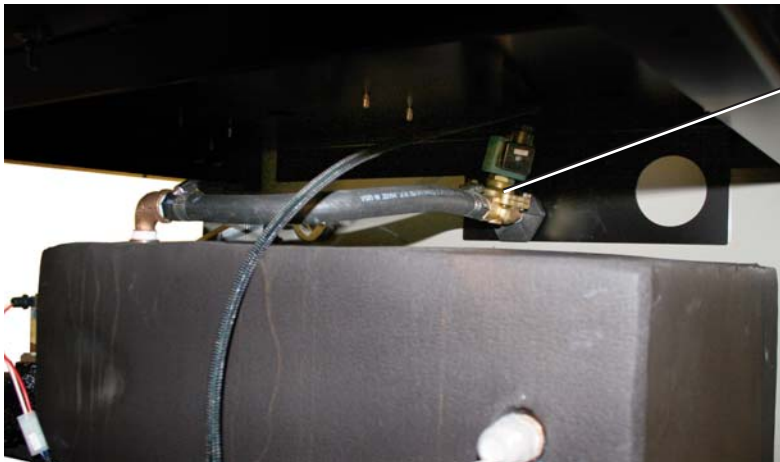

7 Disconnect the solenoid plug from the Autofill (13PL) receptical.

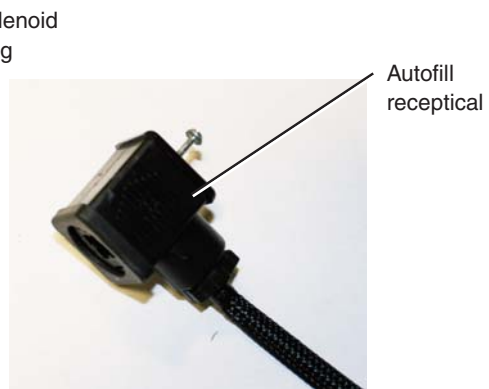

(continued)

Cleaning the Autofill Valve (optional)

(continued)

- 8 Unscrew the Autofill bulkhead left-handed retaining nut located on the back of the chiller. Remove the bulkhead assembly from the chiller panel.



- 9 Unscrew the bulkhead assembly from the brass fitting on the Autofill solenoid.

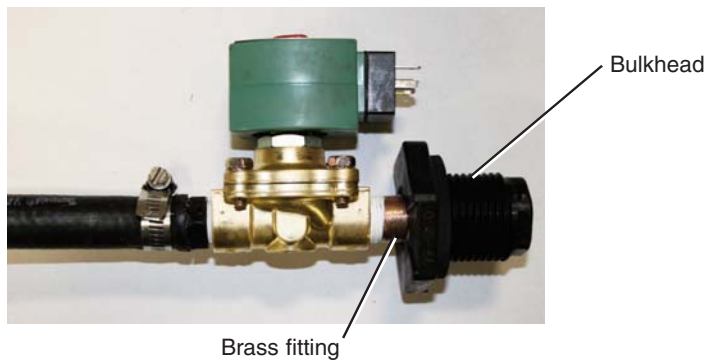

(continued)

Cleaning the Autofill Valve (optional)

(continued)

- 10** Loosen the pipe clamp on the hosing routed to the chiller's reservoir, Remove hosing from the Autofill solenoid and then remove the entire Autofill solenoid from the chiller.



- 11** Remove the four (4) bolts that hold together the top and bottom portions of the solenoid valve and open the valve.

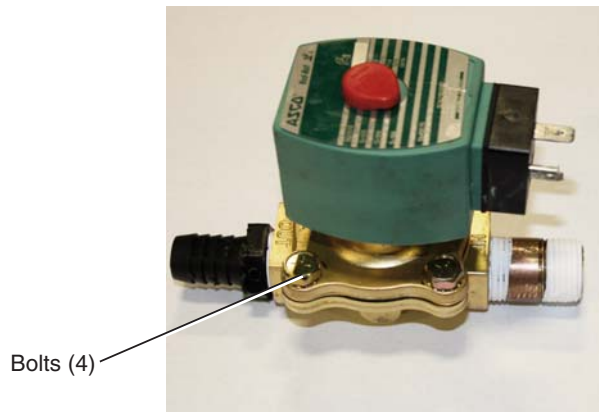

(continued)

Cleaning the Autofill Valve (optional)

(continued)

- 12** Inspect the top and bottom portions of the solenoid for deposit build-up, wear or tearing, clean or replace as necessary.

 **NOTE:** In the image to the right, the hose barb and brass fitting have been removed. This is not necessary for maintenance purposes.

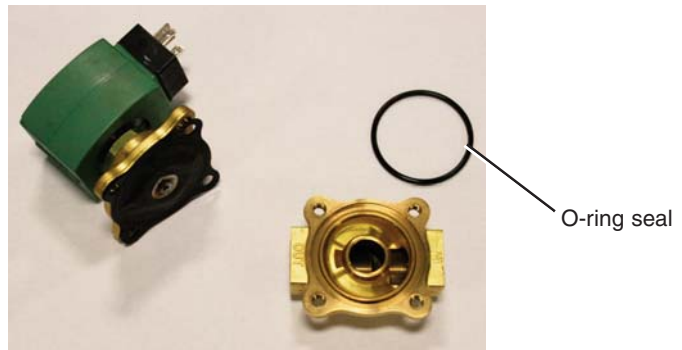

Replacement solenoid valves or solenoid valve repair kits are available from Conair.

Contact Conair Parts
(800) 458 1960
From outside of the
United States, call:
(814) 437 6861

- 13** Check the resistance across each terminal of the solenoid valve with an ohm meter. If there is infinite resistance between the terminals, the solenoid valve will not energize and must be repaired or replaced.

(continued)

Cleaning the Autofill Valve (optional)

(continued)

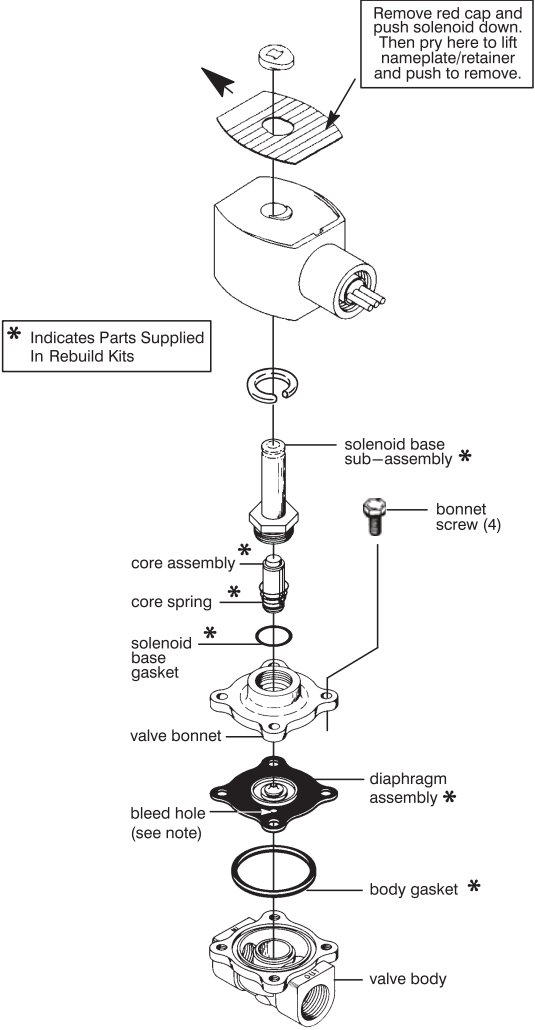

14 Follow steps 1-11 in reverse order to re-install the Autofill solenoid. Ensure to replace and properly seat the o-ring seal between the top and bottom portions of the solenoid valve assembly.

Compressor Module Troubleshooting*

I

o

o

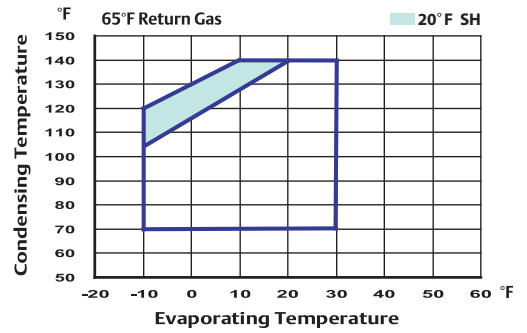
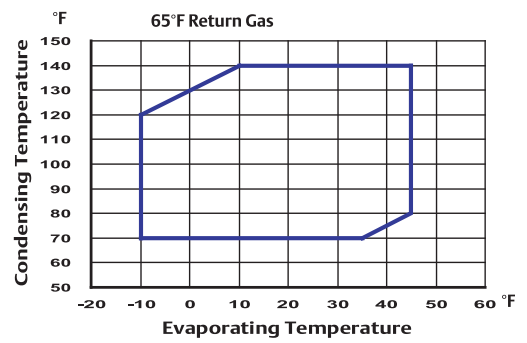

*This document is provided courtesy of Emerson Climate Technologies. This document may be updated regularly. Go to www.EmersonClimate.com to check for the most recent materials.

Compressor Module Troubleshooting (continued)

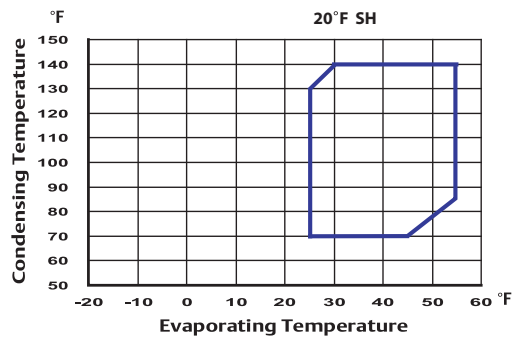
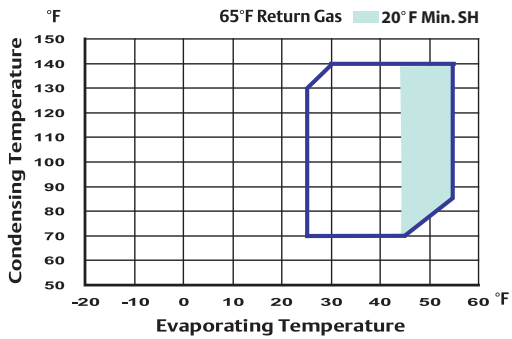
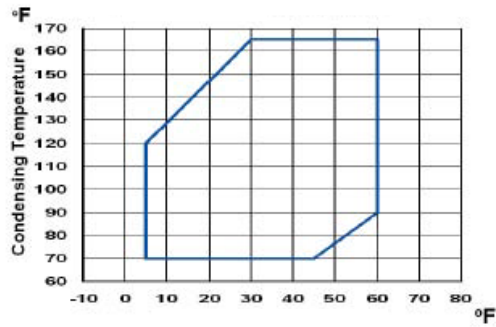
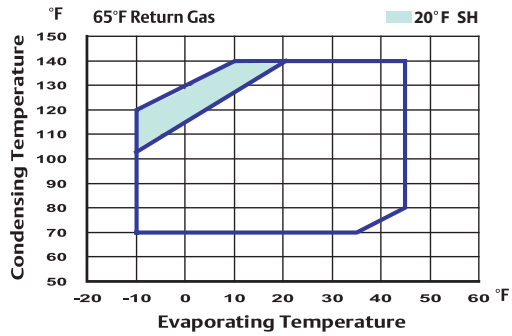

I I	

Compressor Module Troubleshooting (continued)



Compressor Module Troubleshooting (continued)

I

I	

Compressor Module Troubleshooting (continued)

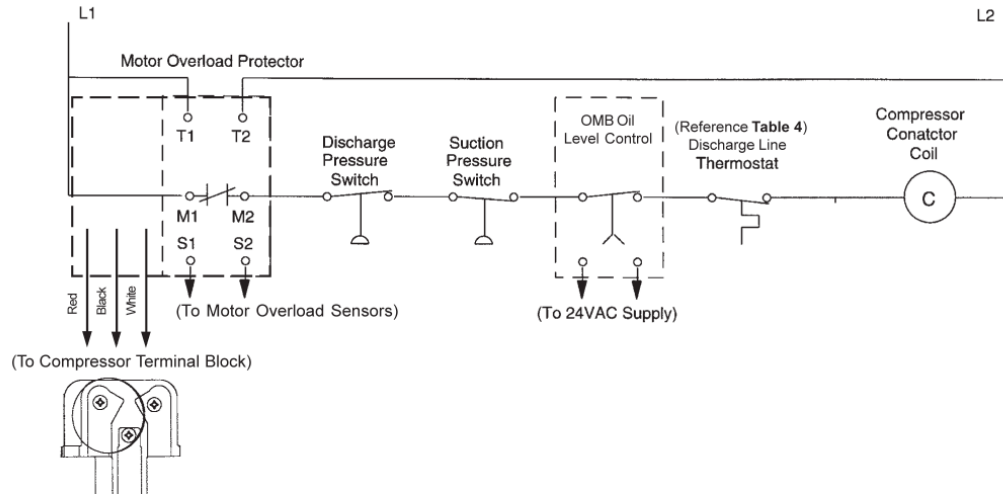

Compressor Module Troubleshooting (continued)

of 9 VDC for checking – do not attempt to check continuity through the sensors with any other type of instrument. Any external voltage or current may cause damage requiring compressor replacement.

- a. During normal operation, this resistance value should read less than 4500 ohms $\pm 20\%$.
 - b. If the M1-M2 contacts are open, the measured S1-S2 value is above 2750 ohms $\pm 20\%$ and the compressor has been tripped less than 30 minutes then the module is functioning properly.
- If the S1-S2 wire leads read less than 2750 ohms $\pm 20\%$ and the M1-M2 contacts are open, reset the module by removing the power to T1-T2 for a minimum of 5 seconds.
 - Replace all wire leads and use a voltmeter to verify the M1-M2 contacts are closed.
 - If the M1-M2 contacts remain open and S1-S2 are less than 2500 ohms, remove leads from the M1-M2 contacts and jumper together;

CAUTION: Compressor should start at this time. HOWEVER DO NOT LEAVE JUMPER IN PLACE FOR NORMAL SYSTEM OPERATIONS. THE JUMPER IS USED FOR DIAGNOSTIC PURPOSES ONLY.

- Go to Compressor Supply Voltage Troubleshooting.

Compressor Voltage Supply Troubleshooting

- Remove phase sensing leads from the module from L1/L2/L3.
- Use a voltmeter to measure the incoming 3 phase voltage on L1/L2/L3. WARNING: L1/L2/L3 could

be at a potential up to 600VAC.

- Ensure proper voltage on each phase.
- Remove power to the module for a minimum of 5 seconds to reset and replace all wire leads. Re-energize the module. If the M1-M2 contacts are open with proper voltage to T1-T2, L1/L2/L3 and proper resistance to S1-S2 then the module is faulty and should be replaced.

Compressor Module Troubleshooting (continued)

Compressor Mounting

Compressor mounting must be selected based on application. Consideration must be given to sound reduction tubing reliability. Some tubing geometry or “shock loops” may be required to reduce vibration transferred from the compressor to external tubing.

Mounting for Rack Systems

Specially designed steel spacers and rubber isolator pads are available for our refrigeration scroll 7.5-15 HP scroll rack applications. This mounting arrangement limits the compressors motion thereby minimizing potential problems of excessive tubing stress. Sufficient isolation is provided to prevent vibration from being transmitted to the mounting structure. This mounting arrangement is recommended for multiple compressor rack installations. See **Figure 4** for a detail for this mounting system.

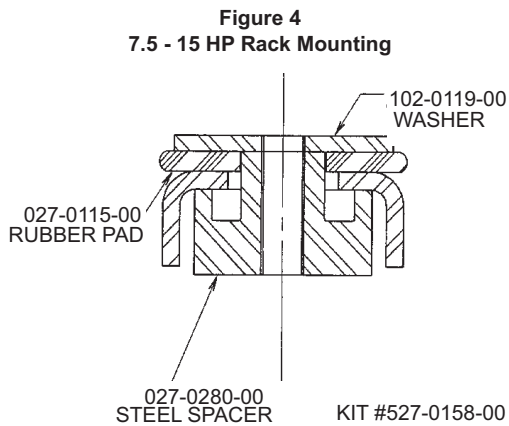

Note: The use of standard soft grommets is not recommended for our refrigeration scroll rack installations. These “softer” mounts allow for excessive movement that will result in tube breakage unless the entire system is properly designed.

Connection Fittings

There are various connection fittings available for Copeland Scroll refrigeration compressors. The various options are shown in **Table 8**.

Three Phase Scroll Compressors – Directional Dependents

Scroll compressors are directional dependent; i.e. they will compress in one rotational direction only. Three phase Scrolls will rotate in either direction depending on power phasing. Since there is a 50/50 chance of connected power being “backwards”, contractors should be warned of this. Appropriate instructions or notices should be provided by the OEM. To eliminate the possibility of reverse rotation a Copeland Phase Control line monitor, P/N 085-0160-00, or other phase monitor is recommended.

Verification of proper rotation can be made by observing that the suction pressure drops and the discharge pressure rises when the compressor is energized. Additionally, if operated in reverse the compressor is noisier and its current draw is substantially reduced compared to tabulated values.

Model	Rotalock Spud Connection		Stub Connection	
	Suction	Discharge	Suction	Discharge
ZB50	1-3/4 - 12	1-1/4 - 12	1-1/8"	7/8"
ZB58	1-3/4 - 12	1-1/4 - 12	1-1/8"	7/8"
ZB66	1-3/4 - 12	1-1/4 - 12	1-3/8"	7/8"
ZB76	1-3/4 - 12	1-1/4 - 12	1-3/8"	7/8"
ZB88	1-3/4 - 12	1-1/4 - 12	1-3/8"	7/8"
ZB95	1-3/4 - 12	1-1/4 - 12	1-3/8"	7/8"
ZB114	1-3/4 - 12	1-1/4 - 12	1-3/8"	7/8"
ZB56	1-3/4 - 12	1-1/4 - 12	not offered	
ZB68	1-3/4 - 12	1-1/4 - 12	not offered	
ZB75	1-3/4 - 12	1-1/4 - 12	not offered	
ZB92	1-3/4 - 12	1-1/4 - 12	not offered	
ZB11M	2-1/4 - 12	1-3/4 - 12	not offered	

Compressor Module Troubleshooting (continued)

I

Motor Protection*

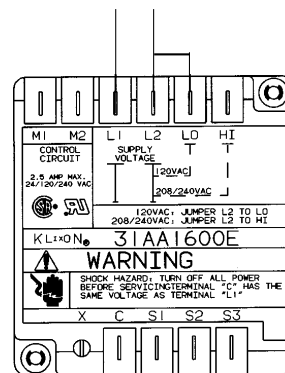
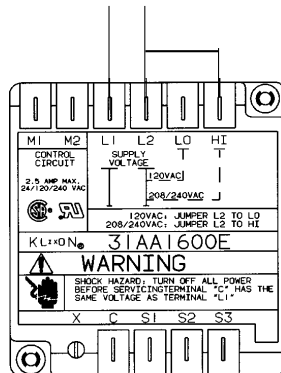
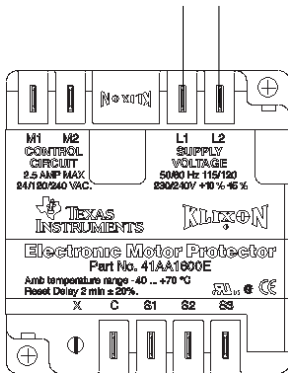

*This document is provided courtesy of Emerson Climate Technologies. This document may be updated regularly. Go to www.EmersonClimate.com to check for the most recent materials.

Motor Protection (continued)

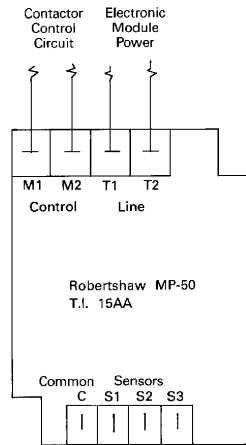

I

I

	—	—
--	---	---

Motor Protection (continued)

I

o o o

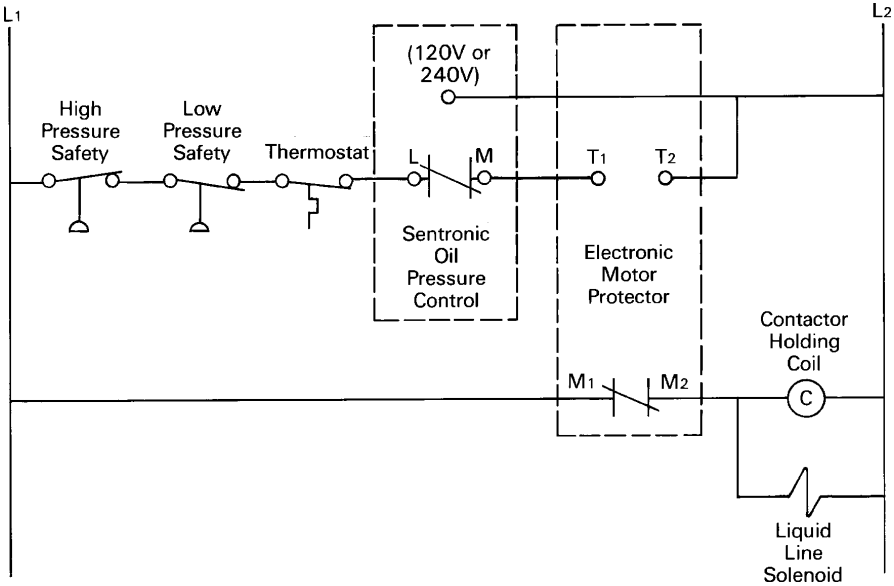

Motor Protection (continued)

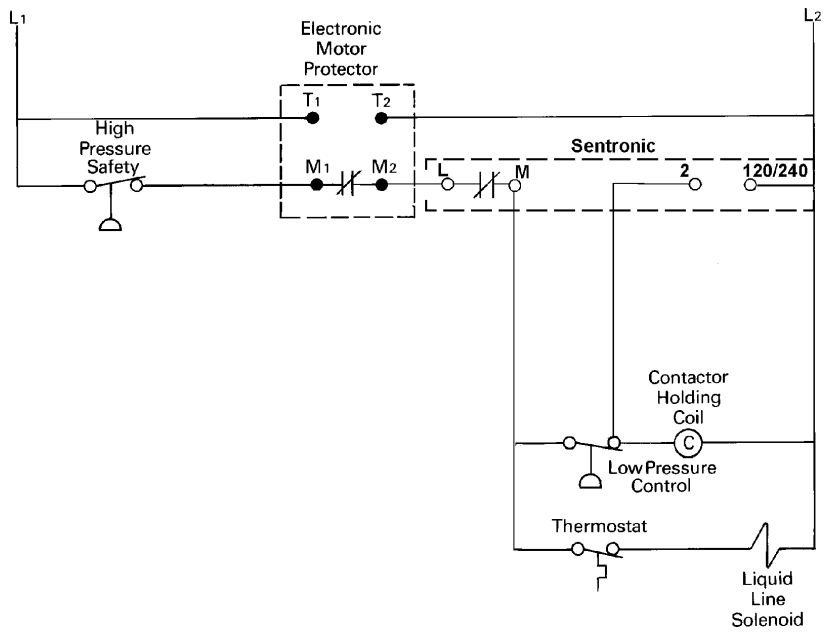

Motor Protection (continued)

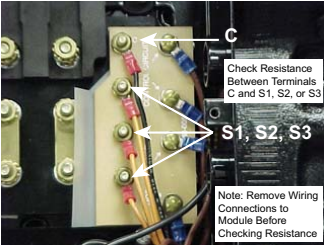

Motor Protection (continued)

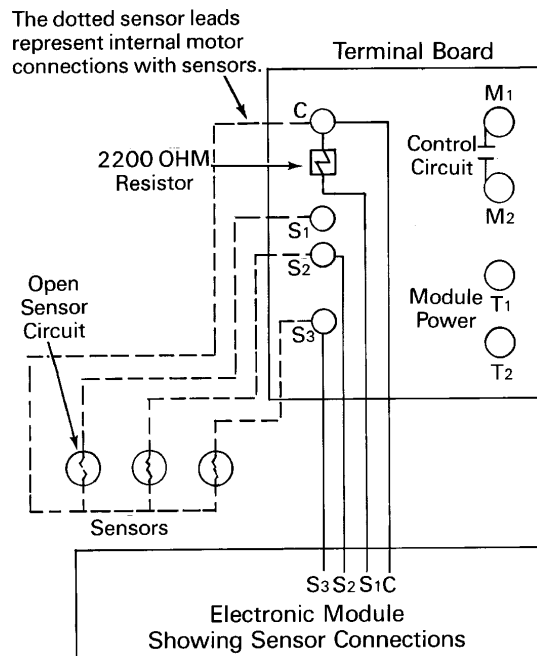

EarthSmart Chiller- Serial Modbus Communications

The EarthSmart Chiller has the capability of communicating on a plant-wide Modbus communication network. Conair recommends that single twisted pair cable of at least 24 AWG with a ground sheath and sink cable should be used for all Modbus communications. The EarthSmart Chiller has an isolated ground connection to the Modbus communication card, it is advised that the ground wire be terminated on both the Modbus master and slave side (With true ground local to the master). The DB-9 terminal connection should match the following table.

EIA/RS-485 Parameters

Baud Rate	Bits	Parity	Stop Bits
2400	8	Non (N)	1
4800		Even (E)	
9600		Odd (O)	
19200			

EIA/RS-485 Communications Connections

Communication Name	DB-9 Connection Pin
RX - A	2
TX - B	3
GND Sheath	5

See the charts beginning on the next page to read/write to the desired Modbus holding register address. All registers are configured as integer type. Process variables (temperature and setpoints) are stored as integers with scaling factors. Before these values can be read or written to the control the appropriate scaling factor must be applied. All process variables are stored in degree Celsius. Some special registers contain “bit oriented” information, such as alarms. In order to read these registers correctly, the Modbus master (or PLC, embedded controller, etc.) should perform a “bit mask” to the incoming integer value to strip the information required. Some critical parameter addresses are read only. A “Quick Block” grouping that was created pertains all of the most commonly used registers, if required, using this block can increase network speed.

Optional Modbus communications kits are available for field retrofit.

Contact Conair Parts
 (800) 458 1960
 From outside of the
 United States, call:
 (814) 437 6861

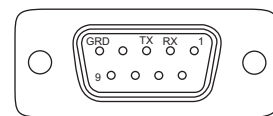

Front of DB-9 Connector
 Outside of EarthSmart Electrical Panel

NOTE: See [Operation section entitled, Setting Serial Modbus Communication ID and Adjusting Serial Baud Rate](#), to configure the serial Modbus connection for the EarthSmart Chiller.

EarthSmart Chiller- Ethernet Communications

Optional Ethernet communications kits are available for field retrofit.

Contact Conair Parts
 (800) 458 1960
 From outside of the
 United States, call:
 (814) 437 6861

The EarthSmart Chiller has the capability of communicating on a plant-wide Ethernet communication network. Modbus/TCP is a protocol that takes the basic serial Modbus command set and applies it to the Ethernet standard via TCP/IP protocol. This is useful for applications that require communicating to several different protocol standards on the same network.

Conair recommends that shielded industrial grade CAT-5e Ethernet cable be used for all communication links. A field connectable Ethernet terminal is included with the option, which connects to the panel connection to create an IP-65 seal. A protective lantern cap is included with the Ethernet Communications option; this cap should be used when no cable is inserted to help prevent contamination.

Default Ethernet Parameters:

IP Address, Subnet
DHCP Assigned, 255.255.255.0

Ethernet Communication T-568B Standard

RJ45 Pin #	Wire Color (T569B)	10 Base-T Signal 100 Base-TX Signal
1	White/Orange	Transmit+
2	Orange	Transmit-
3	White/Green	Receive+
4	Blue	Unused
5	White/Blue	Unused
6	Green	Receive-
7	White/Brown	Unused
8	Brown	Unused

EarthSmart Chiller- Ethernet Communications (continued)

To configure the EarthSmart Chiller for your network:

- 1** Download “Lantronix DeviceInstaller” from <http://www.lantronix.com/>.
 - 2** Follow the on screen instructions to install the program on to your PC.
 - 3** Check to ensure, that the Chiller is powered on and connected to your network. Within “Lantronix DeviceInstaller”, use the “Search for New Devices” button.
- 1** Select the EarthSmart Chiller, you wish to configure, and then use the “Assign New IP” button to adjust the network parameters to match your network.

See the charts beginning on the next page to read/write to the desired Modbus holding register address. All registers are configured as integer type. Process variables (temperature and setpoints) are stored as integers with scaling factors. Before these values can be read or written to the control the appropriate scaling factor must be applied. All process variables are stored in degree Celsius. Some special registers contain “bit oriented” information, such as alarms. In order to read these registers correctly, the Modbus master (or PLC, embedded controller, etc.) should perform a “bit mask” to the incoming integer value to strip the information required. Some critical parameter addresses are read only. A “Quick Block” grouping that was created pertains all of the most commonly used registers, if required, using this block can increase network speed.

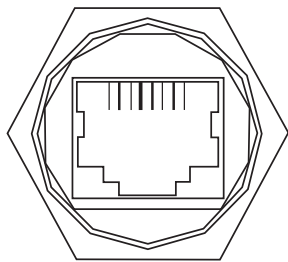

Front of Ethernet connector, located on the front of the EarthSmart Chiller’s electrical box.

Pressure Switch Settings

Both the ECW and ECA Series EarthSmart Chiller have pressure switches to turn on or off functions of the chiller. These settings should not be changed. Only replace a pressure switch with one that has the same exact pressure settings.

Pressure switch settings for both water and air-cooled chillers are listed below.

	ECW Series Chiller	ECA Series Chiller
Fan Cycling Switch Cut In	NA	450 psig
Fan Cycling Switch Cut out	NA	320 psig
Pressure Switch High	550 psig {38 bar}	550 psig {38 bar}
Pressure Switch Low*	85 psig {5.8 bar}	85 psig {5.8 bar}
Relief Valve	650 psig {44.8 bar}	650 psig {44.8 bar}

* Pressure switch low settings for the EarthSmart Chillers are based on 40°F {4.4°C} leaving water temperature. For leaving water temperatures between 20°F and 39°F {-6.7°C and 3.8°C}, the pressure switch low setting is 50 psig {3.4 bar}.

Resetting the High Pressure Switch

 **WARNING: Refrigerant hazard**

Only certified refrigerant technicians should examine and correct problems involving the refrigerant circuit.

 **CAUTION:** Always disconnect and lock out the main power sources before making electrical connections. Electrical connections should be made only by a qualified electrical technician.



IMPORTANT: Always refer to the wiring diagrams that came with your chiller to locate specific electrical components. Illustrations in the User Guide are intended to be representative only.

The high refrigeration safety pressure switch shuts off the compressor immediately when the high refrigeration pressure reaches 550 PSI {37.9 bar} without going through pump down during a low pressure cycle. If the high pressure switch trips, it must be manually reset by pressing the “**Reset**” button on the switch. The compressor can start immediately when this is reset so caution should be exercised.

To reset the high refrigeration safety switch:

- 1 Be sure the main power is disconnected** and the chiller is locked out. Always disconnect/unplug and lockout the main power source before opening the unit for servicing.
- 2 Remove the chiller’s left-side panel**, as viewed from the control.
- 3 Locate the high refrigeration safety switch.**
- 4 Push the “Reset” button.**
- 5 Replace the chiller’s left-side panel**, as viewed from the control.
- 6 Reapply main power.**